

# Dell EMC PowerEdge R640

## Installation and Service Manual

## Notes, cautions, and warnings

 **NOTE:** A NOTE indicates important information that helps you make better use of your product.

 **CAUTION:** A CAUTION indicates either potential damage to hardware or loss of data and tells you how to avoid the problem.

 **WARNING:** A WARNING indicates a potential for property damage, personal injury, or death.

<b>Chapter 1: Dell EMC PowerEdge R640 overview.....</b>	<b>7</b>
Supported configurations for PowerEdge R640.....	7
Front view of the system.....	9
Left control panel view.....	13
Right control panel view.....	15
Back view of the system.....	17
NIC indicator codes.....	21
Power supply unit indicator codes.....	21
Drive indicator codes.....	23
LCD panel.....	24
Viewing Home screen.....	25
Setup menu.....	25
View menu.....	25
Locating the Service Tag of your system.....	26
System information label.....	26
<b>Chapter 2: Documentation resources.....</b>	<b>29</b>
<b>Chapter 3: Initial system setup and configuration.....</b>	<b>31</b>
Setting up your system.....	31
iDRAC configuration.....	31
Options to set up iDRAC IP address.....	31
Log in to iDRAC.....	32
Options to install the operating system.....	32
Methods to download firmware and drivers.....	32
Downloading drivers and firmware.....	33
<b>Chapter 4: Installing and removing system components .....</b>	<b>34</b>
Safety instructions.....	34
Before working inside your system.....	35
After working inside your system.....	35
Recommended tools.....	35
Optional front bezel.....	36
Removing the front bezel.....	36
Installing the front bezel.....	36
System cover.....	37
Removing the system cover.....	37
Installing the system cover.....	38
Drives.....	39
Removing a drive blank.....	39
Installing a drive blank.....	40
Removing a drive carrier.....	40
Installing a drive carrier.....	41
Removing the drive from the drive carrier.....	42

Installing a drive into the drive carrier.....	43
Backplane cover.....	44
Removing the backplane cover.....	44
Installing the backplane cover.....	45
Inside the system.....	46
Air shroud.....	49
Removing the air shroud.....	49
Installing the air shroud.....	49
Cooling fans.....	50
Removing a cooling fan.....	50
Installing a cooling fan.....	51
System memory.....	52
System memory guidelines.....	52
General memory module installation guidelines.....	53
NVDIMM-N memory module installation guidelines .....	54
PMem installation guidelines .....	58
Mode-specific guidelines.....	59
Removing a memory module.....	62
Installing a memory module.....	63
NVDIMM-N battery.....	64
Removing the NVDIMM-N battery.....	64
Installing the NVDIMM-N battery.....	65
Processors and heat sinks.....	65
Removing a processor and heat sink module.....	65
Removing the processor from the processor and heat sink module.....	66
Installing the processor into a processor and heat sink module.....	67
Installing a processor and heat sink module.....	70
Expansion cards and expansion card risers.....	71
Expansion bus specifications.....	71
Removing an expansion card riser.....	76
Installing an expansion card riser.....	78
Removing expansion card from the expansion card riser.....	80
Installing an expansion card into expansion card riser.....	83
M.2 SSD module.....	85
Removing the M.2 SSD module.....	85
Installing the M.2 SSD module.....	86
Optional IDSDM or vFlash module.....	87
Removing the optional IDSDM or vFlash card.....	87
Installing optional IDSDM or vFlash card.....	88
Optional IDSDM or vFlash module.....	89
Removing the MicroSD card.....	89
Installing the MicroSD card.....	90
Network daughter card.....	91
Removing the network daughter card.....	91
Installing the network daughter card.....	92
Integrated storage controller card.....	93
Removing the integrated storage controller card.....	93
Installing the integrated storage controller card.....	94
Backplane.....	96
Backplane details.....	96

Removing the backplane cover.....	97
Installing the backplane.....	97
Removing the 2.5 inch drive rear backplane.....	98
Installing the 2.5 inch drive rear backplane.....	99
Cable routing.....	101
SAS expander card.....	110
Removing the SAS expander card.....	110
Installing the SAS expander card.....	111
Rear drive cage.....	112
Removing the rear drive cage.....	112
Installing the rear drive cage.....	113
System battery.....	114
Replacing the system battery.....	114
USB module.....	115
Removing the USB module.....	115
Installing the USB module.....	116
VGA module.....	116
Removing the VGA module.....	116
Installing the VGA module.....	117
Optional internal USB memory key.....	118
Replacing the optional internal USB memory key.....	118
Optical drive (optional).....	119
Removing the optical drive.....	119
Installing the optical drive.....	119
Power supply units.....	120
Hot spare feature.....	121
Removing a power supply unit blank.....	121
Installing a power supply unit blank.....	121
Removing a power supply unit.....	122
Installing a power supply unit.....	123
Removing a DC power supply unit.....	123
Installing DC power supply unit.....	124
Wiring instructions for a DC power supply unit.....	124
System board.....	125
Removing the system board.....	125
Installing the system board.....	126
Trusted Platform Module.....	129
Upgrading the Trusted Platform Module.....	129
Initializing TPM for BitLocker users.....	130
Initializing the TPM 1.2 for TXT users.....	130
Initializing the TPM 2.0 for TXT users.....	130
Control panel.....	131
Removing the left control panel.....	131
Installing the left control panel.....	132
Removing the right control panel.....	133
Installing the right control panel.....	134
<b>Chapter 5: System diagnostics.....</b>	<b>135</b>
Dell Embedded System Diagnostics.....	135
Running the Embedded System Diagnostics from Boot Manager.....	135

Running the Embedded System Diagnostics from the Dell Lifecycle Controller.....	135
System diagnostic controls.....	135
<b>Chapter 6: Jumpers and connectors .....</b>	<b>137</b>
System board jumpers and connectors.....	137
System board jumper settings.....	139
Disabling forgotten password.....	139
<b>Chapter 7: Getting help.....</b>	<b>140</b>
Contacting Dell EMC.....	140
Documentation feedback.....	140
Accessing system information by using QRL.....	140
Quick Resource Locator for R640.....	141
Receiving automated support with SupportAssist .....	141
Recycling or End-of-Life service information.....	141

# Dell EMC PowerEdge R640 overview

The Dell EMC PowerEdge R640 system is a 1U rack server that supports up to:

- Two 2<sup>nd</sup> generation Intel Xeon Scalable Processors
- 24 DIMM slots
- 8 x 2.5-inch hard drives or 4 x 3.5-inch hard drives on the front panel, or 10 x 2.5-inch hard drives on the front panel with optional support for 2 x 2.5-inch hard drives on the back panel
- Two AC or DC redundant power supply units

 **NOTE:** All instances of SAS, SATA hard drives, SSDs, NVMe drives are referred to as drives in this document, unless specified otherwise.

For more information, see the Dell EMC PowerEdge R640 Technical Specifications on the product documentation page.

## Topics:

- [Supported configurations for PowerEdge R640](#)
- [Front view of the system](#)
- [Back view of the system](#)
- [Drive indicator codes](#)
- [LCD panel](#)
- [Locating the Service Tag of your system](#)
- [System information label](#)

## Supported configurations for PowerEdge R640

The PowerEdge R640 system supports the following configurations:

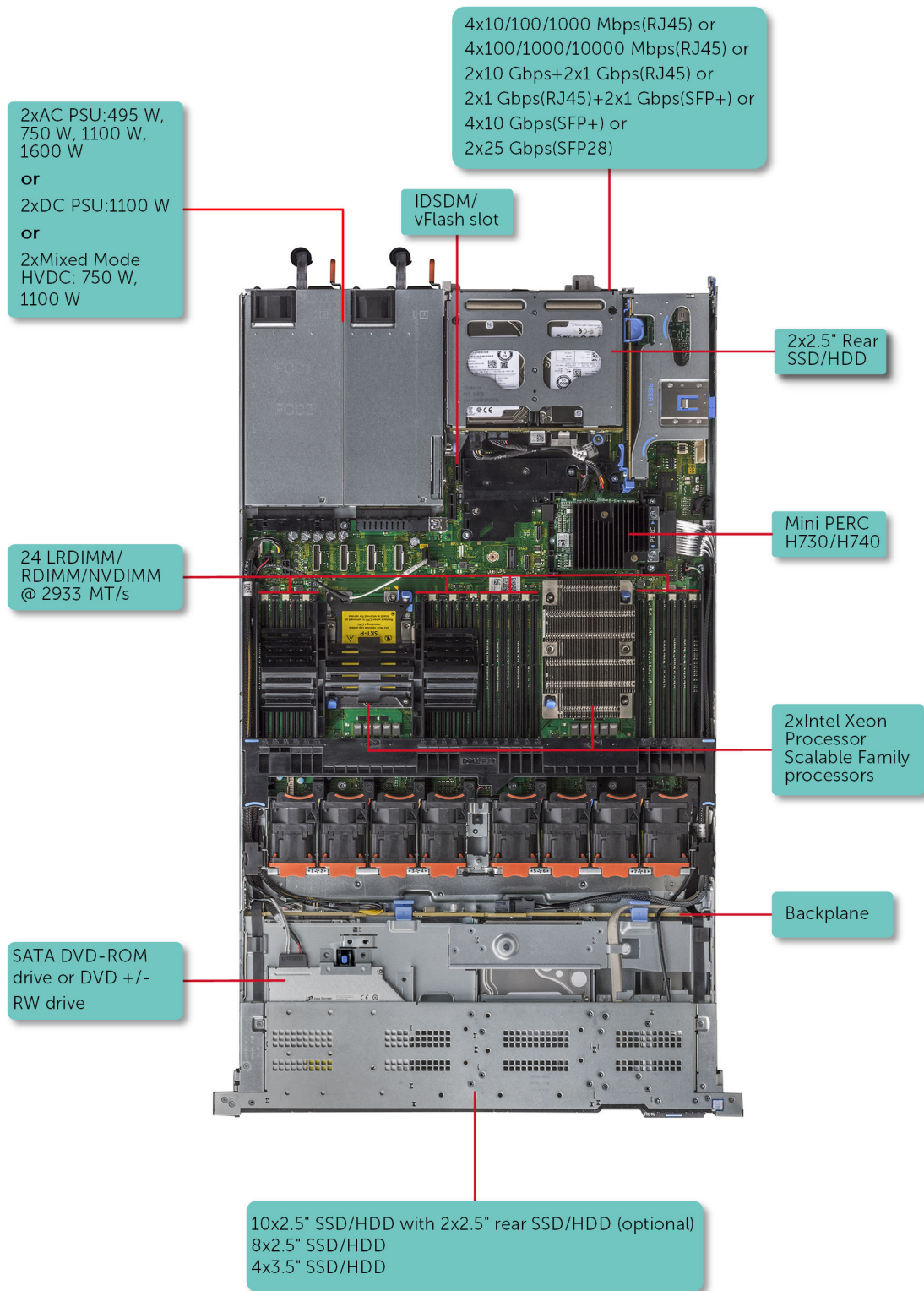

**Figure 1. Supported configurations for PowerEdge R640**



# Front view of the system

The front view displays the features available on the front of the system.

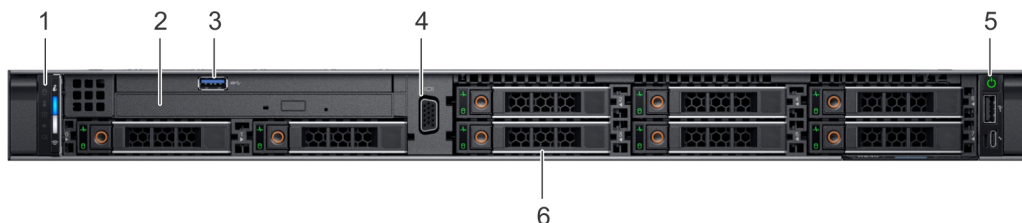



Figure 2. Front view of 8 x 2.5-inch drive system

Table 1. Features available on the front of the system

Item	Ports, panels, and slots	Icon	Description
1	Left control panel	N/A	<p>Contains the system health and system ID, status LED, and the iDRAC Quick Sync 2 (wireless) indicator.</p> <p><b>i</b> <b>NOTE:</b> The iDRAC Quick Sync 2 indicator is available only on certain configurations.</p> <ul style="list-style-type: none"> <li>Status LED: Enables you to identify any failed hardware components. There are up to five status LEDs and an overall system health LED (Chassis health and system ID) bar. For more information, see the <a href="#">Status LED indicators</a> section.</li> <li>Quick Sync 2 (wireless): Indicates a Quick Sync enabled system. The Quick Sync feature is optional. This feature allows management of the system by using mobile devices. This feature aggregates hardware or firmware inventory and various system level diagnostic and error information that can be used in troubleshooting the system. For more information, see the <i>Integrated Dell Remote Access Controller User's Guide</i> at <a href="http://www.dell.com/poweredgemanuals">www.dell.com/poweredgemanuals</a>.</li> </ul>
2	Optical drive (optional)	N/A	One optional slim SATA DVD-ROM drive or DVD+/-RW drive.

**Table 1. Features available on the front of the system (continued)**

Item	Ports, panels, and slots	Icon	Description
3	USB port (optional)		<p><b>i</b> <b>NOTE:</b> DVD devices are data only.</p> <p>The USB port is USB 3.0 compliant.</p>
4	VGA port		<p>Enables you to connect a display device to the system. For more information, see the <a href="http://www.dell.com/poweredgemanuals">www.dell.com/poweredgemanuals</a> section.</p>
5	Right control panel	N/A	<p>Contains the power button, USB port, iDRAC Direct micro port, and the iDRAC Direct status LED.</p>
6	Drive slots	N/A	<p>Enable you to install drives that are supported on your system. For more information about drives, see the <a href="http://www.dell.com/poweredgemanuals">www.dell.com/poweredgemanuals</a> section.</p>



**Figure 3. Front view of 4 x 3.5-inch drive system**

**Table 2. Features available on the front of the system**

Item	Ports, panels, and slots	Icon	Description
1	Left control panel	N/A	<p>Contains the system health and system ID, status LED, and the iDRAC Quick Sync 2 (wireless) indicator.</p> <p><b>i</b> <b>NOTE:</b> The iDRAC Quick Sync 2 indicator is available only on certain configurations.</p> <ul style="list-style-type: none"> <li>• Status LED: Enables you to identify any failed hardware components. There are up to five status LEDs and an overall system health LED (Chassis health and system ID) bar. For more information, see the <a href="#">Status LED indicators</a> section.</li> <li>• Quick Sync 2 (wireless): Indicates a Quick Sync</li> </ul>

**Table 2. Features available on the front of the system (continued)**



Item	Ports, panels, and slots	Icon	Description
			enabled system. The Quick Sync feature is optional. This feature allows management of the system by using mobile devices. This feature aggregates hardware or firmware inventory and various system level diagnostic and error information that can be used in troubleshooting the system. For more information, see the <i>Integrated Dell Remote Access Controller User's Guide</i> at <a href="http://www.dell.com/poweredgemanuals">www.dell.com/poweredgemanuals</a> .
2	Drive slots	N/A	Enable you to install drives that are supported on your system. For more information about drives, see the <a href="http://www.dell.com/poweredgemanuals">www.dell.com/poweredgemanuals</a> section.
3	Optical drive (optional)	N/A	One optional slim SATA DVD-ROM drive or DVD+/-RW drive. <b>i</b> <b>NOTE:</b> DVD devices are data only.
4	VGA port		Enables you to connect a display device to the system. For more information, see the <a href="http://www.dell.com/poweredgemanuals">www.dell.com/poweredgemanuals</a> section.
5	USB port (optional)		The USB port is USB 3.0 compliant.
6	Right control panel	N/A	Contains the power button, USB port, iDRAC Direct micro port, and the iDRAC Direct status LED.
7	Information tag	N/A	The Information Tag is a slide-out label panel that contains system information such as Service Tag, NIC, MAC address, and so on. If you have opted for the secure default access to iDRAC, the Information tag also contains the iDRAC secure default password.



Figure 4. Front view of 10 x 2.5-inch drive system

Table 3. Features available on the front of the system

Item	Ports, panels, and slots	Icon	Description
1	Left control panel	N/A	<p>Contains the system health and system ID, status LED, and the iDRAC Quick Sync 2 (wireless) indicator.</p> <p><b>NOTE:</b> The iDRAC Quick Sync 2 indicator is available only on certain configurations.</p> <ul style="list-style-type: none"> <li>• Status LED: Enables you to identify any failed hardware components. There are up to five status LEDs and an overall system health LED (Chassis health and system ID) bar. For more information, see the <a href="#">Status LED indicators</a> section.</li> <li>• Quick Sync 2 (wireless): Indicates a Quick Sync enabled system. The Quick Sync feature is optional. This feature allows management of the system by using mobile devices. This feature aggregates hardware or firmware inventory and various system level diagnostic and error information that can be used in troubleshooting the system. For more information, see the <i>Integrated Dell Remote Access Controller User's Guide</i> at <a href="http://www.dell.com/poweredgemanuals">www.dell.com/poweredgemanuals</a>.</li> </ul>
2	Drive slots	N/A	Enable you to install drives that are supported on your system. For more information about drives, see the Technical specifications section.
3	VGA port		Enables you to connect a display device to the system. For more information, see the <a href="http://www.dell.com/poweredgemanuals">www.dell.com/poweredgemanuals</a> section.
4	Right control panel	N/A	Contains the power button, USB port, iDRAC Direct micro port, and the iDRAC Direct status LED.
5	Information tag	N/A	The Information Tag is a slide-out label panel that contains system information such as Service Tag, NIC, MAC address, and so on. If you have opted for the secure default access to iDRAC, the Information tag also contains the iDRAC secure default password.

For more information, see the Dell EMC PowerEdge R640 Technical Specifications on the product documentation page.

## Left control panel view

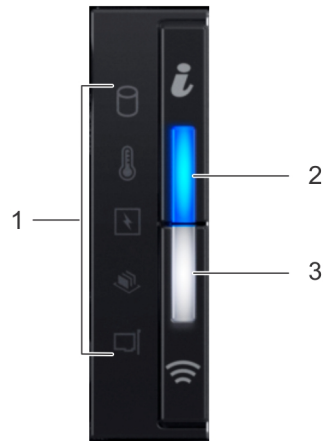

Figure 5. Left control panel with optional iDRAC Quick Sync 2.0 indicator

Table 4. Left control panel

Item	Indicator or button	Icon	Description
1	Status LED indicators	N/A	Indicate the status of the system. For more information, see the <a href="#">Status LED indicators</a> section.
2	System health and system ID indicator		Indicates the system health. For more information, see the <a href="#">System health and system ID indicator codes</a> section.
3	iDRAC Quick Sync 2 wireless indicator (optional) <b>NOTE:</b> iDRAC Quick Sync 2 wireless indicator is available only on certain configurations.		Indicates if the iDRAC Quick Sync 2 wireless option is activated. The Quick Sync 2 feature allows management of the system using mobile devices. This feature aggregates hardware/firmware inventory and various system level diagnostic/error information that can be used in troubleshooting the system. You can access system inventory, Dell EMC Lifecycle Controller logs or system logs, system health status, and also configure iDRAC, BIOS, and networking parameters. You can also launch the virtual Keyboard, Video, and Mouse (KVM) viewer and virtual Kernel based Virtual Machine (KVM), on a supported mobile device. <a href="http://www.dell.com/poweredgemanuals">www.dell.com/poweredgemanuals</a>



## Status LED indicators

**NOTE:** The indicators display solid amber if any error occurs.

Table 5. Status LED indicators and descriptions

Icon	Description	Condition	Corrective action
	Drive indicator	The indicator turns solid amber if there is a drive error.	<ul style="list-style-type: none"> <li>Check the System Event Log to determine if the drive has an error.</li> <li>Run the appropriate Online Diagnostics test. Restart the system and run embedded diagnostics (ePSA).</li> <li>If the drives are configured in a RAID array, restart the system, and enter the host adapter configuration utility program.</li> </ul>
	Temperature indicator	The indicator turns solid amber if the system experiences a thermal error (for example, the ambient temperature is out of range or there is a fan failure).	Ensure that none of the following conditions exist: <ul style="list-style-type: none"> <li>A cooling fan has been removed or has failed.</li> <li>System cover, air shroud, memory module blank, or back filler bracket is removed.</li> <li>Ambient temperature is too high.</li> </ul>

**Table 5. Status LED indicators and descriptions (continued)**

Icon	Description	Condition	Corrective action
	Electrical indicator	The indicator turns solid amber if the system experiences an electrical error (for example, voltage out of range, or a failed power supply unit (PSU) or voltage regulator).	<ul style="list-style-type: none"> <li>External airflow is obstructed.</li> </ul> If the problem persists, see <a href="#">Getting help</a> . Check the System Event Log or system messages for the specific issue. If it is due to a problem with the PSU, check the LED on the PSU. Reseat the PSU. If the problem persists, see <a href="#">Getting help</a> .
	Memory indicator	The indicator turns solid amber if a memory error occurs.	Check the System Event Log or system messages for the location of the failed memory. Reseat the memory module. If the problem persists, see <a href="#">Getting help</a> .
	PCIe indicator	The indicator turns solid amber if a PCIe card experiences an error.	Restart the system. Update any required drivers for the PCIe card. Reinstall the card. If the problem persists, see <a href="#">Getting help</a> .

## System health and system ID indicator codes

The system health and system ID indicator is located on the left control panel of your system.

### System health and system ID indicators



**Table 6. System health and system ID indicator codes**

System health and system ID indicator code	Condition
Solid blue	Indicates that the system is turned on, system is healthy, and system ID mode is not active. Press the system health and system ID button to switch to system ID mode.
Blinking blue	Indicates that the system ID mode is active. Press the system health and system ID button to switch to system health mode.
Solid amber	Indicates that the system is in fail-safe mode. If the problem persists, see the <a href="#">Getting help</a> section.
Blinking amber	Indicates that the system is experiencing a fault. Check the System Event Log or the LCD panel, if available on the bezel, for specific error messages. For information about the event and error messages generated by the system firmware and agents that monitor system components, go to <a href="http://qrl.dell.com">qrl.dell.com</a> > <b>Look Up</b> > <b>Error Code</b> , type the error code, and then click <b>Look it up</b> .

## iDRAC Quick Sync 2 indicator codes

iDRAC Quick Sync 2 module (optional) is located on the left control panel of your system.

### iDRAC Quick Sync 2 indicators



**Table 7. iDRAC Quick Sync 2 indicators and descriptions**

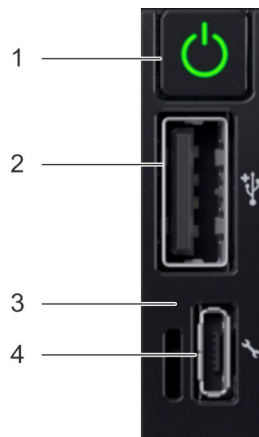

iDRAC Quick Sync 2 indicator code	Condition	Corrective action
Off (default state)	Indicates that the iDRAC Quick Sync 2 feature is turned off. Press the iDRAC Quick Sync 2 button to turn on the iDRAC Quick Sync 2 feature.	If the LED fails to turn on, reseal the left control panel flex cable and check. If the problem persists, see the <a href="#">Getting help</a> section.
Solid white	Indicates that iDRAC Quick Sync 2 is ready to communicate. Press the iDRAC Quick Sync 2 button to turn off.	If the LED fails to turn off, restart the system. If the problem persists, see the <a href="#">Getting help</a> section.
Blinks white rapidly	Indicates data transfer activity.	If the indicator continues to blink indefinitely, see the <a href="#">Getting help</a> section.
Blinks white slowly	Indicates that firmware update is in progress.	If the indicator continues to blink indefinitely, see the <a href="#">Getting help</a> section.
Blinks white five times rapidly and then turns off	Indicates that the iDRAC Quick Sync 2 feature is disabled.	Check if iDRAC Quick Sync 2 feature is configured to be disabled by iDRAC. If the problem persists, see the <a href="#">Getting help</a> section. <a href="http://www.dell.com/poweredgemanuals">www.dell.com/poweredgemanuals</a> or <i>Dell OpenManage Server Administrator User's Guide</i> at <a href="https://www.dell.com/openmanagemanuals">https://www.dell.com/openmanagemanuals</a> .
Solid amber	Indicates that the system is in fail-safe mode.	Restart the system. If the problem persists, see the <a href="#">Getting help</a> section.
Blinking amber	Indicates that the iDRAC Quick Sync 2 hardware is not responding properly.	Restart the system. If the problem persists, see the <a href="#">Getting help</a> section.

## Right control panel view



**Figure 6. Right control panel**

**Table 8. Right control panel**

Item	Indicator or button	Icon	Description
1	Power button		Indicates if the system is powered on or off. Press the power button to manually power on or off the system.  <b>NOTE:</b> Press the power button to gracefully shut down an ACPI-compliant operating system.
2	USB port		The USB ports are 4-pin, 2.0-compliant. This port enables you to connect USB devices to the system.
3	iDRAC Direct LED	N/A	The iDRAC Direct LED indicator lights up to indicate that the iDRAC Direct port is actively connected to a device. For more information, see the <a href="#">iDRAC Quick Sync 2 indicator codes</a> on page 15 section.
4	iDRAC Direct port (Micro-AB USB)		The iDRAC Direct (Micro-AB USB) port enables you to access the iDRAC Direct (Micro-AB) features. For more information, see the <i>Integrated Dell Remote Access Controller User's Guide</i> at <a href="http://www.dell.com/poweredgemanuals">www.dell.com/poweredgemanuals</a> .

## iDRAC Direct LED indicator codes

The iDRAC Direct LED indicator lights up to indicate that the port is connected and is being used as a part of the iDRAC subsystem.

You can configure iDRAC Direct by using a USB to micro USB (type AB) cable, which you can connect to your laptop or tablet. The following table describes iDRAC Direct activity when the iDRAC Direct port is active:

**Table 9. iDRAC Direct LED indicator codes**

iDRAC Direct LED indicator code	Condition
Solid green for two seconds	Indicates that the laptop or tablet is connected.
Flashing green (on for two seconds and off for two seconds)	Indicates that the laptop or tablet connected is recognized.
Turns off	Indicates that the laptop or tablet is unplugged.



# Back view of the system

The back view displays the features available on the back of the system.

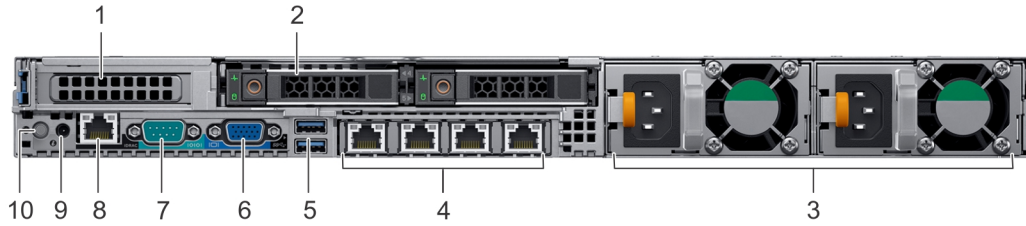







Figure 7. Back view of 2 x 2.5-inch drives with 1 PCIe expansion slot

Table 10. 2 X 2.5-inch drive system with 1 PCIe expansion slot

Item	Ports, panels, or slots	Icon	Description
1	PCIe expansion card slot	N/A	The expansion slot(s) enable you to connect PCI Express expansion cards. For more information on the expansion cards that are supported on your system, see the <a href="#">Expansion card guidelines</a> .
2	Drive slot (2)	N/A	Enable you to install drives that are supported on your system. For more information about drives, see the <a href="http://www.dell.com/poweredgemanuals">www.dell.com/poweredgemanuals</a> section.
3	Power supply unit (2)	N/A	For more information about the PSU configurations, see the <a href="http://www.dell.com/poweredgemanuals">www.dell.com/poweredgemanuals</a> section.
4	NIC port (4)		The NIC ports that are integrated on the network daughter card (NDC) provide network connectivity. For more information about the supported configurations, see the <a href="http://www.dell.com/poweredgemanuals">www.dell.com/poweredgemanuals</a> section.
5	USB 3.0 port (2)		The USB ports are 9-pin and 3.0-compliant. These ports enable you to connect USB devices to the system.
6	VGA port		Enables you to connect a display device to the system. For more information, see the <a href="http://www.dell.com/poweredgemanuals">www.dell.com/poweredgemanuals</a> section.
7	Serial port		Enables you to connect a serial device to the system. For more information, see the <a href="http://www.dell.com/poweredgemanuals">www.dell.com/poweredgemanuals</a> section.

**Table 10. 2 X 2.5-inch drive system with 1 PCIe expansion slot (continued)**

Item	Ports, panels, or slots	Icon	Description
8	iDRAC9 dedicated network port		Use the iDRAC9 dedicated network port to securely access the embedded iDRAC on a separate management network, see the <i>Integrated Dell Remote Access Controller User's Guide</i> at <a href="http://www.dell.com/poweredgemanuals">www.dell.com/poweredgemanuals</a>
9	System status indicator cable port	N/A	Enables you to connect the status indicator cable and view system status when the CMA is installed.
10	System identification button		The System Identification (ID) button is available on the front and back of the systems. Press the button to identify a system in a rack by turning on the system ID button. You can also use the system ID button to reset iDRAC and to access BIOS using the step through mode.

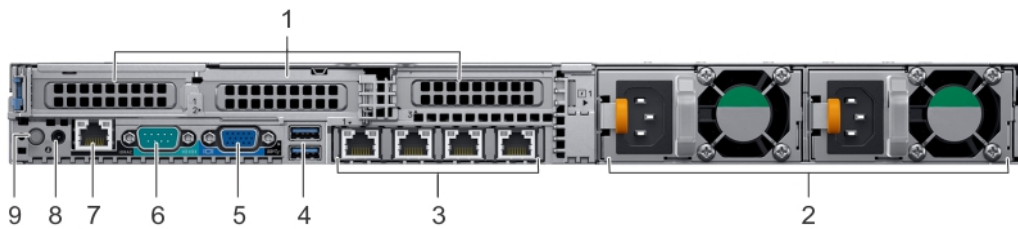





**Figure 8. Back view of system with 3 PCIe expansion slots**

**Table 11. 2 X 2.5-inch drive system with 3 PCIe expansion slot**

Item	Ports, panels, or slots	Icon	Description
1	PCIe expansion card slot(3)	N/A	The expansion slot(s) enable you to connect PCI Express expansion cards. For more information on the expansion cards that are supported on your system, see the <a href="#">Expansion card guidelines</a> .
2	Power supply unit (2)	N/A	For more information about the PSU configurations, see the <a href="http://www.dell.com/poweredgemanuals">www.dell.com/poweredgemanuals</a> section
3	NIC port (4)		The NIC ports that are integrated on the network daughter card (NDC) provide network connectivity. For more information about the supported configurations, see the <a href="http://www.dell.com/poweredgemanuals">www.dell.com/poweredgemanuals</a> section.

**Table 11. 2 X 2.5-inch drive system with 3 PCIe expansion slot (continued)**

Item	Ports, panels, or slots	Icon	Description
4	USB 3.0 port (2)		The USB ports are 9-pin and 3.0-compliant. These ports enable you to connect USB devices to the system.
5	VGA port		Enables you to connect a display device to the system. For more information, see the <a href="http://www.dell.com/poweredgemanuals">www.dell.com/poweredgemanuals</a> section.
6	Serial port		Enables you to connect a serial device to the system. For more information, see the <a href="http://www.dell.com/poweredgemanuals">www.dell.com/poweredgemanuals</a> section.
7	iDRAC9 dedicated network port		Use the iDRAC9 dedicated network port to securely access the embedded iDRAC on a separate management network, see the <a href="http://www.dell.com/poweredgemanuals">www.dell.com/poweredgemanuals</a>
8	System status indicator cable port	N/A	Enables you to connect the status indicator cable and view system status when the CMA is installed.
9	System identification button		The System Identification (ID) button is available on the front and back of the systems. Press the button to identify a system in a rack by turning on the system ID button. You can also use the system ID button to reset iDRAC and to access BIOS using the step through mode.

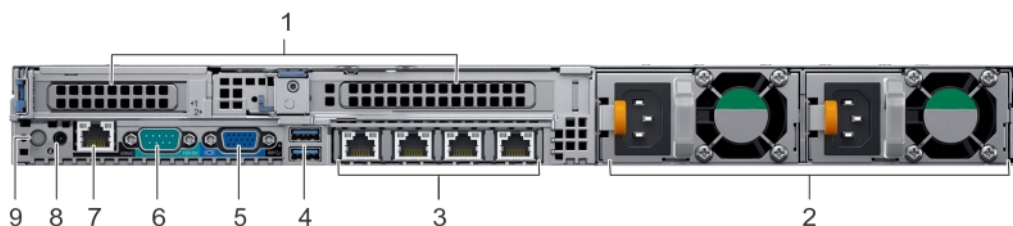

**Figure 9. Back view of system with 2 PCIe expansion slots**

**Table 12. 2 X 2.5-inch drive system with 2 PCIe expansion slot**

Item	Ports, panels, or slots	Icon	Description
1	PCIe expansion card slot (2)	N/A	The expansion slot(s) enable you to connect PCI Express expansion cards. For more information on the expansion cards that are supported

**Table 12. 2 X 2.5-inch drive system with 2 PCIe expansion slot (continued)**

Item	Ports, panels, or slots	Icon	Description
2	Power supply unit (2)	N/A	on your system, see the <a href="#">Expansion card guidelines</a> . For more information about the PSU configurations, see the <a href="#">Technical specifications</a> section
3	NIC port (4)		The NIC ports that are integrated on the network daughter card (NDC) provide network connectivity. For more information about the supported configurations, see the <a href="http://www.dell.com/poweredgemanuals">www.dell.com/poweredgemanuals</a> section.
4	USB 3.0 port (2)		The USB ports are 9-pin and 3.0-compliant. These ports enable you to connect USB devices to the system.
5	VGA port		Enables you to connect a display device to the system. For more information, see the <a href="http://www.dell.com/poweredgemanuals">www.dell.com/poweredgemanuals</a> section.
6	Serial port		Enables you to connect a serial device to the system. For more information, see the <a href="http://www.dell.com/poweredgemanuals">www.dell.com/poweredgemanuals</a> section.
7	iDRAC9 dedicated network port		Use the iDRAC9 dedicated network port to securely access the embedded iDRAC on a separate management network, see the <a href="http://www.dell.com/poweredgemanuals">www.dell.com/poweredgemanuals</a>
8	System status indicator cable port	N/A	Enables you to connect the status indicator cable and view system status when the CMA is installed.
9	System identification button		The System Identification (ID) button is available on the front and back of the systems. Press the button to identify a system in a rack by turning on the system ID button. You can also use the system ID button to reset iDRAC and to access BIOS using the step through mode.

For more information, see the Dell EMC PowerEdge R640 Technical Specifications on the product documentation page.

## NIC indicator codes

Each NIC on the back of the system has indicators that provide information about the activity and link status. The activity LED indicator indicates if data is flowing through the NIC, and the link LED indicator indicates the speed of the connected network.

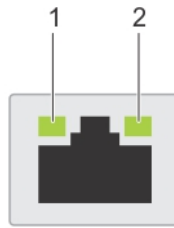

**Figure 10. NIC indicator codes**

1. Link LED indicator
2. Activity LED indicator

**Table 13. NIC indicator codes**

Status	Condition
Link and activity indicators are off.	The NIC is not connected to the network.
Link indicator is green, and activity indicator is blinking green.	The NIC is connected to a valid network at its maximum port speed, and data is being sent or received.
Link indicator is amber, and activity indicator is blinking green.	The NIC is connected to a valid network at less than its maximum port speed, and data is being sent or received.
Link indicator is green, and activity indicator is off.	The NIC is connected to a valid network at its maximum port speed, and data is not being sent or received.
Link indicator is amber, and activity indicator is off.	The NIC is connected to a valid network at less than its maximum port speed, and data is not being sent or received.
Link indicator is blinking green, and activity is off.	NIC identify is enabled through the NIC configuration utility.

## Power supply unit indicator codes

AC power supply units (PSUs) have an illuminated translucent handle that serves as an indicator. The DC PSUs have an LED that serves as an indicator. The indicator shows whether power is present or if a power fault has occurred.

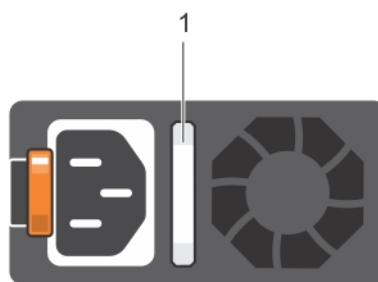

**Figure 11. AC PSU status indicator**

1. AC PSU status indicator/handle

**Table 14. AC PSU status indicator codes**

Power indicator codes	Condition
Green	A valid power source is connected to the PSU and the PSU is operational.
Blinking amber	Indicates a problem with the PSU.
Not illuminated	Power is not connected to the PSU.

**Table 14. AC PSU status indicator codes (continued)**

Power indicator codes	Condition
Blinking green	<p>When the firmware of the PSU is being updated, the PSU handle blinks green.</p> <p><b>CAUTION:</b> Do not disconnect the power cord or unplug the PSU when updating firmware. If firmware update is interrupted, the PSUs do not function.</p>
Blinking green and turns off	<p>When hot-plugging a PSU, the PSU handle blinks green five times at a rate of 4 Hz and turns off. This indicates a PSU mismatch with respect to efficiency, feature set, health status, or supported voltage. If two PSUs are installed, both the PSUs must have the same type of label; for example, Extended Power Performance (EPP) label. Mixing PSUs from previous generations of PowerEdge servers is not supported, even if the PSUs have the same power rating. This results in a PSU mismatch condition or failure to turn the system on.</p> <p><b>CAUTION:</b> When correcting a PSU mismatch, replace only the PSU with the blinking indicator. Swapping the PSU to make a matched pair can result in an error condition and unexpected system shutdown. To change from a high output configuration to a low output configuration or vice versa, you must turn off the system. AC PSUs support both 240 V and 120 V input voltages with the exception of Titanium PSUs, which support only 240 V. When two identical PSUs receive different input voltages, they can output different wattages, and trigger a mismatch.</p> <p><b>CAUTION:</b> If two PSUs are used, they must be of the same type and have the same maximum output power. Combining AC and DC PSUs is not supported and triggers a mismatch.</p>

DC PSU status indicator

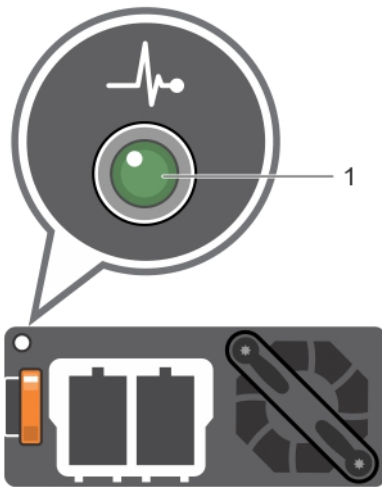

1. DC PSU status indicator

**Table 15. DC PSU status indicator codes**

Power indicator codes	Condition
Green	A valid power source is connected to the PSU and the PSU is operational.
Blinking amber	Indicates a problem with the PSU.
Not illuminated	Power is not connected to the PSU.
Blinking green	<p>When hot-plugging a PSU, the PSU indicator blinks green. This indicates that there is a PSU mismatch with respect to efficiency, feature set, health status, or supported voltage.</p> <p><b>CAUTION:</b> If two PSUs are installed, both the PSUs must have the same type of label; for example, Extended Power Performance (EPP) label. Mixing PSUs from previous generations of PowerEdge servers is not supported, even if the PSUs</p>

**Table 15. DC PSU status indicator codes (continued)**

Power indicator codes	Condition
	have the same power rating. This results in a PSU mismatch condition or failure to turn the system on.
△	<b>CAUTION:</b> When correcting a PSU mismatch, replace only the PSU with the blinking indicator. Swapping the PSU to make a matched pair can result in an error condition and unexpected system shutdown. To change from a High Output configuration to a Low Output configuration or vice versa, you must turn off the system.
△	<b>CAUTION:</b> If two PSUs are used, they must be of the same type and have the same maximum output power.
△	<b>CAUTION:</b> Combining AC and DC PSUs is not supported and triggers a mismatch.

## Drive indicator codes

Each drive carrier has an activity LED indicator and a status LED indicator. The indicators provide information about the current status of the drive. The activity LED indicator indicates whether the drive is currently in use or not. The status LED indicator indicates the power condition of the drive.



**Figure 12. Drive indicators on the drive and the mid drive tray backplane**

1. Drive activity LED indicator
2. Drive status LED indicator
3. Drive capacity label

**NOTE:** If the drive is in the Advanced Host Controller Interface (AHCI) mode, the status LED indicator does not turn on.

**Table 16. Drive indicator codes**

Drive status indicator code	Condition
Flashes green twice per second	Identifying drive or preparing for removal.
Off	Drive ready for removal. <b>NOTE:</b> The drive status indicator remains off until all drives are initialized after the system is turned on. Drives are not ready for removal during this time.
Flashes green, amber, and then turns off	Predicted drive failure.
Flashes amber four times per second	Drive failed.
Flashes green slowly	Drive rebuilding.

**Table 16. Drive indicator codes (continued)**

Drive status indicator code	Condition
Solid green	Drive online.
Flashes green for three seconds, amber for three seconds, and then turns off after six seconds	Rebuild stopped.

## LCD panel

The LCD panel provides system information, status, and error messages to indicate if the system is functioning correctly or requires attention. The LCD panel can also be used to configure or view the system's iDRAC IP address. For information about the event and error messages generated by the system firmware and agents that monitor system components, go to [qrl.dell.com](http://qrl.dell.com) > **Look Up** > **Error Code**, type the error code, and then click **Look it up**.

The LCD panel is available only on the optional front bezel. The optional front bezel is hot pluggable.

The statuses and conditions of the LCD panel are outlined here:

- The LCD backlight is white during normal operating conditions.
- When the system needs attention, the LCD backlight turns amber, and displays an error code followed by descriptive text.
  - ⓘ **NOTE:** If the system is connected to a power source and an error is detected, the LCD turns amber regardless of whether the system is turned on or off.
- When the system turns off and there are no errors, LCD enters the standby mode after five minutes of inactivity. Press any button on the LCD to turn it on.
- If the LCD panel stops responding, remove the bezel and reinstall it. If the problem persists, see the PowerEdge T640 Technical Specs at [www.dell.com/poweredgemanuals](http://www.dell.com/poweredgemanuals)
- The LCD backlight remains off if LCD messaging is turned off using the iDRAC utility, the LCD panel, or other tools.

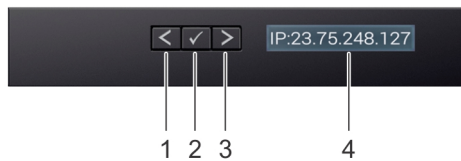

**Figure 13. LCD panel features**

**Table 17. LCD panel features**



Item	Button or display	Description
1	Left	Moves the cursor back in one-step increments.
2	Select	Selects the menu item highlighted by the cursor.
3	Right	Moves the cursor forward in one-step increments. During message scrolling: <ul style="list-style-type: none"> <li>• Press and hold the right button to increase scrolling speed.</li> <li>• Release the button to stop.</li> </ul> ⓘ <b>NOTE:</b> The display stops scrolling when the button is released. After 45 seconds of inactivity, the display starts scrolling.
4	LCD display	Displays system information, status, and error messages or iDRAC IP address.



## Viewing Home screen

The **Home** screen displays user-configurable information about the system. This screen is displayed during normal system operation when there are no status messages or errors. When the system turns off and there are no errors, LCD enters the standby mode after five minutes of inactivity. Press any button on the LCD to turn it on.

### Steps

1. To view the **Home** screen, press one of the three navigation buttons (Select, Left, or Right).
2. To navigate to the **Home** screen from another menu, complete the following steps:
  - a. Press and hold the navigation button until the up arrow  is displayed.
  - b. Navigate to the **Home** icon  using the up arrow .
  - c. Select the **Home** icon.
  - d. On the **Home** screen, press the **Select** button to enter the main menu.

## Setup menu

 **NOTE:** When you select an option in the **Setup** menu, you must confirm the option before proceeding to the next action.

Option	Description
<b>iDRAC</b>	Select <b>DHCP</b> or <b>Static IP</b> to configure the network mode. If <b>Static IP</b> is selected, the available fields are <b>IP</b> , <b>Subnet (Sub)</b> , and <b>Gateway (Gtw)</b> . Select <b>Setup DNS</b> to enable DNS and to view domain addresses. Two separate DNS entries are available.
<b>Set error</b>	Select <b>SEL</b> to view LCD error messages in a format that matches the IPMI description in the SEL. This enables you to match an LCD message with an SEL entry.  Select <b>Simple</b> to view LCD error messages in a simplified user-friendly description. For information about the event and error messages generated by the system firmware and agents that monitor system components, go to <a href="http://qrl.dell.com">qrl.dell.com</a> > <b>Look Up</b> > <b>Error Code</b> , type the error code, and then click <b>Look it up</b> .
<b>Set home</b>	Select the default information to be displayed on the <b>Home</b> screen. See View menu section for the options and option items that can be set as the default on the <b>Home</b> screen.

## View menu

 **NOTE:** When you select an option in the **View** menu, you must confirm the option before proceeding to the next action.

Option	Description
<b>iDRAC IP</b>	Displays the <b>IPv4</b> or <b>IPv6</b> addresses for iDRAC9. Addresses include <b>DNS (Primary and Secondary)</b> , <b>Gateway</b> , <b>IP</b> , and <b>Subnet</b> (IPv6 does not have Subnet).
<b>MAC</b>	Displays the MAC addresses for <b>iDRAC</b> , <b>iSCSI</b> , or <b>Network</b> devices.
<b>Name</b>	Displays the name of the <b>Host</b> , <b>Model</b> , or <b>User String</b> for the system.
<b>Number</b>	Displays the <b>Asset tag</b> or the <b>Service tag</b> for the system.
<b>Power</b>	Displays the power output of the system in BTU/hr or Watts. The display format can be configured in the <b>Set home</b> submenu of the <b>Setup</b> menu.
<b>Temperature</b>	Displays the temperature of the system in Celsius or Fahrenheit. The display format can be configured in the <b>Set home</b> submenu of the <b>Setup</b> menu.

# Locating the Service Tag of your system

You can identify your system using the unique Express Service Code and Service Tag. Pull out the information tag in front of the system to view the Express Service Code and Service Tag. Alternatively, the information may be on a sticker on the chassis of the system. The mini Enterprise Service Tag (EST) is found on the back of the system. This information is used by Dell EMC to route support calls to the appropriate personnel.

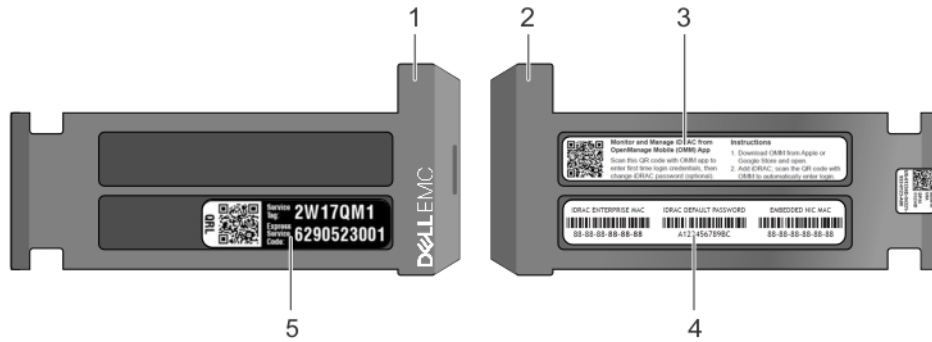
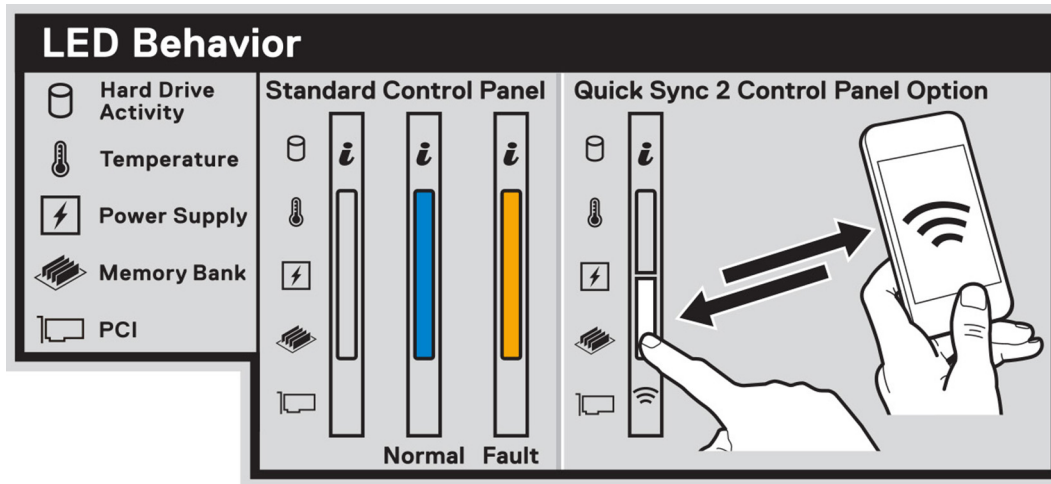

**Figure 14. Locating Service Tag of your system**

- 1. information tag (front view)
- 2. information tag (back view)
- 3. OpenManage Mobile (OMM) label
- 4. iDRAC MAC address and iDRAC secure password label
- 5. Service Tag

# System information label

## PowerEdge R640 – Front system information label



**Figure 15. LED behavior**

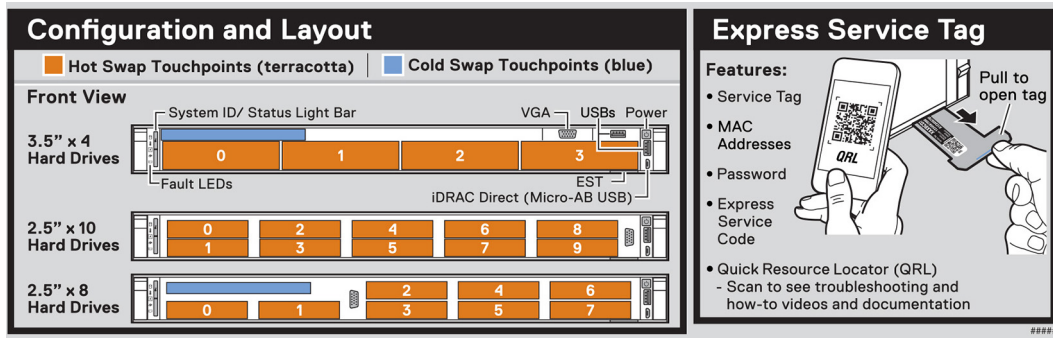

Figure 16. Configuration and layout and express service tag

## PowerEdge R640 – Service information

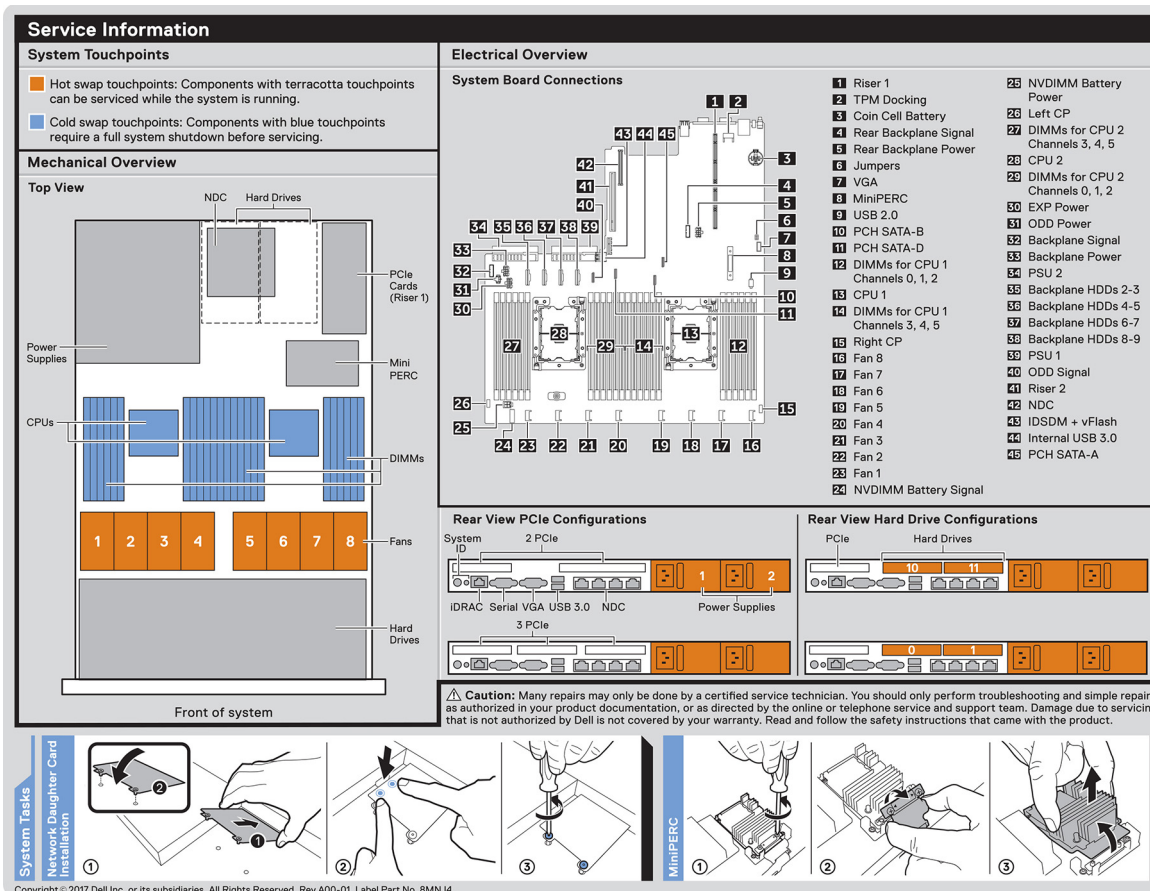
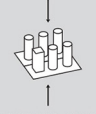







Figure 17. Service information, electrical overview, network daughter card and miniPERC installation

### Jumper Settings

Jumper	Setting	Description
 PWRD_EN	 (default)	BIOS password is enabled.
		BIOS password is disabled. iDRAC local access unlocked at next AC power cycle. iDRAC password reset is enabled in F2 iDRAC settings menu.
	 (default)	BIOS configuration settings retained at system boot.
 NVRAM_CLR	 (default)	BIOS configuration settings cleared at system boot.

Scan to see hardware servicing and software setup videos, how-to's, and documentation.



**Quick Resource Locator**  
Dell.com/GRL/Server/PER640

To learn more about this Dell product or to order additional or replacement parts, go to [Dell.com/support](http://Dell.com/support)

---

### Memory Information

**⚠ Caution:** Memory (DIMMs) and CPUs may be hot during servicing.

B6 B5 B4  
↓ B12 ↓ B11 ↓ B10



B1 B2 B3 A6 A5 A4  
↓ B7 ↓ B8 ↓ B9 ↓ A12 ↓ A11 ↓ A10

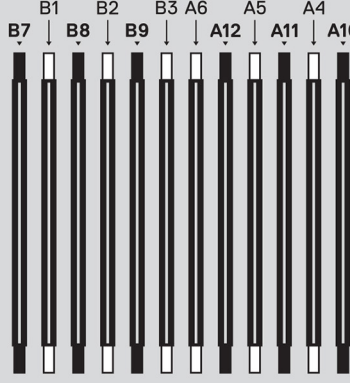

A1 A2 A3  
↓ A7 ↓ A8 ↓ A9

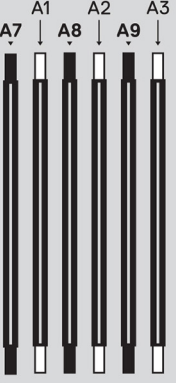

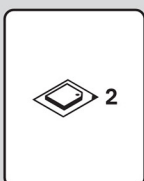

2

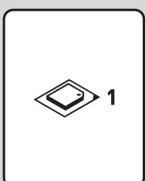

1

Configuration	Sequence
Memory-Optimized	1, 2, 3, 4, 5, 6, 7, 8, 9, 10, 11, 12
Mirroring	(1,2) (3,4) (5,6) (7,8) (9,10) (11,12)

Memory Sparring details are documented in the *Installation and Service Manual*.

---

#### NVDIMM Battery

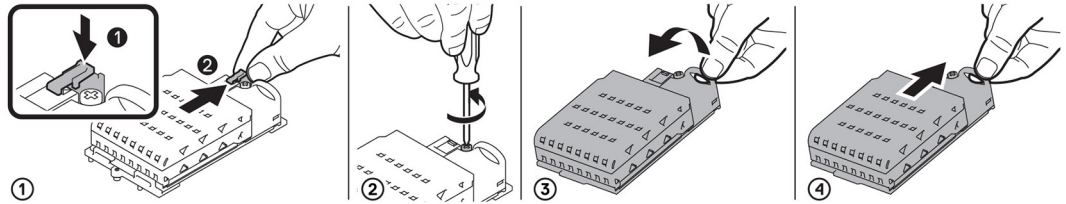

1. Push down the battery latch.
2. Turn the battery counter-clockwise.
3. Lift the battery out of the slot.
4. Push the battery up to lock it.

Figure 18. Memory information, jumper setting and NVDIMM battery removal

## Documentation resources

This section provides information about the documentation resources for your system.

To view the document that is listed in the documentation resources table:

- From the Dell EMC support site:
  1. Click the documentation link that is provided in the Location column in the table.
  2. Click the required product or product version.
-  **NOTE:** To locate the product name and model, see the front of your system.
- 3. On the Product Support page, click **Manuals & documents**.
- Using search engines:
  - Type the name and version of the document in the search box.

**Table 18. Documentation resources**

Task	Document	Location
Setting up your system	<p>For more information about installing and securing the system into a rack, see the Rail Installation Guide included with your rack solution.</p> <p>For information about setting up your system, see the <i>Getting Started Guide</i> document that is shipped with your system.</p>	<a href="https://www.dell.com/poweredgemanuals">https://www.dell.com/poweredgemanuals</a>
Configuring your system	<p>For information about the iDRAC features, configuring and logging in to iDRAC, and managing your system remotely, see the Integrated Dell Remote Access Controller User's Guide.</p> <p>For information about understanding Remote Access Controller Admin (RACADM) subcommands and supported RACADM interfaces, see the RACADM CLI Guide for iDRAC.</p> <p>For information about Redfish and its protocol, supported schema, and Redfish Eventing implemented in iDRAC, see the Redfish API Guide.</p> <p>For information about iDRAC property database group and object descriptions, see the Attribute Registry Guide.</p> <p>For information about Intel QuickAssist Technology, see the Integrated Dell Remote Access Controller User's Guide.</p>	<a href="https://www.dell.com/poweredgemanuals">https://www.dell.com/poweredgemanuals</a>
	<p>For information about earlier versions of the iDRAC documents.</p> <p>To identify the version of iDRAC available on your system, on the iDRAC web interface, click <b>? &gt; About</b>.</p>	<a href="https://www.dell.com/idracmanuals">https://www.dell.com/idracmanuals</a>
	For information about installing the operating system, see the operating system documentation.	<a href="https://www.dell.com/operatingsystemmanuals">https://www.dell.com/operatingsystemmanuals</a>

**Table 18. Documentation resources (continued)**

Task	Document	Location
	For information about updating drivers and firmware, see the Methods to download firmware and drivers section in this document.	<a href="http://www.dell.com/support/drivers">www.dell.com/support/drivers</a>
Managing your system	For information about system management software offered by Dell, see the Dell OpenManage Systems Management Overview Guide.	<a href="https://www.dell.com/poweredgemanuals">https://www.dell.com/poweredgemanuals</a>
	For information about setting up, using, and troubleshooting OpenManage, see the Dell OpenManage Server Administrator User's Guide.	<a href="http://www.dell.com/openmanagemanuals">www.dell.com/openmanagemanuals</a> > OpenManage Server Administrator
	For information about installing, using, and troubleshooting Dell OpenManage Enterprise, see the Dell OpenManage Enterprise User's Guide.	<a href="https://www.dell.com/openmanagemanuals">https://www.dell.com/openmanagemanuals</a>
	For information about installing and using Dell SupportAssist, see the Dell EMC SupportAssist Enterprise User's Guide.	<a href="https://www.dell.com/serviceabilitytools">https://www.dell.com/serviceabilitytools</a>
	For information about partner programs enterprise systems management, see the OpenManage Connections Enterprise Systems Management documents.	<a href="https://www.dell.com/openmanagemanuals">https://www.dell.com/openmanagemanuals</a>
Working with the Dell PowerEdge RAID controllers	For information about understanding the features of the Dell PowerEdge RAID controllers (PERC), Software RAID controllers, or BOSS card and deploying the cards, see the Storage controller documentation.	<a href="http://www.dell.com/storagecontrollermanuals">www.dell.com/storagecontrollermanuals</a>
Understanding event and error messages	For information about the event and error messages generated by the system firmware and agents that monitor system components, go to <a href="http://qrl.dell.com">qrl.dell.com</a> > <b>Look Up</b> > <b>Error Code</b> , type the error code, and then click <b>Look it up</b> .	<a href="http://www.dell.com/qrl">www.dell.com/qrl</a>
Troubleshooting your system	For information about identifying and troubleshooting the PowerEdge server issues, see the Server Troubleshooting Guide.	<a href="https://www.dell.com/poweredgemanuals">https://www.dell.com/poweredgemanuals</a>

# Initial system setup and configuration

## Topics:

- [Setting up your system](#)
- [iDRAC configuration](#)
- [Options to install the operating system](#)

## Setting up your system

Perform the following steps to set up your system:

### Steps

1. Unpack the system.
2. Install the system into the rack. For more information about installing the system into the rack, see the *Rail Installation Guide* at [www.dell.com/poweredgemanuals](http://www.dell.com/poweredgemanuals).
3. Connect the peripherals to the system.
4. Connect the system to its electrical outlet.
5. Power on the system by pressing the power button or by using iDRAC.
6. Power on the attached peripherals.

For more information about setting up your system, see the *Getting Started Guide* that shipped with your system.

For information on how to manage basic settings and features of the system, see the Dell EMC PowerEdge R640 BIOS and UEFI Reference Guide on the product documentation page.

## iDRAC configuration

The Integrated Dell Remote Access Controller (iDRAC) is designed to make system administrators more productive and improve the overall availability of Dell systems. iDRAC alerts administrators about system issues and enables them to perform remote system management. This reduces the need for physical access to the system.

## Options to set up iDRAC IP address

To enable communication between your system and iDRAC, you must first configure the network settings based on your network infrastructure.

 **NOTE:** For static IP configuration, you must request for it at the time of purchase.

This option is set to **DHCP** by Default. You can set up the IP address by using one of the following interfaces:

Interfaces	Document/Section
<b>iDRAC Settings utility</b>	<i>Dell Integrated Dell Remote Access Controller User's Guide</i> at <a href="http://www.dell.com/poweredgemanuals">www.dell.com/poweredgemanuals</a>
<b>Dell Deployment Toolkit</b>	<i>Dell Deployment Toolkit User's Guide</i> at <a href="http://www.dell.com/openmanagemanuals">www.dell.com/openmanagemanuals</a> > OpenManage Deployment Toolkit
<b>Dell Lifecycle Controller</b>	<i>Dell Lifecycle Controller User's Guide</i> at <a href="http://www.dell.com/poweredgemanuals">www.dell.com/poweredgemanuals</a>
<b>Server LCD panel</b>	<a href="#">LCD panel</a> section

## Interfaces Document/Section

**iDRAC Direct and Quick Sync 2 (optional)** See *Dell Integrated Dell Remote Access Controller User's Guide* at [www.dell.com/poweredge manuals](http://www.dell.com/poweredge manuals)

**NOTE:** To access iDRAC, ensure that you connect the ethernet cable to the iDRAC9 dedicated network port. You can also access iDRAC through the shared LOM mode, if you have opted for a system that has the shared LOM mode enabled.

## Log in to iDRAC

You can log in to iDRAC as:

- iDRAC user
- Microsoft Active Directory user
- Lightweight Directory Access Protocol (LDAP) user

If you have opted for secure default access to iDRAC, you must use the iDRAC secure default password available on the system Information tag. If you have not opted for secure default access to iDRAC, then use the default user name and password `-root` and `calvin`. You can also log in by using your Single Sign-On or Smart Card.

**NOTE:** You must have the iDRAC credentials to log in to iDRAC.

**NOTE:** Ensure that you change the default username and password after setting up the iDRAC IP address.

For more information about logging in to the iDRAC and iDRAC licenses, see the latest *Integrated Dell Remote Access Controller User's Guide* at [www.dell.com/poweredge manuals](http://www.dell.com/poweredge manuals).

You can also access iDRAC by using RACADM. For more information, see the *RACADM Command Line Interface Reference Guide* at [www.dell.com/poweredge manuals](http://www.dell.com/poweredge manuals).

## Options to install the operating system

If the system is shipped without an operating system, install a supported operating system by using one of the following resources:

**Table 19. Resources to install the operating system**

Resources	Location
iDRAC	<a href="http://www.dell.com/idrac manuals">www.dell.com/idrac manuals</a>
Lifecycle Controller	<a href="http://www.dell.com/idrac manuals">www.dell.com/idrac manuals</a> > Lifecycle Controller
OpenManage Deployment Toolkit	<a href="http://www.dell.com/openmanage manuals">www.dell.com/openmanage manuals</a> > OpenManage Deployment Toolkit
Dell certified VMware ESXi	<a href="http://www.dell.com/virtualizationsolutions">www.dell.com/virtualizationsolutions</a>
Installation and How-to videos for supported operating systems on PowerEdge systems	<a href="#">Supported Operating Systems for Dell EMC PowerEdge systems</a>

## Methods to download firmware and drivers

You can download the firmware and drivers by using any of the following methods:

**Table 20. Firmware and drivers**

Methods	Location
From the Dell EMC support site	<a href="http://www.dell.com/support/home">www.dell.com/support/home</a>
Using Dell Remote Access Controller Lifecycle Controller (iDRAC with LC)	<a href="http://www.dell.com/idrac manuals">www.dell.com/idrac manuals</a>



**Table 20. Firmware and drivers (continued)**

<b>Methods</b>	<b>Location</b>
Using Dell Repository Manager (DRM)	<a href="http://www.dell.com/openmanagemanuals">www.dell.com/openmanagemanuals</a> > Repository Manager
Using Dell OpenManage Essentials	<a href="http://www.dell.com/openmanagemanuals">www.dell.com/openmanagemanuals</a> > OpenManage Essentials
Using Dell OpenManage Enterprise	<a href="http://www.dell.com/openmanagemanuals">www.dell.com/openmanagemanuals</a> > OpenManage Enterprise
Using Dell Server Update Utility (SUU)	<a href="http://www.dell.com/openmanagemanuals">www.dell.com/openmanagemanuals</a> > Server Update Utility
Using Dell OpenManage Deployment Toolkit (DTK)	<a href="http://www.dell.com/openmanagemanuals">www.dell.com/openmanagemanuals</a> > OpenManage Deployment Toolkit
Using iDRAC virtual media	<a href="http://www.dell.com/idracmanuals">www.dell.com/idracmanuals</a>

## Downloading drivers and firmware

Dell EMC recommends that you download and install the latest BIOS, drivers, and systems management firmware on your system.

### Prerequisites

Ensure that you clear the web browser cache before downloading the drivers and firmware.

### Steps

1. Go to [www.dell.com/support/home](http://www.dell.com/support/home).
2. In the **Drivers & Downloads** section, type the Service Tag of your system in the **Enter a Service Tag or product ID** box, and then click **Submit**.  
 **NOTE:** If you do not have the Service Tag, select **Detect Product** to allow the system to automatically detect the Service Tag, or click **View products**, and navigate to your product.
3. Click **Drivers & Downloads**.  
The drivers that are applicable to your system are displayed.
4. Download the drivers to a USB drive, CD, or DVD.

# Installing and removing system components

## Topics:

- Safety instructions
- Before working inside your system
- After working inside your system
- Recommended tools
- Optional front bezel
- System cover
- Drives
- Backplane cover
- Inside the system
- Air shroud
- Cooling fans
- System memory
- NVDIMM-N battery
- Processors and heat sinks
- Expansion cards and expansion card risers
- M.2 SSD module
- Optional IDSDM or vFlash module
- Optional IDSDM or vFlash module
- Network daughter card
- Integrated storage controller card
- Backplane
- Cable routing
- SAS expander card
- Rear drive cage
- System battery
- USB module
- VGA module
- Optional internal USB memory key
- Optical drive (optional)
- Power supply units
- System board
- Trusted Platform Module
- Control panel

## Safety instructions

 **NOTE:** Whenever you need to lift the system, get others to assist you. To avoid injury, do not attempt to lift the system by yourself.

 **WARNING:** Opening or removing the system cover while the system is powered on may expose you to a risk of electric shock.

 **CAUTION:** Do not operate the system without the cover for a duration exceeding five minutes. Operating the system without the system cover can result in component damage.

 **CAUTION:** Many repairs may only be done by a certified service technician. You should only perform troubleshooting and simple repairs as authorized in your product documentation, or as directed by the online or

telephone service and support team. Damage due to servicing that is not authorized by Dell is not covered by your warranty. Read and follow the safety instructions that are shipped with your product.

**NOTE:** It is recommended that you always use an antistatic mat and antistatic strap while working on components inside the system.

**CAUTION:** To ensure proper operation and cooling, all bays in the system and system fans must be always populated with a component or a blank.

## Before working inside your system

### Prerequisites

Follow the safety guidelines listed in [Safety instructions](#) on page 34.

### Steps

1. Turn off the system, including all attached peripherals.
2. Disconnect the system from the electrical outlet and disconnect the peripherals.
3. If applicable, remove the system from the rack.  
For more information, see the *Rack Installation Guide* at <https://www.dell.com/poweredgemanuals>.
4. Remove the system cover.

## After working inside your system

### Prerequisites

Follow the safety guidelines listed in [Safety instructions](#) on page 34.

### Steps

1. Reconnect the peripherals and connect the system to the electrical outlet.
2. Turn on the attached peripherals and then turn on the system.

## Recommended tools

You need the following tools to perform the removal and installation procedures:

- Key to the bezel lock

The key is needed only if your system includes a bezel.

- Phillips #1 screwdriver
- Phillips #2 screwdriver
- 1/4 inch flat head screwdriver
- Torx #T30 screwdriver
- Wrist grounding strap

You need the following tools to assemble the cables for a DC power supply unit.

- AMP 90871-1 hand-crimping tool or equivalent
- Tyco Electronics 58433-3 or equivalent
- Wire-stripper pliers to remove insulation from size 10 AWG solid or stranded, insulated copper wire

**NOTE:** Use alpha wire part number 3080 or equivalent (65/30 stranding).

# Optional front bezel

## Removing the front bezel

The procedure to remove the front bezel with and without the LCD panel is the same.

### Prerequisites

Follow the safety guidelines listed in [Safety instructions](#) on page 34.

### Steps

1. Unlock the bezel by using the bezel key.
2. Press the release button, and pull the left end of the bezel.
3. Unhook the right end, and remove the bezel.

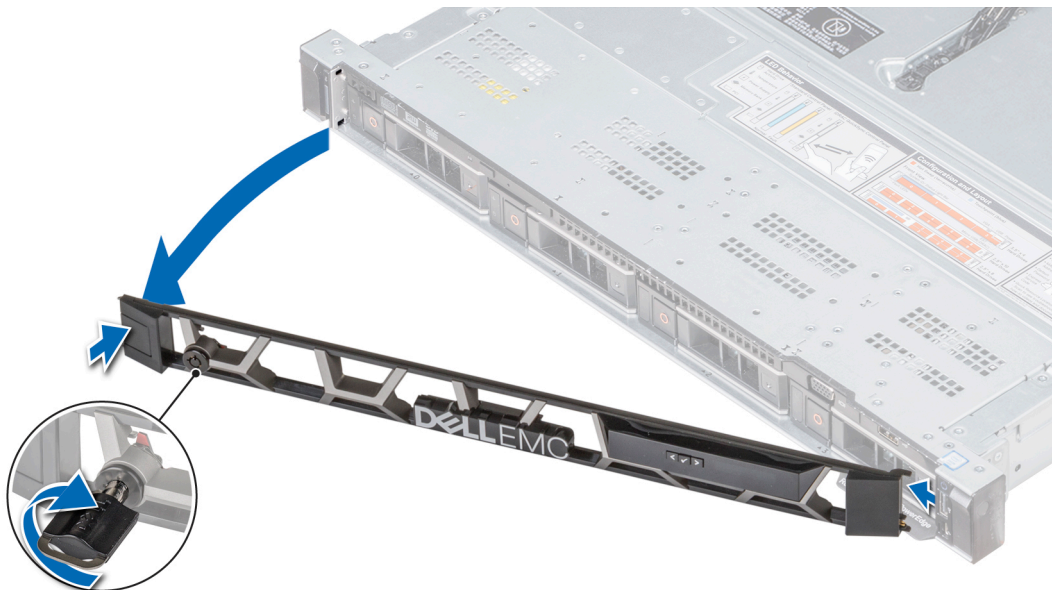

Figure 19. Removing the optional front bezel with the LCD panel

## Installing the front bezel

The procedure to install the front bezel with and without the LCD panel is the same.

### Prerequisites

Follow the safety guidelines listed in [Safety instructions](#) on page 34.

### Steps

1. Locate and remove the bezel key.  
**(i) NOTE:** The bezel key is part of the LCD bezel package.
2. Align and insert the right end of the bezel onto the system.
3. Press the bezel until the button clicks in place and fit the left end of the bezel onto the system.
4. Lock the bezel by using the key.

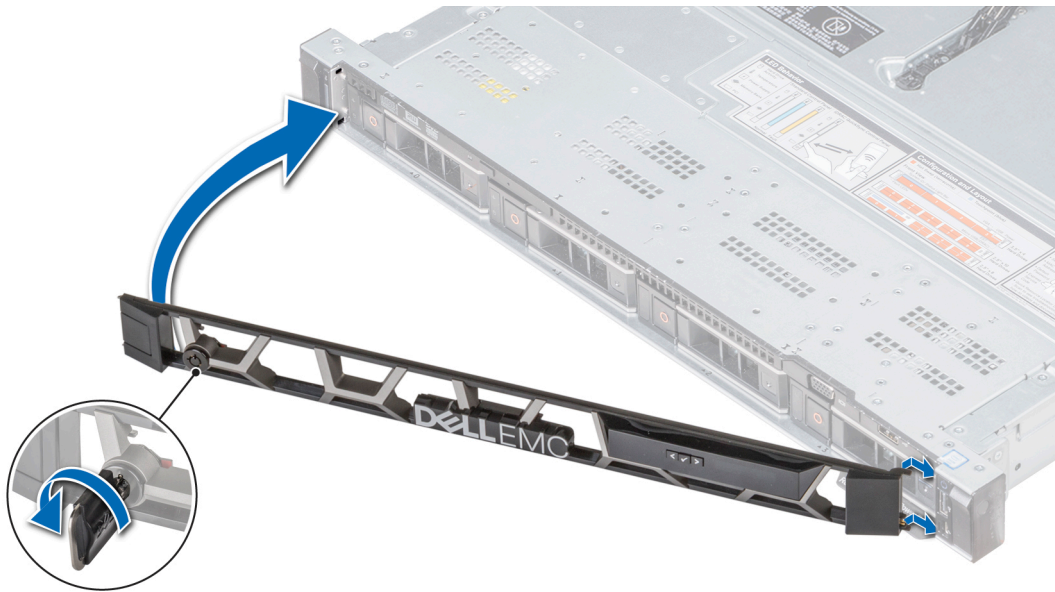

Figure 20. Installing the optional front bezel with the LCD panel

## System cover

### Removing the system cover

#### Prerequisites

1. Follow the safety guidelines listed in [Safety instructions](#) on page 34.
2. Turn off the system, including any attached peripherals.
3. Disconnect the system from the electrical outlet and disconnect the peripherals.

#### Steps

1. Using a 1/4 inch flat head or a Phillips #2 screwdriver, rotate the latch release lock counter clockwise to the unlocked position.
2. Lift the latch till the system cover slides back and the tabs on the system cover disengage from the guide slots on the system.
3. Hold the cover on both sides, and lift the cover away from the system.



**Figure 21. Removing the system cover**

## Installing the system cover

### Prerequisites

1. Follow the safety guidelines listed in [Safety instructions](#) on page 34.
2. Ensure that all internal cables are routed correctly and connected, and no tools or extra parts are left inside the system.

### Steps

1. Align the tabs on the system cover with the guide slots on the system.
2. Push the system cover latch down.  
The system cover slides forward, the tabs on the system cover engage with the guide slots on the system and the system cover latch locks into place.
3. Using a 1/4 inch flat head or Phillips #2 screwdriver, rotate the latch release lock clockwise to the locked position.



**Figure 22. Installing the system cover**

#### **Next steps**

1. Reconnect the peripherals and connect the system to the electrical outlet.
2. Turn on the system, including any attached peripherals.

## **Drives**

### **Removing a drive blank**

The procedure for removing 2.5 inch and 3.5 inch drive blanks is identical.

#### **Prerequisites**

1. Follow the safety guidelines listed in [Safety instructions](#) on page 34.
2. If installed, [remove the front bezel](#).

**⚠ CAUTION: To maintain proper system cooling, drive blanks must be installed in all empty drive slots.**

**⚠ CAUTION: Mixing drive blanks from previous generations of PowerEdge servers is not supported.**

#### **Steps**

Press the release button, and slide the drive blank out of the drive slot.

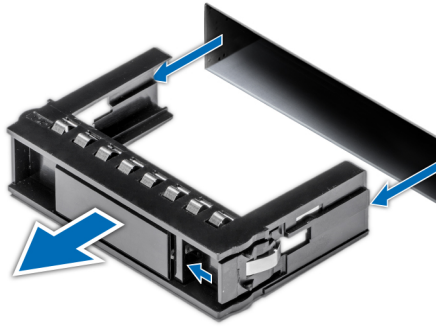

Figure 23. Removing a drive blank

#### Next steps

1. Install a drive or a drive blank.

## Installing a drive blank

#### Prerequisites

1. Follow the safety guidelines listed in [Safety instructions](#) on page 34.
2. If installed, [remove the front bezel](#).

**CAUTION:** Mixing drive blanks from previous generations of PowerEdge servers is not supported.

#### Steps

Insert the drive blank into the drive slot, and push the blank until the release button clicks into place.

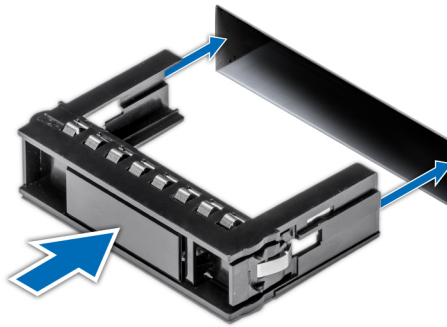

Figure 24. Installing a drive blank

#### Next steps

If removed, [install the front bezel](#).

## Removing a drive carrier

#### Prerequisites

1. Follow the safety guidelines listed in [Safety instructions](#) on page 34.
2. If applicable, [remove the front bezel](#).
3. Using the management software, prepare the drive for removal.



If the drive is online, the green activity or fault indicator flashes while the drive is turning off. When the drive indicators are off, the drive is ready for removal. For more information, see the documentation for the storage controller.

**CAUTION:** Before attempting to remove or install a drive while the system is running, see the documentation for the storage controller card to ensure that the host adapter is configured correctly to support drive removal and insertion.

**CAUTION:** Mixing drives from previous generations of PowerEdge servers is not supported.

**CAUTION:** To prevent data loss, ensure that your operating system supports drive installation. See the documentation supplied with your operating system.

### Steps

1. Press the release button to open the drive carrier release handle.
2. Holding the handle, slide the drive carrier out of the drive slot.



Figure 25. Removing a drive carrier

### Next steps

1. Follow the procedure listed in [After working inside your system](#) on page 35.
2. [Install a drive carrier](#).
3. If you are not replacing the drive immediately, insert a drive blank in the empty drive slot to maintain proper system cooling.

## Installing a drive carrier

### Prerequisites

**CAUTION:** Before attempting to remove or install a drive while the system is running, see the documentation for the storage controller card to ensure that the host adapter is configured correctly to support drive removal and insertion.

**CAUTION:** Mixing drives from previous generations of PowerEdge servers is not supported.

**CAUTION:** Combining SAS and SATA drives in the same RAID volume is not supported.

**CAUTION:** When installing a drive, ensure that the adjacent drives are fully installed. Inserting a drive carrier and attempting to lock its handle next to a partially installed carrier can damage the partially installed carrier's shield spring and make it unusable.

**CAUTION:** To prevent data loss, ensure that your operating system supports hot-swap drive installation. See the documentation supplied with your operating system.

**CAUTION:** When a replacement hot swappable drive is installed and the system is powered on, the drive automatically begins to rebuild. Ensure that the replacement drive is blank or contains data that you wish to overwrite. Any data on the replacement drive is immediately lost after the drive is installed.

1. Follow the safety guidelines listed in [Safety instructions](#) on page 34.
2. If applicable, [remove the drive blank](#).

### Steps

1. Press the release button on the front of the drive carrier to open the release handle.
2. Insert the drive carrier into the drive slot and slide until the drive connects with the backplane.
3. Close the drive carrier release handle to lock the drive in place.



**Figure 26. Installing a drive carrier**

### Next steps

If applicable, [install the front bezel](#).

## Removing the drive from the drive carrier

### Prerequisites

Follow the safety guidelines listed in [Safety instructions](#) on page 34.

**CAUTION:** Mixing drives from previous generations of PowerEdge servers is not supported.

### Steps

1. Using a Phillips #1 screwdriver, remove the screws from the slide rails on the drive carrier.
  - NOTE:** If the hard drive or SSD carrier has Torx screw, use Torx 6 (for 2.5-inch drive) or Torx 8 (for 3.5-inch drive) screwdriver to remove the drive.



2. Lift the drive out of the drive carrier.



Figure 27. Removing the drive from the drive carrier

### Next steps

If applicable, [install the drive into the drive carrier](#).

## Installing a drive into the drive carrier

### Prerequisites

Follow the safety guidelines listed in [Safety instructions](#) on page 34.

**CAUTION:** Mixing drive carriers from other generations of PowerEdge servers is not supported.

**NOTE:** When installing a drive into the drive carrier, ensure that the screws are torqued to 4 in-lbs.

### Steps

1. Insert the drive into the drive carrier with the connector end of the drive towards the back of the carrier.
2. Align the screw holes on the drive with the screws holes on the drive carrier.  
When aligned correctly, the back of the drive is flush with the back of the drive carrier.
3. Using a Phillips #1 screwdriver, secure the drive to the drive carrier with screws.  
**NOTE:** If the hard drive or SSD carrier has Torx screw, use Torx 6 (for 2.5-inch drive) or Torx 8 (for 3.5-inch drive) screwdriver to install the drive.



Figure 28. Installing a drive into the drive carrier

## Backplane cover

### Removing the backplane cover

#### Prerequisites

1. Follow the safety guidelines listed in [Safety instructions](#) on page 34.
2. Follow the procedure listed in [Before working inside your system](#) on page 35.
3. [Remove the system cover.](#)

#### Steps

1. Slide the backplane cover in the direction of the arrows marked on the backplane cover.
2. Lift the backplane cover away from the system.

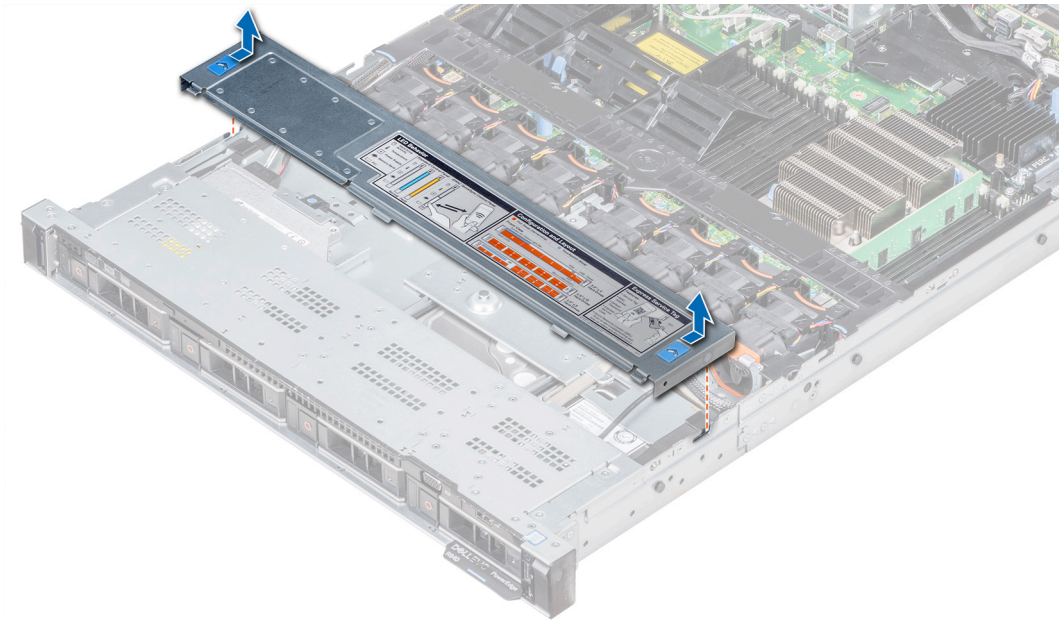

**Figure 29. Removing the backplane cover**

## Installing the backplane cover

### Prerequisites

1. Follow the safety guidelines listed in [Safety instructions](#) on page 34.
2. Follow the procedure listed in [Before working inside your system](#) on page 35.
3. [Install the system cover](#).

### Steps

1. Align the tabs on the backplane cover with the guide slots on the system.
2. Slide the backplane cover toward the front of the system until the cover locks into place.

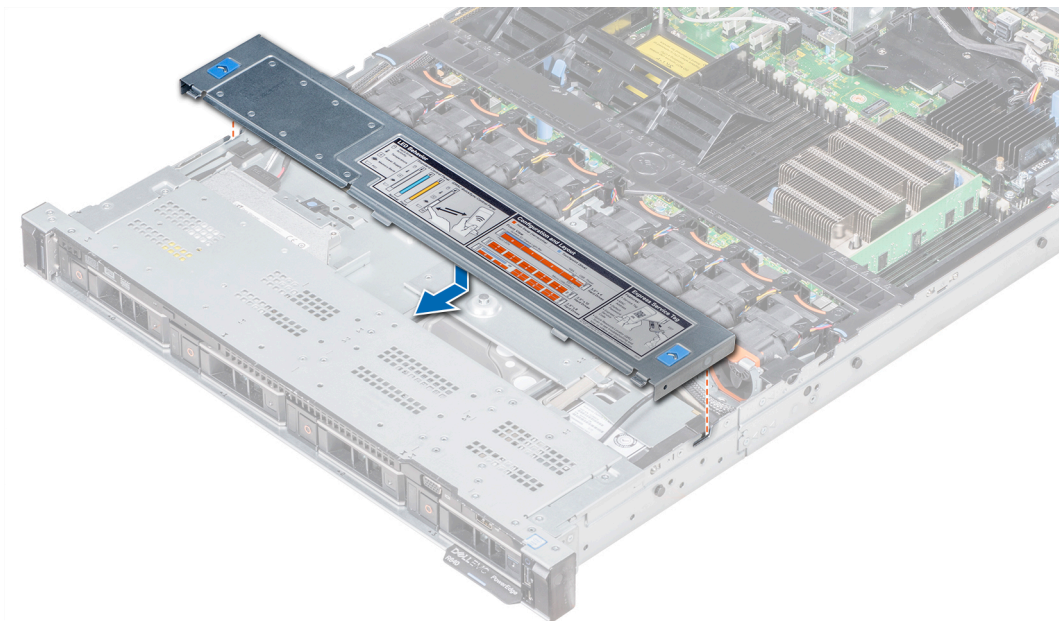

**Figure 30. Installing the backplane cover**

## Next steps

Follow the procedure listed in [After working inside your system](#) on page 35.

# Inside the system

**CAUTION:** Many repairs may only be done by a certified service technician. You should only perform troubleshooting and simple repairs as authorized in your product documentation, or as directed by the online or telephone service and support team. Damage due to servicing that is not authorized by Dell is not covered by your warranty. Read and follow the safety instructions that are shipped with your product.

**NOTE:** Components that are hot swappable are marked orange and touch points on the components are marked blue.

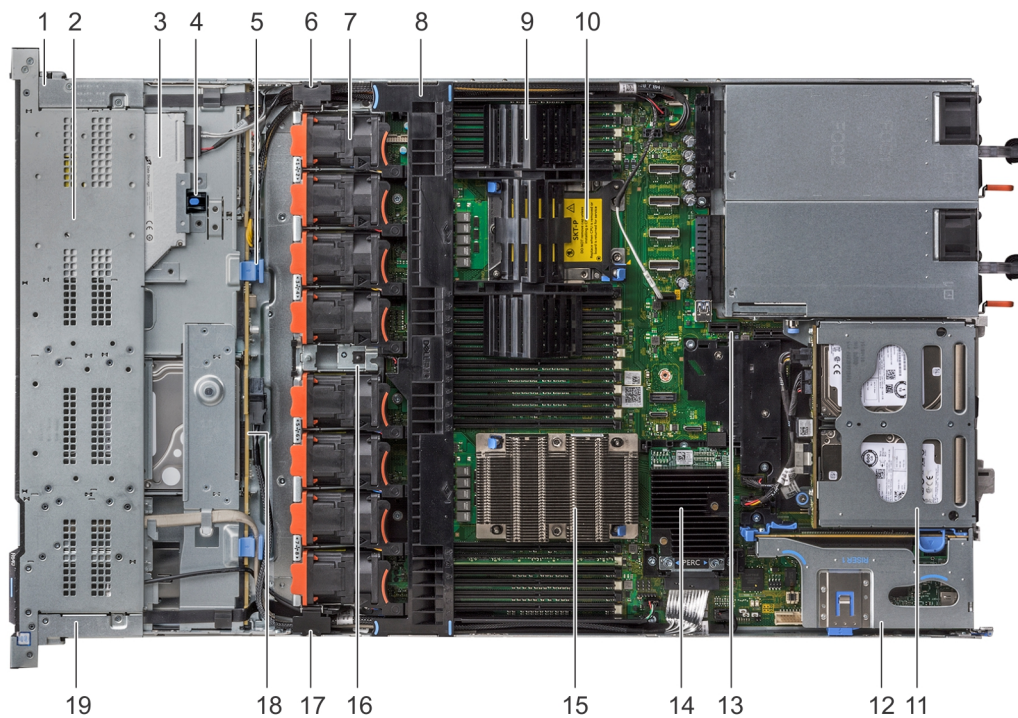

**Figure 31. Inside the system - 1 PCIe expansion riser**

- |                                    |  |
|------------------------------------|--|
| 1. right control panel cable cover | 2. hard drive cage                     |
| 3. optical drive                   | 4. optical drive release latch         |
| 5. backplane release latch         | 6. cabling latch                       |
| 7. cooling fan (8)                 | 8. air shroud                          |
| 9. processor and DIMM blank        | 10. processor 2 slot                   |
| 11. rear hard drive module         | 12. expansion riser 1                  |
| 13. IDSDM/vFlash module slot       | 14. integrated storage controller card |
| 15. processor 1                    | 16. intrusion switch                   |
| 17. cabling latch                  | 18. hard drive backplane               |
| 19. left control panel cable cover |  |

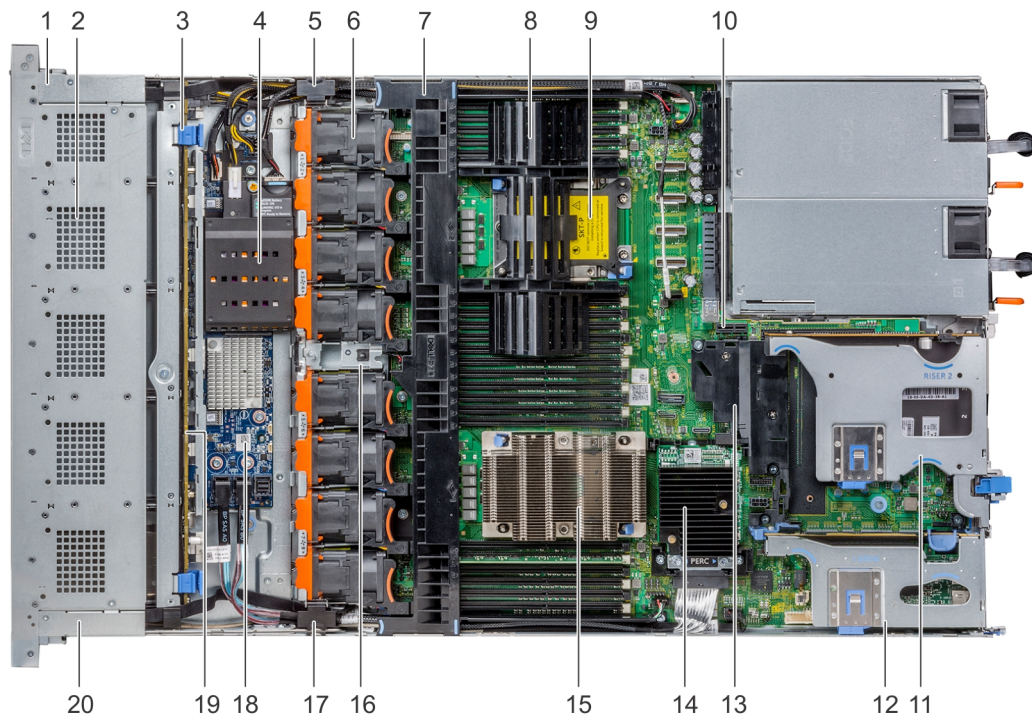

**Figure 32. Inside the system - 2 PCIe expansion risers**

- |                                    |  |
|------------------------------------|--|
| 1. right control panel cable cover | 2. hard drive cage                     |
| 3. backplane release latch         | 4. NVDIMM-N battery                    |
| 5. cabling latch                   | 6. cooling fan (8)                     |
| 7. air shroud                      | 8. processor and DIMM blank            |
| 9. processor 2 slot                | 10. IDSDM/vFlash module slot           |
| 11. expansion riser 2 B            | 12. expansion riser 1 B                |
| 13. PCIe shroud                    | 14. integrated storage controller card |
| 15. processor 1                    | 16. intrusion switch                   |
| 17. cabling latch                  | 18. SAS expander board                 |
| 19. hard drive backplane           | 20. left control panel cable cover     |

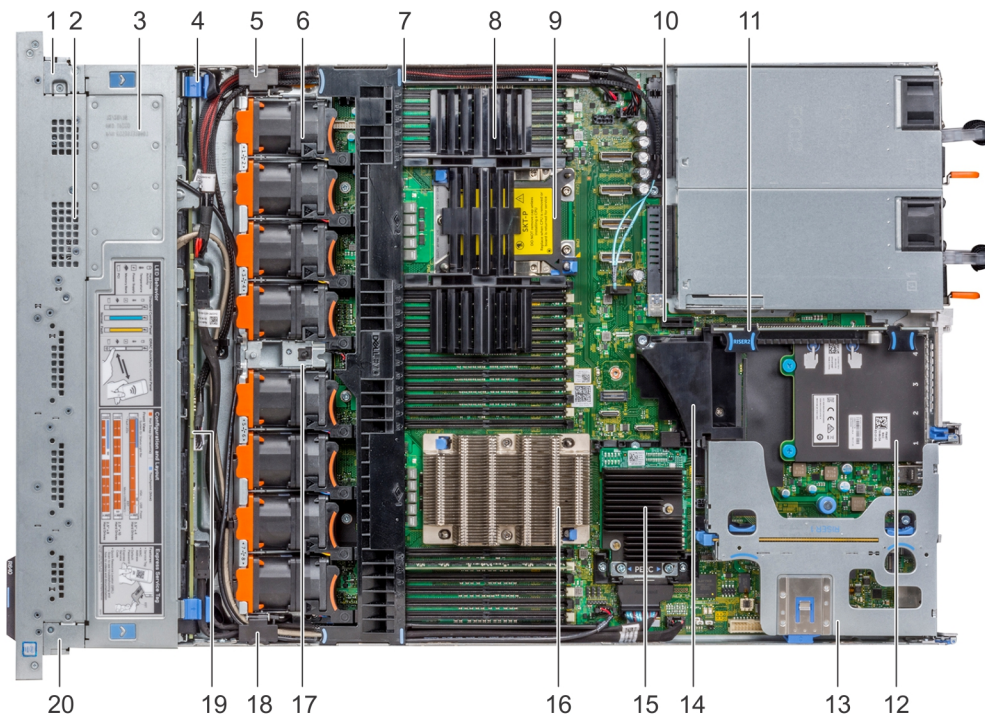

**Figure 33. Inside the system - 3 PCIe expansion risers**

- |  |                                    |
|--|------------------------------------|
| 1. right control panel cable cover     | 2. hard drive cage                 |
| 3. backplane cover                     | 4. backplane release latch         |
| 5. cabling latch                       | 6. cooling fan (8)                 |
| 7. air shroud                          | 8. processor and DIMM blank        |
| 9. processor 2 slot                    | 10. IDSDM/vFlash module slot       |
| 11. expansion riser 2 A                | 12. network daughter card          |
| 13. expansion riser 1 A                | 14. PCIe shroud                    |
| 15. integrated storage controller card | 16. processor 1                    |
| 17. intrusion switch                   | 18. cabling latch                  |
| 19. hard drive backplane               | 20. left control panel cable cover |



# Air shroud

## Removing the air shroud

### Prerequisites

**CAUTION:** Never operate your system with the air shroud removed. The system may get overheated quickly, resulting in shutdown of the system and loss of data.

1. Follow the safety guidelines listed in [Safety instructions](#) on page 34.
2. Follow the procedure listed in [Before working inside your system](#) on page 35.

### Steps

Hold the air shroud at both ends and lift it away from the system.

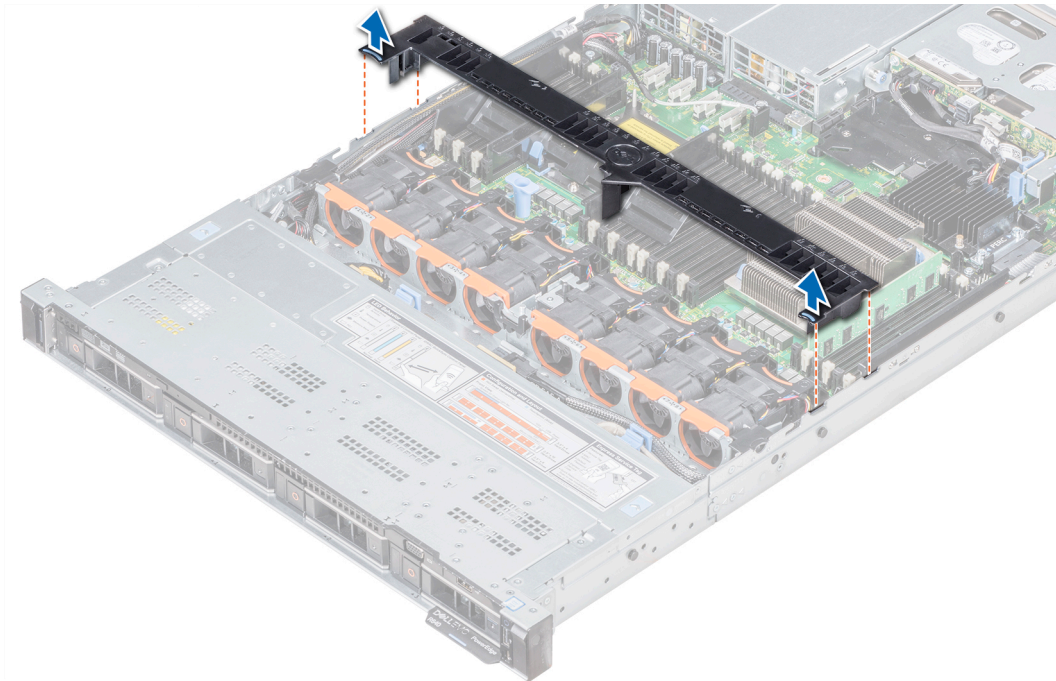

Figure 34. Removing the air shroud

### Next steps

1. If applicable, [install the air shroud](#).
2. Follow the procedure listed in [After working inside your system](#) on page 35.

## Installing the air shroud

### Prerequisites

1. Follow the safety guidelines listed in [Safety instructions](#) on page 34.
2. Follow the procedure listed in [Before working inside your system](#) on page 35.
3. If applicable, route the cables inside the system along the system wall and secure the cables by using the cable latch.

### Steps

1. Align the tabs on the air shroud with the slots on the system.
2. Lower the air shroud into the system until it is firmly seated.

When firmly seated, the memory socket numbers marked on the air shroud align with the respective memory sockets.

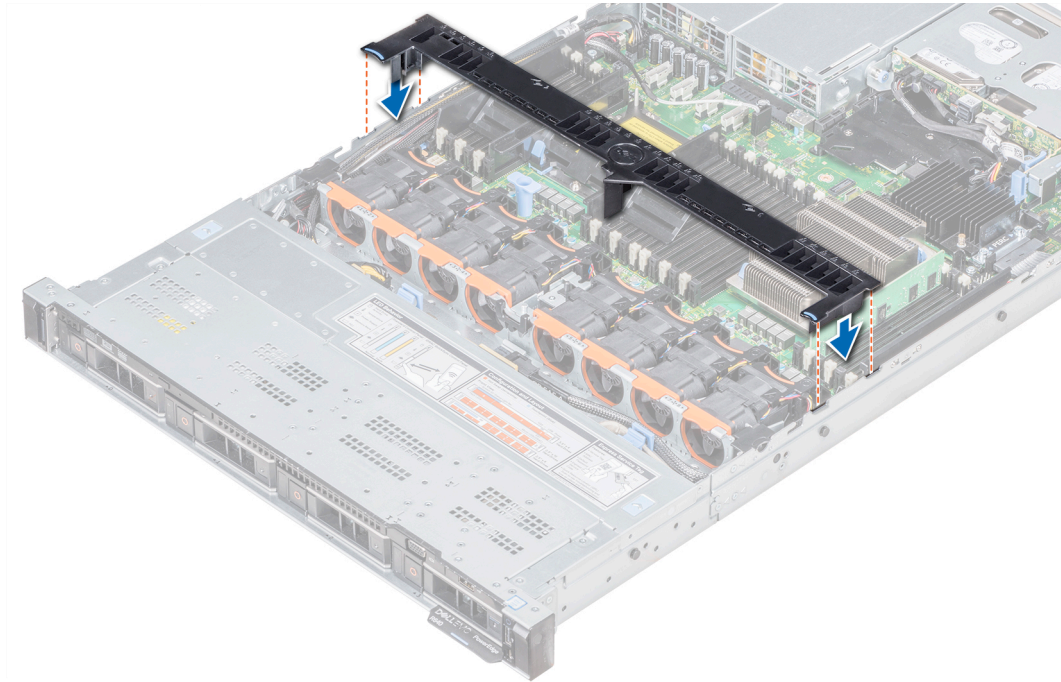

**Figure 35. Installing the air shroud**

#### Next steps

1. Follow the procedure listed in [After working inside your system](#) on page 35.

## Cooling fans

### Removing a cooling fan

The procedure for removing standard and high performance fans is identical.

#### Prerequisites

**NOTE:** Opening or removing the system cover when the system is on may expose you to a risk of electric shock. Exercise utmost care while removing or installing cooling fans.

**CAUTION:** The cooling fans are hot swappable. To maintain proper cooling while the system is on, replace only one fan at a time.

1. Follow the safety guidelines listed in [Safety instructions](#) on page 34.
2. [Remove the air shroud.](#)

#### Steps

1. Holding the touch points on the cooling fan, lift the fan to disconnect the connector on the fan from the connector on the system board.
2. Lift the fan out of the system.

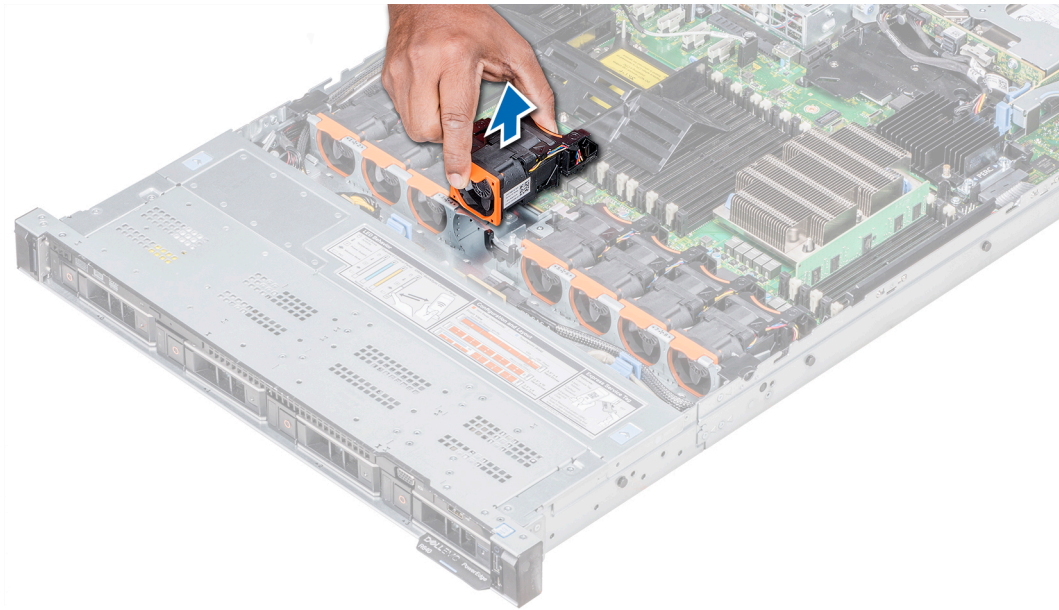

**Figure 36. Removing the cooling fan**

### Next steps

If applicable, [install the cooling fan](#).

## Installing a cooling fan

The procedure for installing standard and high performance fans is identical.

### Prerequisites

**i NOTE:** Opening or removing the system cover when the system is on may expose you to a risk of electric shock. Exercise utmost care while removing or installing cooling fans.

**⚠ CAUTION:** The cooling fans are hot swappable. To maintain proper cooling while the system is on, replace only one fan at a time.

Follow the safety guidelines listed in [Safety instructions](#) on page 34.

### Steps

1. Holding the touch points on the cooling fan, align the connector on the cooling fan with the connector on the system board.
2. Push the cooling fan, by pressing on the touch point, till the fan is firmly seated on the connector.

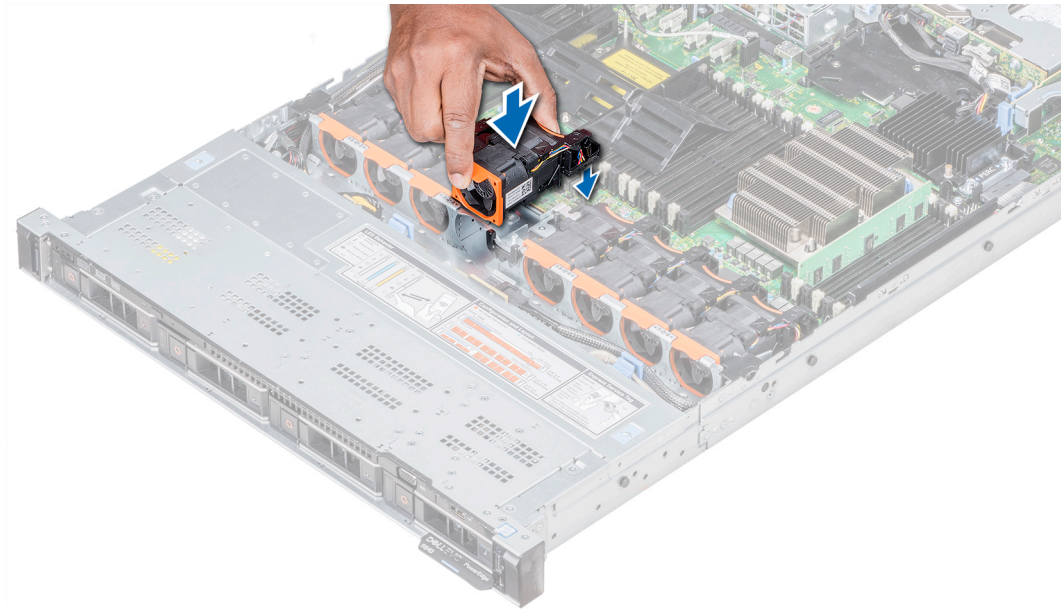

**Figure 37. Installing the cooling fan**

#### **Next steps**

1. [Install the air shroud.](#)
2. Follow the procedure listed in [After working inside your system](#) on page 35.

## **System memory**

### **System memory guidelines**

The PowerEdge systems support DDR4 Registered DIMMs (RDIMMs), Load Reduced DIMMs (LRDIMMs), Non-Volatile DIMMs (NVDIMM-Ns), and Intel Optane Persistent memory (PMem). System memory holds the instructions that are executed by the processor.

Your system contains 24 memory sockets split into two sets of 12 sockets, one set per processor. Each 12-socket set is organized into six channels. Six memory channels are allocated to each processor. In each channel, the release tabs of the first socket are marked white, and the second socket black.

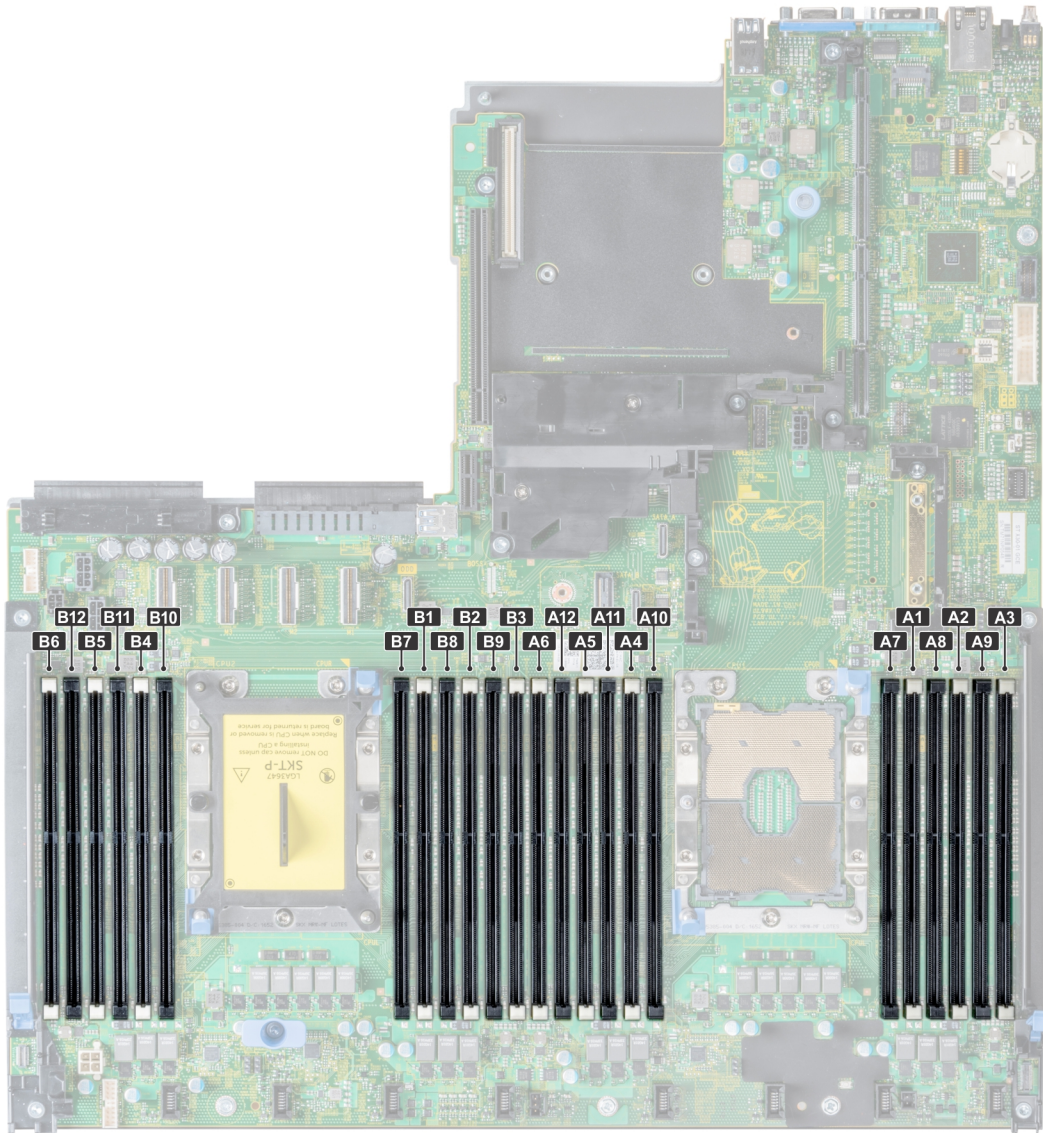

**Figure 38. System memory view**

Memory channels are organized as follows:

**Table 21. Memory channels**

Processor	Channel 0	Channel 1	Channel 2	Channel 3	Channel 4	Channel 5
Processor 1	Slots A1 and A7	Slots A2 and A8	Slots A3 and A9	Slots A4 and A10	Slots A5 and A11	Slots A6 and A12
Processor 2	Slots B1 and B7	Slots B2 and B8	Slots B3 and B9	Slots B4 and B10	Slots B5 and B11	Slots B6 and B12

## General memory module installation guidelines

To ensure optimal performance of your system, observe the following general guidelines when configuring your system memory. If your system's memory configurations fail to observe these guidelines, your system might not boot, stop responding during memory configuration, or operate with reduced memory.

The memory bus may operate at frequencies 2933 MT/s, 2666 MT/s, 2400 MT/s, or 2133 MT/s depending on the following factors:

- System profile selected (for example, Performance Optimized, or Custom [can be run at high speed or lower])
- Maximum supported DIMM speed of the processors. For memory frequency of 2933 MT/s, one DIMM per channel is supported.
- Maximum supported DIMM speed of the processors.
- Maximum supported speed of the DIMMs

**i** **NOTE:** MT/s indicates DIMM speed in MegaTransfers per second.

The system supports Flexible Memory Configuration, enabling the system to be configured and run in any valid chipset architectural configuration. The following are the recommended guidelines for installing memory modules:

- All DIMMs must be DDR4.
- RDIMMs and LRDIMMs must not be mixed.
- NVDIMMs and LRDIMMs must not be mixed.
- NVDIMMs and RDIMMs can be mixed.
- 64 GB LRDIMMs that are DDP (Dual Die Package) LRDIMMs must not be mixed with 128 GB LRDIMMs that are TSV (Through Silicon Via/3DS) LRDIMMs.
- x4 and x8 DRAM based memory modules can be mixed.
- Up to two RDIMMs can be populated per channel regardless of rank count.
- Up to two LRDIMMs can be populated per channel regardless of rank count.
- A maximum of two different ranked DIMMs can be populated in a channel regardless of rank count.
- If memory modules with different speeds are installed, they will operate at the speed of the slowest installed memory module(s).
- Populate memory module sockets only if a processor is installed.
  - For single-processor systems, sockets A1 to A12 are available.
  - For dual-processor systems, sockets A1 to A12 and sockets B1 to B12 are available.
- Populate all the sockets with white release tabs first, followed by the black release tabs.
- When mixing memory modules with different capacities, populate the sockets with memory modules with the highest capacity first.

**i** **NOTE:** For example, if you want to mix 8 GB and 16 GB memory modules, populate 16 GB memory modules in the sockets with white release tabs and 8 GB memory modules in the sockets with black release tabs.

- Memory modules of different capacities can be mixed provided other memory population rules are followed.

**i** **NOTE:** For example, 8 GB and 16 GB memory modules can be mixed.

- In a dual-processor configuration, the memory configuration for each processor must be identical.

**i** **NOTE:** For example, if you populate socket A1 for processor 1, then populate socket B1 for processor 2, and so on.

- Mixing of more than two memory module capacities in one system is not supported.
- Unbalanced memory configurations will result in a performance loss so always populate memory channels identically with identical DIMMs for best performance.
- Populate six identical memory modules per processor (one DIMM per channel) at a time to maximize performance.

DIMM population update for Performance Optimized mode with quantity of 4 and 8 DIMMs per processor.

- When the DIMM quantity is 4 per processor, the population is slot 1, 2, 4, 5.
- When the DIMM quantity is 8 per processor, the population is slot 1, 2, 4, 5, 7, 8, 10, 11.

## NVDIMM-N memory module installation guidelines

The following are the recommended guidelines for installing NVDIMM-N memory modules:

- Each system supports memory configurations with 1, 2, 4, 6, or 12 NVDIMM-Ns.
- Supported configurations have dual processors and a minimum of 12x RDIMMs.
- Maximum of 12 NVDIMM-Ns can be installed in a system.
- NVDIMM-Ns or RDIMMs must not be mixed with LRDIMMs.
- DDR4 NVDIMM-Ns must be populated only on the black release tabs on processor 1 and 2.
- For systems with four processors, RDIMMs populated on processor 3 and 4 must be identical to the number of RDIMMs populated on processor 1 and 2.
- All slots on configurations 3, 6, 9, and 12 can be used, but a maximum of 12 NVDIMM-Ns can be installed in a system.

**i** **NOTE:** NVDIMM-N memory slots are not hot-pluggable.

For more information about the supported NVDIMM-N configurations, see the *NVDIMM-N User Guide* at [www.dell.com/poweredgemanuals](http://www.dell.com/poweredgemanuals).

**Table 22. Supported NVDIMM-N for dual processor configurations**

Configuration	Description	Memory population rules	
		RDIMMs	NVDIMM-N
Configuration 1	12x 16 GB RDIMMs, 1x NVDIMM-N	Processor1 {A1, 2, 3, 4, 5, 6} Processor2 {B1, 2, 3, 4, 5, 6}	Processor1 {A7}
Configuration 2	12x 32 GB RDIMMs, 1x NVDIMM-N	Same for all 12x RDIMM configurations. See Configuration 1.	Processor1 {A7}
Configuration 3	23x 32 GB RDIMMs, 1x NVDIMM-N	Processor1 {A1, 2, 3, 4, 5, 6, 7, 8, 9, 10, 11, 12} Processor2 {B1, 2, 3, 4, 5, 6, 7, 8, 9, 10, 11}	Processor2 {B12}
Configuration 4	12x 16 GB RDIMMs, 2x NVDIMM-Ns	Same for all 12x RDIMM configurations. See Configuration 1.	Processor1 {A7} Processor2 {B7}
Configuration 5	12x 32 GB RDIMMs, 2x NVDIMM-Ns	Same for all 12x RDIMM configurations. See Configuration 1.	Processor1 {A7} Processor2 {B7}
Configuration 6	22x 32 GB RDIMMs, 2x NVDIMM-Ns	Processor1 {A1, 2, 3, 4, 5, 6, 7, 8, 9, 10, 11} Processor2 {B1, 2, 3, 4, 5, 6, 7, 8, 9, 10, 11}	Processor1 {A12} Processor2 {B12}
Configuration 7	12x 16 GB RDIMMs, 4x NVDIMM-Ns	Same for all 12x RDIMM configurations. See Configuration 1.	Processor1 {A7, A8} Processor2 {B7, B8}
Configuration 8	22x 32 GB RDIMMs, 4x NVDIMM-Ns	Same for all 12x RDIMM configurations. See Configuration 1.	Processor1 {A7, A8} Processor2 {B7, B8}
Configuration 9	20x 32 GB RDIMMs, 4x NVDIMM-Ns	Processor1 {A1, 2, 3, 4, 5, 6, 7, 8, 9, 10} Processor2 {B1, 2, 3, 4, 5, 6, 7, 8, 9, 10}	Processor1 {A11, 12} Processor2 {B11, 12}
Configuration 10	12x 16 GB RDIMMs, 6x NVDIMM-Ns	Same for all 12x RDIMM configurations. See Configuration 1.	Processor1 {A7, 8, 9} Processor2 {B7, 8, 9}
Configuration 11	12x 32 GB RDIMMs, 6x NVDIMM-Ns	Same for all 12x RDIMM configurations. See Configuration 1.	Processor1 {A7, 8, 9} Processor2 {B7, 8, 9}
Configuration 12	18x 32 GB RDIMMs, 6x NVDIMM-Ns	Processor1 {1, 2, 3, 4, 5, 6, 7, 8, 9} Processor2 {1, 2, 3, 4, 5, 6, 7, 8, 9}	Processor1 {A10, 11, 12} Processor2 {B10, 11, 12}

**Table 22. Supported NVDIMM-N for dual processor configurations (continued)**

Configuration	Description	Memory population rules	
		RDIMMs	NVDIMM-N
Configuration 13	12x 16 GB RDIMMs, 12x NVDIMM-Ns	Same for all 12x RDIMM configurations. See Configuration 1.	Processor1 {A7, 8, 9, 10, 11, 12} Processor2 {B7, 8, 9, 10, 11, 12}
Configuration 14	12x 32 GB RDIMMs, 12x NVDIMM-Ns	Same for all 12x RDIMM configurations. See Configuration 1.	Processor1 {A7, 8, 9, 10, 11, 12} Processor2 {B7, 8, 9, 10, 11, 12}

**Table 23. Supported NVDIMM-N for quad processor configurations**

Configuration	Description	Memory population rules	
		RDIMMs	NVDIMM-N
Configuration 1	24x 16 GB RDIMMs, 1x NVDIMM-N	Processor1 {A1, 2, 3, 4, 5, 6}, Processor2 {B1, 2, 3, 4, 5, 6}, Processor3 {C1, 2, 3, 4, 5, 6} Processor4 {D1, 2, 3, 4, 5, 6}	Processor1 {A7}
Configuration 2	24x 32 GB RDIMMs, 1x NVDIMM-N	Same for all 24x RDIMM configurations. See Configuration 1.	Processor1 {A7}
Configuration 3	47x 32 GB RDIMMs, 1x NVDIMM-N	Processor1 {A1, 2, 3, 4, 5, 6, 7, 8, 9, 10, 11, 12} , Processor2 {B1, 2, 3, 4, 5, 6, 7, 8, 9, 10, 11} , Processor3 {C1, 2, 3, 4, 5, 6, 7, 8, 9, 10, 11, 12} Processor 4 {D1, 2, 3, 4, 5, 6, 7, 8, 9, 10, 11, 12}	Processor2 {B12}
Configuration 4	24x 16 GB RDIMMs, 2x NVDIMM-Ns	Processor1 {A1, 2, 3, 4, 5, 6}, Processor2 {B1, 2, 3, 4, 5, 6} Processor3 {C1, 2, 3, 4, 5, 6} Processor4 {D1, 2, 3, 4, 5, 6}	Processor1 {A7}, Processor2 {B7}
Configuration 5	24x 32 GB RDIMMs, 2x NVDIMM-Ns	Processor1 {A1, 2, 3, 4, 5, 6}, Processor2 {B1, 2, 3, 4, 5, 6}, Processor3 {C1, 2, 3, 4, 5, 6} Processor4 {D1, 2, 3, 4, 5, 6}	Processor1 {A7}, Processor2 {B7}
Configuration 6	46x 32 GB RDIMMs, 2x NVDIMM-Ns	Processor1 {A1, 2, 3, 4, 5, 6, 7, 8, 9, 10, 11}, Processor2 {B1, 2, 3, 4, 5, 6, 7, 8, 9, 10, 11} , Processor3 {C1, 2, 3, 4, 5, 6, 7, 8, 9, 10, 11, 12} Processor 4 {D1, 2, 3, 4, 5, 6, 7, 8, 9, 10, 11, 12}	Processor1 {A12}, Processor2 {B12}
Configuration 7	24x 16 GB RDIMMs, 4x NVDIMM-Ns	Processor1 {A1, 2, 3, 4, 5, 6}, Processor2 {B1, 2, 3, 4, 5, 6},	Processor1 {A7,8}, Processor2 {B7,8}



**Table 23. Supported NVDIMM-N for quad processor configurations (continued)**

Configuration	Description	Memory population rules	
		RDIMMs	NVDIMM-N
		Processor3 {C1, 2, 3, 4, 5, 6} Processor4 {D1, 2, 3, 4, 5, 6}	
Configuration 8	24x 32 GB RDIMMs, 4x NVDIMMs	Processor1 {A1, 2, 3, 4, 5, 6}, Processor2 {B1, 2, 3, 4, 5, 6}, Processor3 {C1, 2, 3, 4, 5, 6} Processor4 {D1, 2, 3, 4, 5, 6}	Processor1 {A7,8}, Processor2 {B7,8}
Configuration 9	44x 32 GB RDIMMs, 4x NVDIMM-Ns	Processor1 {A1, 2, 3, 4, 5, 6, 7, 8, 9, 10}, Processor2 {B1, 2, 3, 4, 5, 6, 7, 8, 9, 10}, Processor3 {C1, 2, 3, 4, 5, 6, 7, 8, 9, 10, 11, 12} Processor4 {D1, 2, 3, 4, 5, 6, 7, 8, 9, 10, 11, 12}	Processor1 {A11, 12}, Processor2 {B11, 12}
Configuration 10	24x 16 GB RDIMMs, 6x NVDIMM-Ns	Processor1 {A1, 2, 3, 4, 5, 6}, Processor2 {B1, 2, 3, 4, 5, 6} Processor3 {C1, 2, 3, 4, 5, 6} Processor4 {D1, 2, 3, 4, 5, 6}	Processor1 {A7, 8, 9} Processor2 {B7, 8, 9}
Configuration 11	24x 32 GB RDIMMs, 6x NVDIMM-Ns	Processor1 {A1, 2, 3, 4, 5, 6}, Processor2 {B1, 2, 3, 4, 5, 6}, Processor3 {C1, 2, 3, 4, 5, 6} Processor4 {D1, 2, 3, 4, 5, 6}	Processor1 {A7, 8, 9} Processor2 {B7, 8, 9}
Configuration 12	42x 32 GB RDIMMs, 6x NVDIMM-Ns	Processor1 {A1, 2, 3, 4, 5, 6, 7, 8, 9}, Processor2 {B1, 2, 3, 4, 5, 6, 7, 8, 9} Processor3 {C1, 2, 3, 4, 5, 6, 7, 8, 9, 10, 11, 12} Processor4 {D1, 2, 3, 4, 5, 6, 7, 8, 9, 10, 11, 12}	Processor1 {A10,11,12} Processor2 {B10, 11, 12}
Configuration 13	24x 16 GB RDIMMs, 12x NVDIMM-Ns	Processor1 {A1, 2, 3, 4, 5, 6}, Processor2 {B1, 2, 3, 4, 5, 6}, Processor3 {C1, 2, 3, 4, 5, 6} Processor4 {D1, 2, 3, 4, 5, 6}	Processor1 {A7, 8, 9, 10, 11, 12}, Processor2 {B7, 8, 9, 10, 11, 12}
Configuration 14	24x 32 GB RDIMMs, 12x NVDIMM-Ns	Processor1 {A1, 2, 3, 4, 5, 6}, Processor2 {B1, 2, 3, 4, 5, 6}, Processor3 {C1, 2, 3, 4, 5, 6} Processor4 {D1, 2, 3, 4, 5, 6}	Processor1 {A7, 8, 9, 10, 11, 12}, Processor2 {B7, 8, 9, 10, 11, 12}
Configuration 15	36x 32 GB RDIMMs, 12x NVDIMM-Ns	Processor1 {A1, 2, 3, 4, 5, 6}, Processor2 {B1, 2, 3, 4, 5, 6}, Processor3 {C1, 2, 3, 4, 5, 6, 7, 8, 9, 10, 11, 12} Processor 4 {D1, 2, 3, 4, 5, 6, 7, 8, 9, 10, 11, 12}	Processor1 {A7, 8, 9, 10, 11, 12}, Processor2 {B7, 8, 9, 10, 11, 12}

## PMem installation guidelines

The following are the recommended guidelines for installing data center persistent memory module (PMem) memory modules:

- Each system supports maximum of one PMem memory module per channel.
- **NOTE:** If two different PMem capacities are mixed, an F1/F2 warning is displayed as the configuration is not supported.
- PMem can be mixed with RDIMM, LRDIMM, and 3DS LRDIMM.
- Mixing of DDR4 DIMM types (RDIMM, LRDIMM, and 3DS LRDIMM), within channels, for Integrated Memory Controller (iMC), or across sockets are not supported.
- Mixing of PMem operating modes (App Direct, Memory Mode) is not supported.
- If only one DIMM is populated on a channel, it should always go to the first slot in that channel (white slot).
- If a PMem and a DDR4 DIMM are populated on the same channel, always plug PMem on second slot (black slot).
- If the PMem is configured in Memory Mode, the recommended DDR4 to PMem capacity ratio is 1:4 to 1:16 per iMC.
- PMems' cannot be mixed with other PMems capacities or NVDIMMs.
- Mixing different capacities of RDIMMs and LRDIMMs are not allowed when PMem is installed.
- PMems of different capacities are not allowed.

For more information about the supported PMem configurations, see the *Dell EMC PMem User 's Guide* at [https://www.dell.com/support/home/products/server\\_int/server\\_int\\_poweredge](https://www.dell.com/support/home/products/server_int/server_int_poweredge).

**Table 24. 2 socket PMem configurations**

No. of CPUs in the Server	PMem Population	DRAM Population	DRAM Capacity (GB)	PMem Capacity (GB)	Operating system Memory in Memory Mode (GB)	Total Memory (GB)	Total Memory per CPU (GB)	Ratio DRAM to Optane Memory	Requires an M or L CPU	Supported in App Direct Mode	Supported in Memory Mode
2	128 GB x 1	16 GB x 12	192	128	N/A	320	160	1 : 0.7	No	Yes	No
2	128 GB x 2	16 GB x 12	192	256	N/A	448	224	1 : 1.3	No	Yes	No
2	128 GB x 4	16 GB x 8	128	512	512	640	320	1 : 4	No	Yes	Yes
2	128 GB x 4	16 GB x 12	192	512	N/A	704	352	1 : 2.7	No	Yes	No
2	128 GB x 8	16 GB x 12	192	1,024	1,024	1,216	608	1 : 5.3	No	Yes	Yes
2	128 GB x 12	16 GB x 12	192	1,536	1,536	1,728	864	1 : 8	No	Yes	Yes
2	128 GB x 1	32 GB x 12	384	128	N/A	512	256	1 : 0.3	No	Yes	No
2	128 GB x 2	32 GB x 12	384	256	N/A	640	320	1 : 0.7	No	Yes	No
2	128 GB x 4	32 GB x 12	384	512	N/A	896	448	1 : 1.3	No	Yes	No
2	128 GB x 8	32 GB x 12	384	1,024	N/A	1,408	704	1 : 2.7	No	Yes	No
2	128 GB x 12	32 GB x 12	384	1,536	1,536	1,920	960	1 : 4	No	Yes	Yes
2	128 GB x 4	64 GB x 12	768	512	N/A	1,280	640	1 : 0.7	No	Yes	No
2	128 GB x 8	64 GB x 12	768	1,024	N/A	1,792	896	1 : 1.3	No	Yes	No

**Table 24. 2 socket PMem configurations (continued)**

No. of CPUs in the Server	PMem Population	DRAM Population	DRAM Capacity (GB)	PMem Capacity (GB)	Operating system Memory in Memory Mode (GB)	Total Memory (GB)	Total Memory per CPU (GB)	Ratio DRAM to Optane Memory	Requires an M or L CPU	Supported in App Direct Mode	Supported in Memory Mode
2	128 GB x 12	64 GB x 12	768	1,536	N/A	2,304	1,152	1 : 2	L SKU	Yes	No
2	128 GB x 12	128 GB x 12	1,536	1,536	N/A	3,072	1,536	1 : 1	L SKU	Yes	No
2	512 GB x 8	32 GB x 12	384	4,096	4,096	4,480	2,240	1 : 10.7	L SKU	Yes	Yes
2	512 GB x 12	32 GB x 12	384	6,144	6,144	6,528	3,264	1 : 16	L SKU	Yes	Yes
2	512 GB x 8	64 GB x 12	768	4,096	4,096	4,864	2,432	1 : 5.3	L SKU	Yes	Yes
2	512 GB x 12	64 GB x 12	768	6,144	6,144	6,912	3,456	1 : 8	L SKU	Yes	Yes
2	512 GB x 12	128 GB x 12	1,536	6,144	6,144	7,680	3,840	1 : 4	L SKU	Yes	Yes
2	256 GB x 8	16 GB x 12	192	2,048	2,048	2,240	1,120	1 : 10.7	L SKU	Yes	Yes
2	256 GB x 8	32 GB x 12	384	2,048	2,048	2,432	1,216	1 : 5.3	L SKU	Yes	Yes
2	256 GB x 12	32 GB x 12	384	3,072	3,072	3,456	1,728	1 : 8	L SKU	Yes	Yes
2	256 GB x 8	64 GB x 12	768	2,048	N/A	2,816	1,408	1 : 2.7	L SKU	Yes	No
2	256 GB x 12	64 GB x 12	768	3,072	3,072	3,840	1,920	1 : 4	L SKU	Yes	Yes
2	256 GB x 12	128 GB x 12	1,536	3,072	N/A	4,608	2,304	1 : 2	L SKU	Yes	No

**NOTE:** There are limited configurations available for Dual Socket Servers with only one CPU populated.





**NOTE:** PMem is supported on systems with 1600W and 2400W PSU configuration.

- NOTE:**
- High Performance Fan is required with PMem.
  - GPU and FGPA cards are not supported.
  - Mid or rear storage is not supported.
  - Front 12 x 3.5-inch drives are not supported.

## Mode-specific guidelines



The configurations allowed depend on the memory mode selected in the System BIOS.

**Table 25. Memory operating modes**

Memory Operating Mode	Description
<b>Optimizer Mode</b>	The <b>Optimizer Mode</b> if enabled, the DRAM controllers operate independently in the 64-bit mode and provide optimized memory performance.  <b>NOTE:</b> PMem supports only Optimizer mode.
<b>Mirror Mode</b>	The <b>Mirror Mode</b> if enabled, the system maintains two identical copies of data in memory, and the total available system memory is one half of the total installed physical memory. Half of the installed memory is used to mirror the active memory modules. This feature provides maximum reliability and enables the system to continue running even during a catastrophic memory failure by switching over to the mirrored copy. The installation guidelines to enable Mirror Mode require that the memory modules be identical in size, speed, and technology, and they must be populated in sets of 6 per processor.
<b>Single Rank Spare Mode</b>	<b>Single Rank Spare Mode</b> allocates one rank per channel as a spare. If excessive correctable errors occur in a rank or channel, while the operating system is running, they are moved to the spare area to prevent errors from causing an uncorrectable failure. Requires two or more ranks to be populated in each channel.
<b>Multi Rank Spare Mode</b>	<b>Multi Rank Spare Mode</b> allocates two ranks per channel as a spare. If excessive correctable errors occur in a rank or channel, while the operating system is running, they are moved to the spare area to prevent errors from causing an uncorrectable failure. Requires three or more ranks to be populated in each channel.  With single rank memory sparing enabled, the system memory available to the operating system is reduced by one rank per channel.  For example, in a dual-processor configuration with 24x 16 GB dual-rank memory modules, the available system memory is: 3/4 (ranks/channel) × 24 (memory modules) × 16 GB = 288 GB, and not 24 (memory modules) × 16 GB = 384 GB. For multi rank sparing, the multiplier changes to 1/2 (ranks/channel).   <b>NOTE:</b> To use memory sparing, this feature must be enabled in the BIOS menu of System Setup.   <b>NOTE:</b> Memory sparing does not offer protection against a multi-bit uncorrectable error.
<b>Dell Fault Resilient Mode</b>	The <b>Dell Fault Resilient Mode</b> if enabled, the BIOS creates an area of memory that is fault resilient. This mode can be used by an OS that supports the feature to load critical applications or enables the OS kernel to maximize system availability.  <b>NOTE:</b> This feature is only supported in Gold and Platinum Intel processors.   <b>NOTE:</b> Memory configuration has to be of same size DIMM, speed, and rank.

## Optimizer Mode

This mode supports Single Device Data Correction (SDDC) only for memory modules that use x4 device width. It does not impose any specific slot population requirements.

- Dual processor: Populate the slots in round robin sequence starting with processor 1.  
 **NOTE:** Processor 1 and processor 2 population should match.
- Quad processor: Populate the slots in round robin sequence starting with processor 1.  
 **NOTE:** Processor 1, processor 2, processor 3, and processor 4 population should match.

**Table 26. Memory population rules**

Processor	Configuration	Memory population	Memory population information
Single processor	Optimizer (Independent channel) population order	1, 2, 3, 4, 5, 6, 7, 8, 9, 10, 11, 12	<ul style="list-style-type: none"> <li>DIMMs must be populated in the order specified.</li> <li>Odd number of DIMM population is allowed                             <ul style="list-style-type: none"> <li><b>NOTE:</b> Odd number of DIMMs will result in unbalanced memory configurations, which in turn will result in performance loss. It is recommended to populate all memory channels identically with identical DIMMs for best performance.</li> </ul> </li> <li>Optimizer population order is not traditional for 4 and 8 DIMM installations of single processor.                             <ul style="list-style-type: none"> <li>For 4 DIMMs: A1, A2, A4, A5</li> <li>For 8 DIMMs: A1, A2, A4, A5, A7, A8, A10, A11</li> </ul> </li> </ul>
	Mirror population order	{1, 2, 3, 4, 5, 6} {7, 8, 9, 10, 11, 12}	Mirroring is supported with 6 or 12 DIMMs per processor.
	Single rank sparing population order	1, 2, 3, 4, 5, 6, 7, 8, 9, 10, 11, 12	<ul style="list-style-type: none"> <li>DIMMs must be populated in the order specified.</li> <li>Requires two ranks or more per channel.</li> </ul>
	Multi rank sparing population order	1, 2, 3, 4, 5, 6, 7, 8, 9, 10, 11, 12	<ul style="list-style-type: none"> <li>DIMMs must be populated in the order specified.</li> <li>Requires three ranks or more per channel.</li> </ul>
	Fault resilient population order	{1, 2, 3, 4, 5, 6} {7, 8, 9, 10, 11, 12}	Supported with 6 or 12 DIMMs per processor.
Dual processor (Start with processor1. processor1 and processor 2 population should match)	Optimized (Independent channel) population order	A{1}, B{1}, A{2}, B{2}, A{3}, B{3}, A{4}, B{4}, A{5}, B{5}, A{6}, B{6}	<p>Odd number of DIMM population per processor is allowed.</p> <ul style="list-style-type: none"> <li><b>NOTE:</b> Odd number of DIMMs will result in unbalanced memory configurations, which in turn will result in performance loss. It is recommended to populate all memory channels identically with identical DIMMs for best performance.</li> </ul> <p>Optimizer population order is not traditional for 8 and 16 DIMMs installations for dual processor.</p> <ul style="list-style-type: none"> <li>For 8 DIMMs: A1, A2, A4, A5, B1, B2, B4, B5</li> <li>For 16 DIMMs: A1, A2, A4, A5, A7, A8, A10, A11 B1, B2, B4, B5, B7, B8, B10, B11</li> </ul>
	Mirroring population order	A{1, 2, 3, 4, 5, 6}, B{1, 2, 3, 4, 5, 6}, A{7, 8, 9, 10, 11, 12}, B{7, 8, 9, 10, 11, 12}	Mirroring is supported with 6 or 12 DIMMs per processor.
	Single rank sparing population order	A{1}, B{1}, A{2}, B{2}, A{3}, B{3}, A{4}, B{4}, A{5}, B{5}, A{6}, B{6}	<ul style="list-style-type: none"> <li>DIMMs must be populated in the order specified.</li> <li>Requires two ranks or more per channel.</li> </ul>

**Table 26. Memory population rules (continued)**

Processor	Configuration	Memory population	Memory population information
	Multi rank sparing population order	A{1}, B{1}, A{2}, B{2}, A{3}, B{3}, A{4}, B{4}, A{5}, B{5}, A{6}, B{6}	<ul style="list-style-type: none"> <li>• DIMMs must be populated in the order specified.</li> <li>• Requires three ranks or more per channel.</li> </ul>
	Fault resilient population order	A{1, 2, 3, 4, 5, 6}, B{1, 2, 3, 4, 5, 6}, A{7, 8, 9, 10, 11, 12}, B{7, 8, 9, 10, 11, 12}	Supported with 6 or 12 DIMMs per processor.

## Removing a memory module

The procedure for removing a DIMM module, an NVDIMM-N module, and a PMem are identical.

### Prerequisites

1. Follow the safety guidelines listed in [Safety instructions](#) on page 34.
  2. Follow the procedure listed in [Before working inside your system](#) on page 35.
    - ⚠ **CAUTION:** To prevent data loss and potential damage to your system, ensure that your system, LEDs on system, LEDs on NVDIMM-N and LEDs on NVDIMM-N battery are turned off before removing the NVDIMM-N battery.
  3. If applicable, [remove the air shroud](#).
- ⚠ **WARNING:** Allow the memory modules to cool after you power off the system. Handle the memory modules by the card edges and avoid touching the components or metallic contacts on the memory module.
- ⚠ **CAUTION:** To ensure proper system cooling, memory module blanks must be installed in any memory socket that is not occupied. Remove memory module blanks only if you intend to install memory modules in those sockets.

### Steps

1. Locate the appropriate memory module socket.
  - ⚠ **CAUTION:** Handle each memory module only by the card edges, ensuring not to touch the middle of the memory module or metallic contacts.
2. Push the ejectors outward on both ends of the memory module socket to release the memory module from the socket.
3. Lift and remove the memory module from the system.

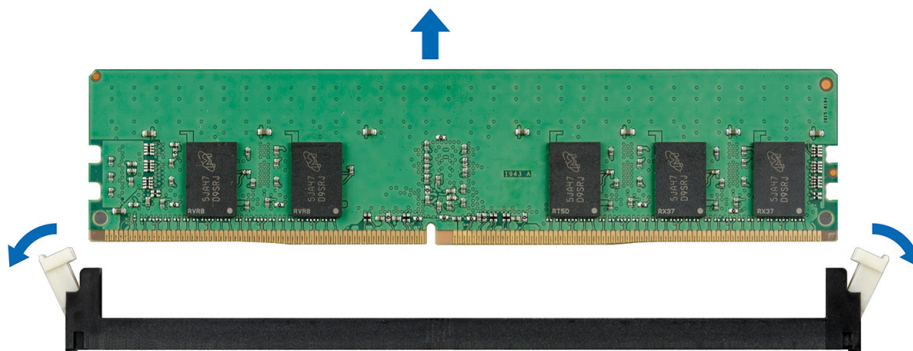

**Figure 39. Removing a memory module**

## Next steps

1. [Install the memory module.](#)
2. If you are removing the memory module permanently, install a memory module blank. The procedure to install a memory module blank is similar to that of the memory module.

## Installing a memory module

The procedure for installing a DIMM module, an NVDIMM-N module, and a PMem are identical.

### Prerequisites

Follow the safety guidelines listed in [Safety instructions](#) on page 34.

**CAUTION:** Ensure that you install the NVDIMM-N battery if you are using NVDIMM-N.

**CAUTION:** To prevent data loss and potential damage to your system, ensure that your system, LEDs on system, LEDs on NVDIMM-N and LEDs on NVDIMM-N battery are turned off before installing the NVDIMM-N battery.

**CAUTION:** To ensure proper system cooling, memory module blanks must be installed in any memory socket that is not occupied. Remove memory module blanks only if you intend to install memory modules in those sockets.

### Steps

1. Locate the appropriate memory module socket.

**CAUTION:** Handle each memory module only by the card edges, ensuring not to touch the middle of the memory module or metallic contacts.

**CAUTION:** To prevent damage to the memory module or the memory module socket during installation, do not bend or flex the memory module. You must insert both ends of the memory module simultaneously.

2. Open the ejectors on the memory module socket outward to allow the memory module to be inserted into the socket.
3. Align the edge connector of the memory module with the alignment key of the memory module socket, and insert the memory module in the socket.

**CAUTION:** Do not apply pressure at the center of the memory module; apply pressure at both ends of the memory module evenly.

**NOTE:** The memory module socket has an alignment key that enables you to install the memory module in the socket in only one orientation.

4. Press the memory module with your thumbs until the socket levers firmly click into place.

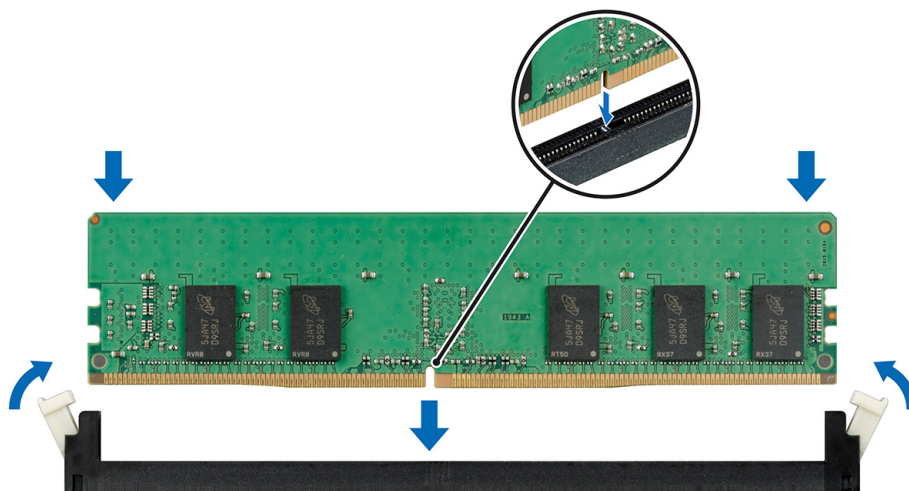

Figure 40. Installing a memory module

**NOTE:** NVDIMM-N memory slots are not hot-pluggable.

### Next steps

1. [Install the air shroud.](#)
2. Follow the procedure listed in [After working inside your system](#) on page 35.
3. To verify if the memory module has been installed properly, press F2 and go to **System Setup Main Menu > System BIOS > Memory Settings**. In the **Memory Settings** screen, the System Memory Size must reflect the updated capacity of the installed memory.
4. If the value is incorrect, one or more of the memory modules may not be installed properly. Ensure that the memory module is firmly seated in the memory module socket.
5. Run the system memory test in system diagnostics.

## NVDIMM-N battery

### Removing the NVDIMM-N battery

#### Prerequisites

1. Follow the safety guidelines listed in [Safety instructions](#) on page 34.
2. Follow the procedure listed in [Before working inside your system](#) on page 35.
  - CAUTION:** To prevent data loss, ensure that your system and LEDs on NVDIMM-N and NVDIMM-N battery are turned off before removing the NVDIMM-N battery.
  - CAUTION:** To avoid damage to the battery connector, you must firmly support the connector while installing or removing a battery.
3. Disconnect the cables from the NVDIMM-N battery.

#### Steps

1. Using the Phillips #2 screwdriver, loosen the screw securing the NVDIMM-N battery.
2. Holding the edges, lift the NVDIMM-N battery away from the system.

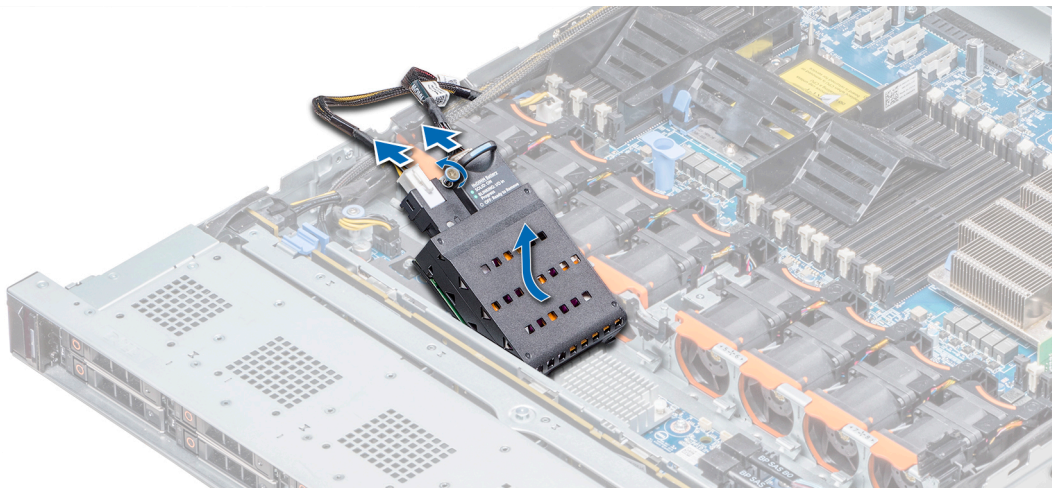

**Figure 41. Removing the NVDIMM-N battery**

#### Next steps

1. [Install the NVDIMM-N battery.](#)



# Installing the NVDIMM-N battery

## Prerequisites

1. Follow the safety guidelines listed in [Safety instructions](#) on page 34.
  - CAUTION:** To prevent data loss, ensure that your system and LEDs on NVDIMM-N and NVDIMM-N battery are turned off before removing the NVDIMM-N battery.
  - CAUTION:** To avoid damage to the battery connector, you must firmly support the connector while installing or removing a battery.

## Steps

1. Holding the edges, align the NVDIMM-N battery with the battery connector on the system board
2. Connect the cables to the NVDIMM-N battery.
3. Using the Phillips #2 screwdriver, tighten the screw to secure the NVDIMM-N battery.

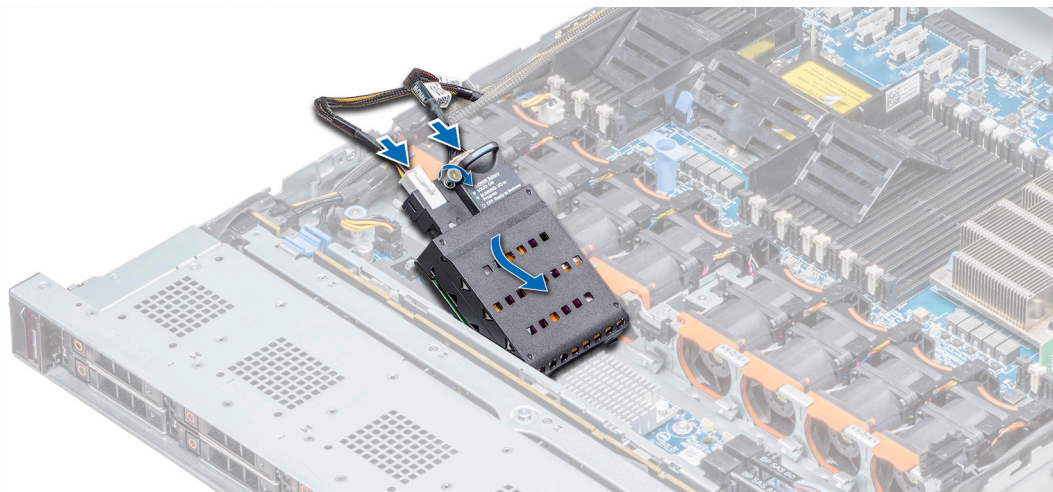

Figure 42. Installing the NVDIMM-N battery

**NOTE:** NVDIMM-N battery is not hot-pluggable.

## Next steps

1. Follow the procedure listed in [After working inside your system](#) on page 35.

# Processors and heat sinks

## Removing a processor and heat sink module

### Prerequisites

**WARNING:** The heat sink may be hot to touch for some time after the system is powered down. Allow the heat sink to cool before removing it.

1. Follow the safety guidelines listed in [Safety instructions](#) on page 34.
2. Follow the procedure listed in [Before working inside your system](#) on page 35.
3. If applicable, [remove the air shroud](#).

### Steps

1. Using a Torx #T30 screwdriver, loosen the screws on the heat sink in the order below:

- a. Loosen the first screw three turns.
  - b. Loosen the second screw completely.
  - c. Return to the first screw and loosen it completely.
2. Pushing both blue retention clips simultaneously, lift the processor and heat sink module (PHM) processor and heat sink module
  3. Set the PHM aside with the processor side facing up.

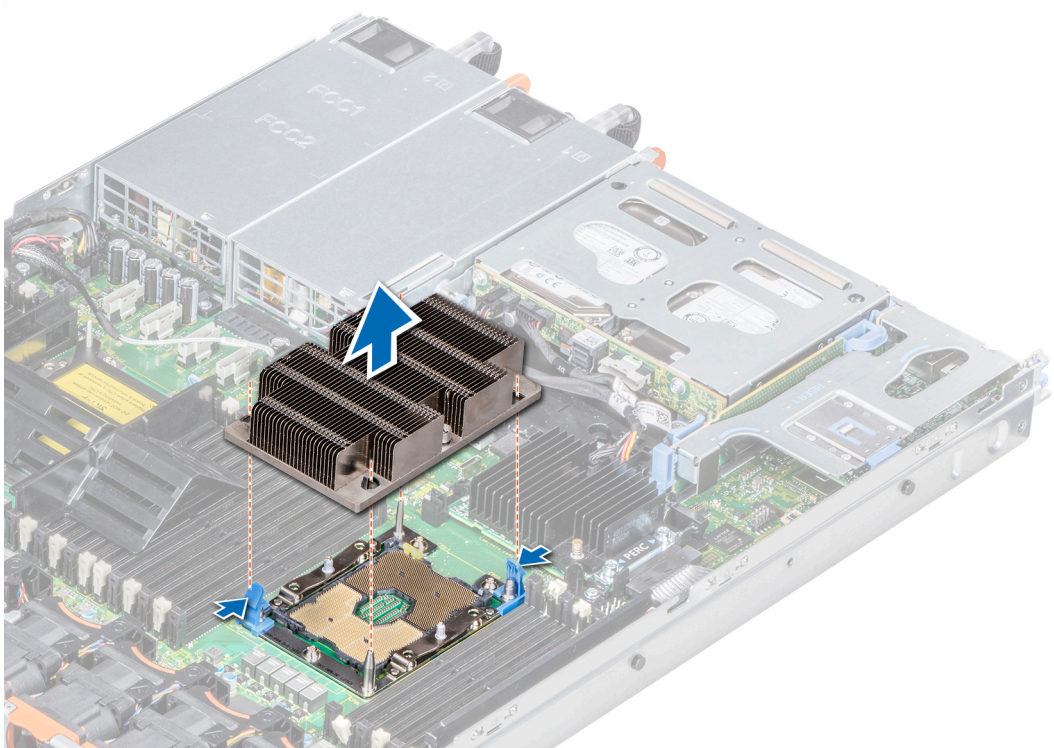

**Figure 43. Removing the processor and heat sink module**

### Next steps

Install the PHM.

## Removing the processor from the processor and heat sink module

### Prerequisites

**NOTE:** Only remove the processor from the processor and heat sink module if you are replacing the processor or heat sink. This procedure is not required when replacing a system board.

1. Follow the safety guidelines listed in [Safety instructions](#) on page 34.
2. Follow the procedure listed in [Before working inside your system](#) on page 35.
3. [Remove the air shroud.](#)
4. [Remove the processor and heat sink module.](#)

### Steps

1. Place the heat sink with the processor side facing up.
2. Insert a flat blade screwdriver into the release slot marked with a yellow label. Twist (do not pry) the screwdriver to break the thermal paste seal.
3. Push the retaining clips on the processor bracket to unlock the bracket from the heat sink.

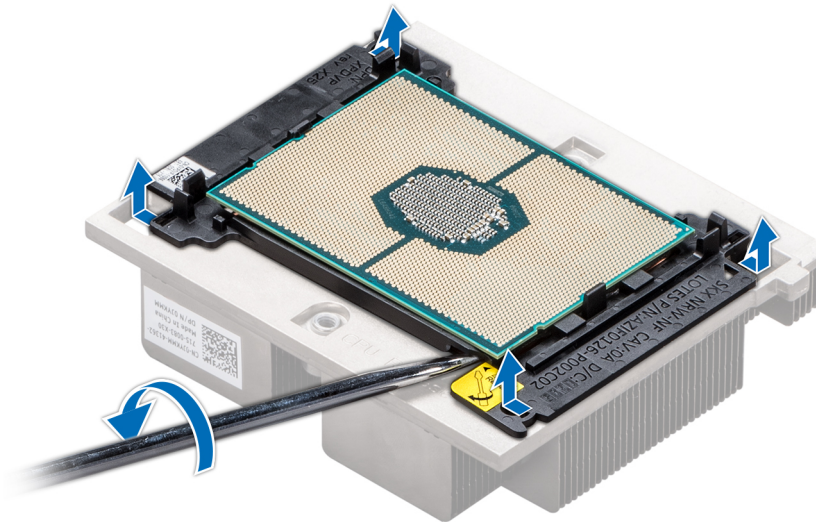

**Figure 44. Loosening the processor bracket**

4. Lift the bracket and the processor away from the heat sink, and place the processor connector side down on the processor tray.
5. Flex the outer edges of the bracket to release the bracket from the processor.

**NOTE:** Ensure that the processor and the bracket are placed in the tray after you remove the heat sink.



**Figure 45. Removing the processor bracket**

### Next steps

Install the processor into the processor and heat sink module.

## Installing the processor into a processor and heat sink module

### Prerequisites

Follow the safety guidelines listed in [Safety instructions](#) on page 34.

## Steps

1. Place the processor in the processor tray.

 **NOTE:** Ensure that the pin 1 indicator on the processor tray is aligned with the pin 1 indicator on the processor.

2. Flex the outer edges of the bracket around the processor ensuring that the processor is locked into the clips on the bracket.  
 **NOTE:** Ensure that the pin 1 indicator on the bracket is aligned with the pin 1 indicator on the processor before placing the bracket on the processor.

 **NOTE:** Ensure that the processor and the bracket are placed in the tray before you install the heat sink.

### Figure 46. Installing the processor bracket

3. If you are using an existing heat sink, remove the thermal grease from the heat sink by using a clean lint-free cloth.
4. Use the thermal grease syringe included with your processor kit to apply the grease in a quadrilateral design on the top of the processor.

 **CAUTION: Applying too much thermal grease can result in excess grease coming in contact with and contaminating the processor socket.**

 **NOTE:** The thermal grease syringe is intended for single use only. Dispose the syringe after you use it.

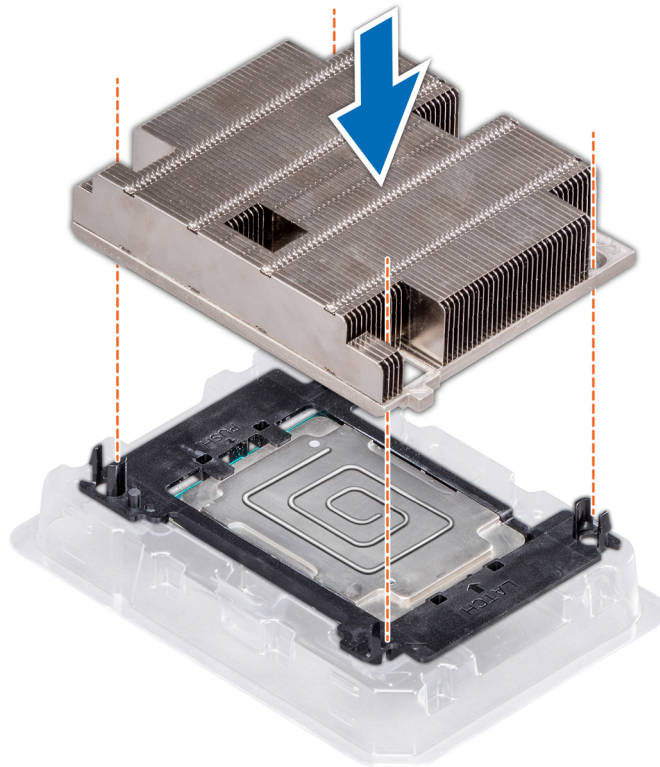

**Figure 47. Applying thermal grease on top of the processor**

5. Place the heat sink on the processor and push down on the base of the heat sink until the bracket locks onto the heat sink.

**i NOTE:**

- Ensure that the two guide pin holes on the bracket match the guide holes on the heat sink.
- Do not press on the heat sink fins.
- Ensure that the pin 1 indicator on the heat sink is aligned with the pin 1 indicator on the bracket before placing the heat sink onto the processor and bracket.



**Figure 48. Installing the heat sink onto the processor**

### Next steps

1. [Install the processor and heat sink module.](#)
2. [Install the air shroud.](#)
3. Follow the procedure listed in [After working inside your system](#) on page 35.

## Installing a processor and heat sink module

### Prerequisites

**CAUTION:** Never remove the heat sink from a processor unless you intend to replace the processor. The heat sink is necessary to maintain proper thermal conditions.

1. Follow the safety guidelines listed in [Safety instructions](#) on page 34.
2. If installed, remove the processor blank and CPU dust cover.

### Steps

1. Align the pin 1 indicator of the heat sink to the system board and then place the processor and heat sink module (PHM) on the processor socket.

**CAUTION:** To avoid damaging the fins on the heat sink, do not press down on the heat sink fins.

**NOTE:** Ensure that the PHM is held parallel to the system board to prevent damaging the components.

2. Push the blue retention clips inward to allow the heat sink to drop into place.
3. Using the Torx #T30 screwdriver, tighten the screws on the heat sink in the order below:
  - a. Partially tighten the first screw (approximately 3 turns).
  - b. Tighten the second screw completely.
  - c. Return to the first screw and tighten it completely.

If the PHM slips off the blue retention clips when the screws are partially tightened, follow these steps to secure the PHM:

- a. Loosen both the heat sink screws completely.
- b. Lower the PHM on to the blue retention clips, following the procedure described in step 2.
- c. Secure the PHM to the system board, following the replacement instructions listed in this step above. 4.

**NOTE:** The processor and heat sink module retention screws should not be tightened to more than 0.13 kgf-m (1.35 N.m or 12 in-lbf).

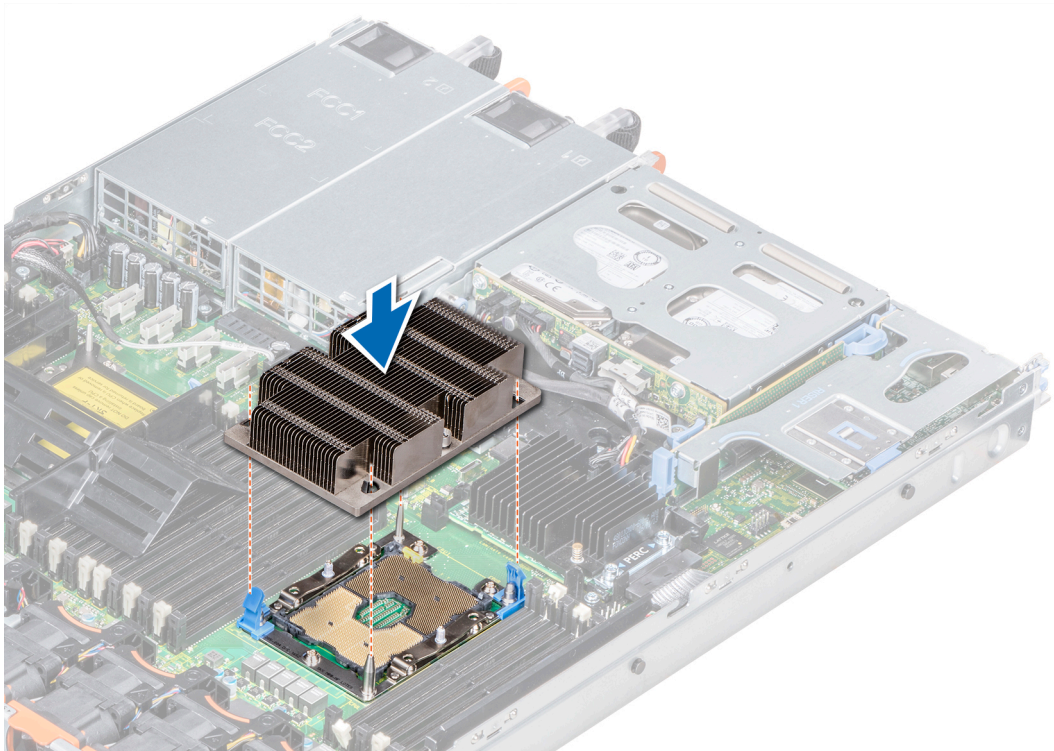

**Figure 49. Installing a processor and heat sink module**

### Next steps

1. Follow the procedure listed in [After working inside your system](#) on page 35.

## Expansion cards and expansion card risers

**NOTE:** A System Event Log (SEL) event is logged if an expansion card riser is not supported or missing. It does not prevent your system from turning on. However, if a F1/F2 pause occurs and an error message is displayed.

### Expansion bus specifications

The PowerEdge R640 system supports PCI express (PCIe) generation 3 expansion cards, which are installed on the system, using expansion card risers. This system supports 1A, 2A, 1B, and 2B expansion card risers.

**NOTE:**

- The expansion card riser slots are not hot-pluggable.
- Internal cable connectors are not hot-pluggable.

### Expansion card installation guidelines

Depending on your system configuration, the following PCI Express (PCIe) generation 3 expansion cards are supported:

**Table 27. Expansion card riser configurations**

Expansion card riser	PCIe slots on the riser	Processor connection	Height	Length	Slot width
Riser 1A	Slot 1	Processor 1	Low Profile	Half Length	x16
	Slot 2	Processor 1	Low Profile	Half Length	x16
Riser 2A	Slot 3	Processor 2	Low Profile	Half Length	x16
Riser 1B	Slot 1	Processor 1	Low Profile	Half Length	x16
Riser 2B	Slot 2	Processor 2	Full Height	Three-fourth Length	x16
Riser 1B	Slot 1	Processor 1	Low Profile	Half Length	x16

 **NOTE:** The expansion card slots are not hot-swappable.

The following table provides guidelines for installing expansion cards to ensure proper cooling and mechanical fit. The expansion cards with the highest priority should be installed first using the slot priority indicated. All the other expansion cards should be installed in the card priority and slot priority order.

**Table 28. Riser configurations: 1B**

Card Type	Slot Priority	Form Factor
HWRAID BOSS (ODM)	1	Low Profile
NVMe PCIe SSD (Dell design)	1	Low Profile
Infiniband HCA EDR (Mellanox)	1	Low Profile
100G NICs (Mellanox)	1	Low Profile
Omni-Path HFI (Intel)	1	Low Profile
Infiniband HCA FDR (Mellanox)	1	Low Profile
40G NICs (Intel)	1	Low Profile
40G NICs (Mellanox)	1	Low Profile
FC32 HBA (QLogic)	1	Low Profile
FC32 HBA (Emulex)	1	Low Profile
25G NICs (Broadcom)	1	Low Profile
25G NICs (Mellanox)	1	Low Profile
25G NICs (QLogic)	1	Low Profile
FC16 HBA (QLogic)	1	Low Profile
FC16 HBA (Emulex)	1	Low Profile
10Gb NICs (Broadcom)	1	Low Profile
10Gb NICs (Intel)	1	Low Profile
10Gb NICs (Mellanox)	1	Low Profile
10Gb NICs (QLogic)	1	Low Profile
10Gb NICs (Solarflare)	1	Low Profile
FC8 HBA (Emulex)	1	Low Profile
FC8 HBA (QLogic)	1	Low Profile
1Gb NICs (Broadcom)	1	Low Profile
1Gb NICs (Intel)	1	Low Profile



**Table 28. Riser configurations: 1B (continued)**

Card Type	Slot Priority	Form Factor
Adapter RAID (Dell design)	1	Low Profile
External RAID (Dell design)	1	Low Profile
Non-RAID (Dell design)	1	Low Profile
Integrated RAID (Dell design)	Integrated Slot	NONE
rNDC (Broadcom)	Integrated Slot	NONE
rNDC (Intel)	Integrated Slot	NONE
rNDC (Mellanox)	Integrated Slot	NONE
rNDC (QLogic)	Integrated Slot	NONE

**Table 29. Riser configurations: 1A + 2A**

Card type	Slot priority	Form factor
Graphics processing unit (GPU)	1, 3, 2	Low Profile
Adapter RAID (Dell design)	1, 3	Low Profile
HWRAID BOSS (ODM)	1, 2, 3	Low Profile
NVMe PCIe SSD (Dell design)	3, 1	Low Profile
Infiniband HCA EDR (Mellanox)	1, 2, 3	Low Profile
100G NICs (Mellanox)	1, 2, 3	Low Profile
Omni-Path HFI (Intel)	1, 2, 3	Low Profile
Infiniband HCA FDR (Mellanox)	1, 2, 3	Low Profile
40G NICs (Intel)	1, 2, 3	Low Profile
40G NICs (Mellanox)	1, 2, 3	Low Profile
FC32 HBA (QLogic)	1, 2, 3	Low Profile
FC32 HBA (Emulex)	1, 2, 3	Low Profile
25G NICs (Broadcom)	1, 2, 3	Low Profile
25G NICs (Mellanox)	1, 2, 3	Low Profile
25G NICs (QLogic)	1, 2, 3	Low Profile
FC16 HBA (QLogic)	1, 2, 3	Low Profile
FC16 HBA (Emulex)	1, 2, 3	Low Profile
10Gb NICs (Broadcom)	1, 2, 3	Low Profile
10Gb NICs (Intel)	1, 2, 3	Low Profile
10Gb NICs (Mellanox)	1, 2, 3	Low Profile
10Gb NICs (QLogic)	1, 2, 3	Low Profile
10Gb NICs (Solarflare)	1, 2, 3	Low Profile
FC8 HBA (Emulex)	1, 3	Low Profile
FC8 HBA (QLogic)	1, 2, 3	Low Profile
1Gb NICs (Broadcom)	1, 2, 3	Low Profile
1Gb NICs (Intel)	1, 2, 3	Low Profile
External RAID (Dell design)	1, 2, 3	Low Profile

**Table 29. Riser configurations: 1A + 2A (continued)**

Card type	Slot priority	Form factor
Non-RAID (Dell design)	1, 3	Low Profile
Integrated RAID (Dell design)	Integrated Slot	NONE
rNDC (Broadcom)	Integrated Slot	NONE
rNDC (Intel)	Integrated Slot	NONE
rNDC (Mellanox)	Integrated Slot	NONE
rNDC (QLogic)	Integrated Slot	NONE

**Table 30. Riser configurations: 1B + 2B**

Card type	Slot priority	Form factor
GPU (NVIDIA)	2	Full Height
HWRAID BOSS (ODM)	1	Low Profile
NVMe PCIe SSD (Dell design)	1	Low Profile
Infiniband HCA EDR (Mellanox)	1	Low Profile
100G NICs (Mellanox)	1	Low Profile
Omni-Path HFI (Intel)	1	Low Profile
Infiniband HCA FDR (Mellanox)	1	Low Profile
40G NICs (Intel)	1	Low Profile
40G NICs (Mellanox)	1	Low Profile
FC32 HBA (QLogic)	1	Low Profile
FC32 HBA (Emulex)	1	Low Profile
25G NICs (Broadcom)	1	Low Profile
25G NICs (Mellanox)	1	Low Profile
25G NICs (QLogic)	1	Low Profile
FC16 HBA (QLogic)	1	Low Profile
FC16 HBA (Emulex)	1	Low Profile
10Gb NICs (Broadcom)	1	Low Profile
10Gb NICs (Intel)	1	Low Profile
10Gb NICs (Mellanox)	1	Low Profile
10Gb NICs (QLogic)	1	Low Profile
10Gb NICs (Solarflare)	1	Low Profile
FC8 HBA (Emulex)	1	Low Profile
FC8 HBA (QLogic)	1	Low Profile
1Gb NICs (Broadcom)	1	Low Profile
1Gb NICs (Intel)	1	Low Profile
Adapter RAID (Dell design)	1	Low Profile
External RAID (Dell design)	1	Low Profile
Non-RAID (Dell design)	1	Low Profile
HWRAID BOSS (ODM)	2	Full Height

**Table 30. Riser configurations: 1B + 2B (continued)**

<b>Card type</b>	<b>Slot priority</b>	<b>Form factor</b>
Infiniband HCA EDR (Mellanox)	2	Full Height
100G NICs (Mellanox)	2	Full Height
Omni-Path HFI (Intel)	2	Full Height
40G NICs (Intel)	2	Full Height
40G NICs (Mellanox)	2	Full Height
FC32 HBA (QLogic)	2	Full Height
FC32 HBA (Emulex)	2	Full Height
25G NICs (Broadcom)	2	Full Height
25G NICs (Mellanox)	2	Full Height
25G NICs (QLogic)	2	Full Height
FC16 HBA (QLogic)	2	Full Height
FC16 HBA (Emulex)	2	Full Height
10Gb NICs (Broadcom)	2	Full Height
10Gb NICs (Intel)	2	Full Height
10Gb NICs (Mellanox)	2	Full Height
10Gb NICs (QLogic)	2	Full Height
10Gb NICs (Solarflare)	2	Full Height
FC8 HBA (Emulex)	2	Full Height
FC8 HBA (QLogic)	2	Full Height
1Gb NICs (Broadcom)	2	Full Height
1Gb NICs (Intel)	2	Full Height
External RAID (Dell design)	2	Full Height
Non-RAID (Dell design)	2	Full Height
Low-end Video (Dell design)	2	Full Height
Integrated RAID (Dell design)	Integrated Slot	NONE
rNDC (Broadcom)	Integrated Slot	NONE
rNDC (Intel)	Integrated Slot	NONE
rNDC (Mellanox)	Integrated Slot	NONE
rNDC (QLogic)	Integrated Slot	NONE

**Table 31. Riser configurations:1A**

<b>Card type</b>	<b>Slot priority</b>	<b>Form factor</b>
Adapter RAID (Dell design)	1	Low Profile
Non-RAID (Dell design)	1	Low Profile
HWRAID BOSS (ODM)	1, 2	Low Profile
NVMe PCIe SSD (Dell design)	1	Low Profile
Infiniband HCA EDR (Mellanox)	1, 2	Low Profile
100G NICs (Mellanox)	1, 2	Low Profile

**Table 31. Riser configurations:1A (continued)**

Card type	Slot priority	Form factor
Omni-Path HFI (Intel)	1, 2	Low Profile
Infiniband HCA FDR (Mellanox)	1, 2	Low Profile
40G NICs (Intel)	1, 2	Low Profile
40G NICs (Mellanox)	1, 2	Low Profile
FC32 HBA (QLogic)	1, 2	Low Profile
FC32 HBA (Emulex)	1, 2	Low Profile
25G NICs (Broadcom)	1, 2	Low Profile
25G NICs (Mellanox)	1, 2	Low Profile
25G NICs (QLogic)	1, 2	Low Profile
FC16 HBA (QLogic)	1, 2	Low Profile
FC16 HBA (Emulex)	1, 2	Low Profile
10Gb NICs (Broadcom)	1, 2	Low Profile
10Gb NICs (Intel)	1, 2	Low Profile
10Gb NICs (Mellanox)	1, 2	Low Profile
10Gb NICs (QLogic)	1, 2	Low Profile
10Gb NICs (Solarflare)	1, 2	Low Profile
FC8 HBA (Emulex)	1	Low Profile
FC8 HBA (QLogic)	1, 2	Low Profile
1Gb NICs (Broadcom)	1, 2	Low Profile
1Gb NICs (Intel)	1, 2	Low Profile
External RAID (Dell design)	1, 2	Low Profile
Integrated RAID (Dell design)	Integrated Slot	NONE
rNDC (Broadcom)	Integrated Slot	NONE
rNDC (Intel)	Integrated Slot	NONE
rNDC (Mellanox)	Integrated Slot	NONE
rNDC (QLogic)	Integrated Slot	NONE

## Removing an expansion card riser

### Prerequisites

1. Follow the safety guidelines listed in [Safety instructions](#) on page 34.
2. Follow the procedure listed in [Before working inside your system](#) on page 35.
3. Before removing the expansion card riser 2A, remove the expansion card from the riser, if installed.
4. Disconnect any cables connected to the expansion card.

### Steps

Hold the touch points, and lift the expansion card riser, from the riser connector, on the system board.

 **NOTE:** While removing the riser 1B, press the tabs and hold the touch point to lift the expansion card riser from the system board.

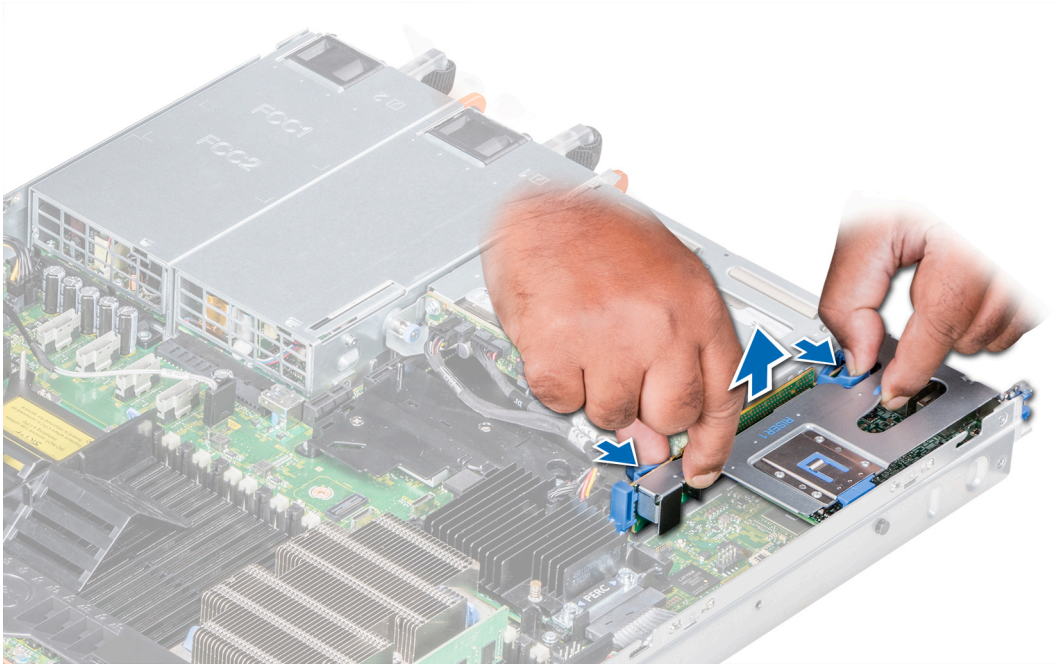

Figure 50. Removing the expansion riser 1B

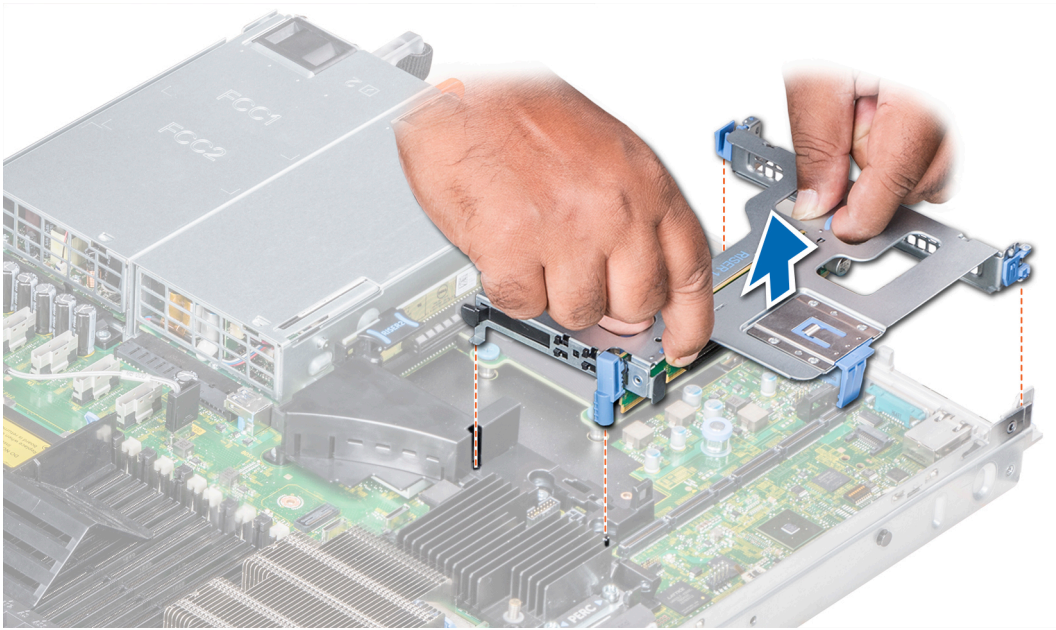
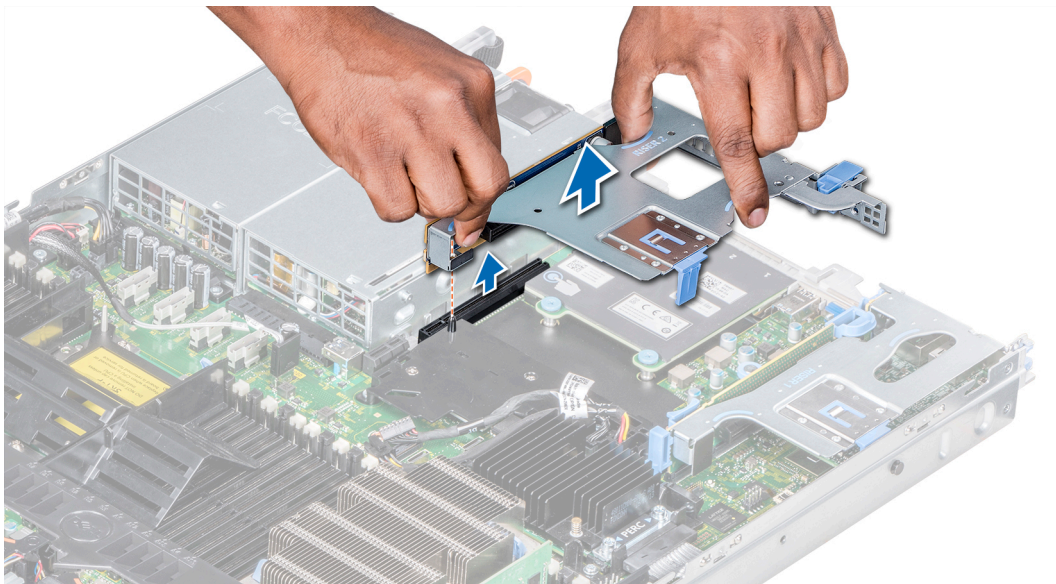

Figure 51. Removing the expansion riser 1A



**Figure 52. Removing the expansion riser 2A**



**Figure 53. Removing the expansion riser 2B**

### **Next steps**

Install the expansion card riser.

## **Installing an expansion card riser**

### **Prerequisites**

1. Follow the safety guidelines listed in [Safety instructions](#) on page 34.
2. Before installing the expansion card riser 2A, install an expansion card into the riser, if applicable.

### **Steps**

1. If removed, [install the expansion cards into the expansion card riser](#).
2. Holding the touch points, align the expansion card riser with the connector and the riser guide pin on the system board.

**NOTE:** While installing riser 1B, press the tabs and hold the touch point to align the expansion card riser and the riser guide pin on the system board.

3. Lower the expansion card riser into place until the expansion card riser connector is fully seated in the connector.

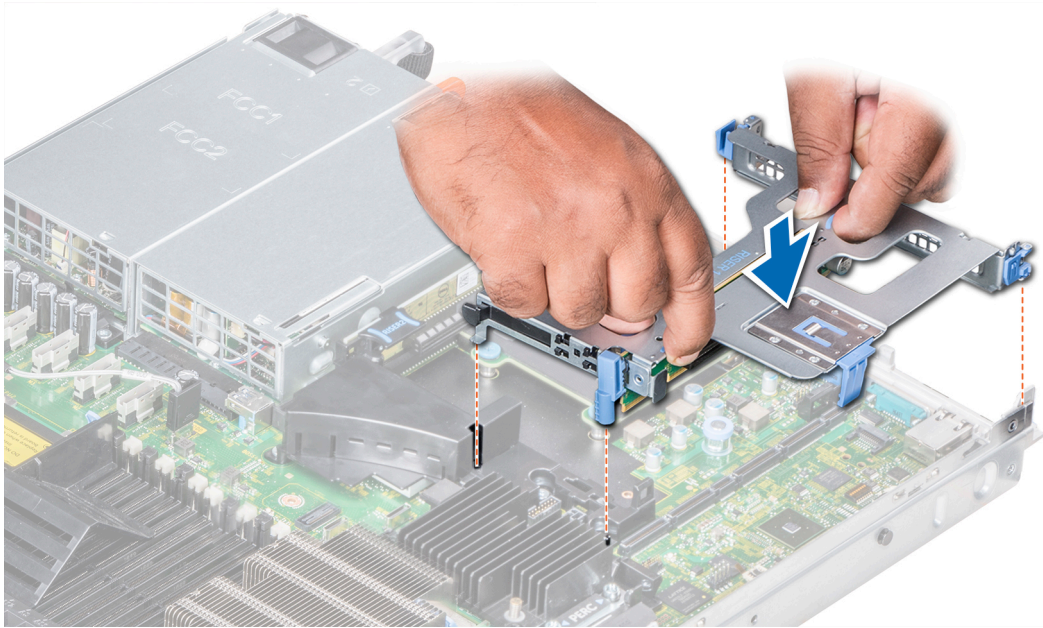

**Figure 54. Installing the expansion riser 1A**

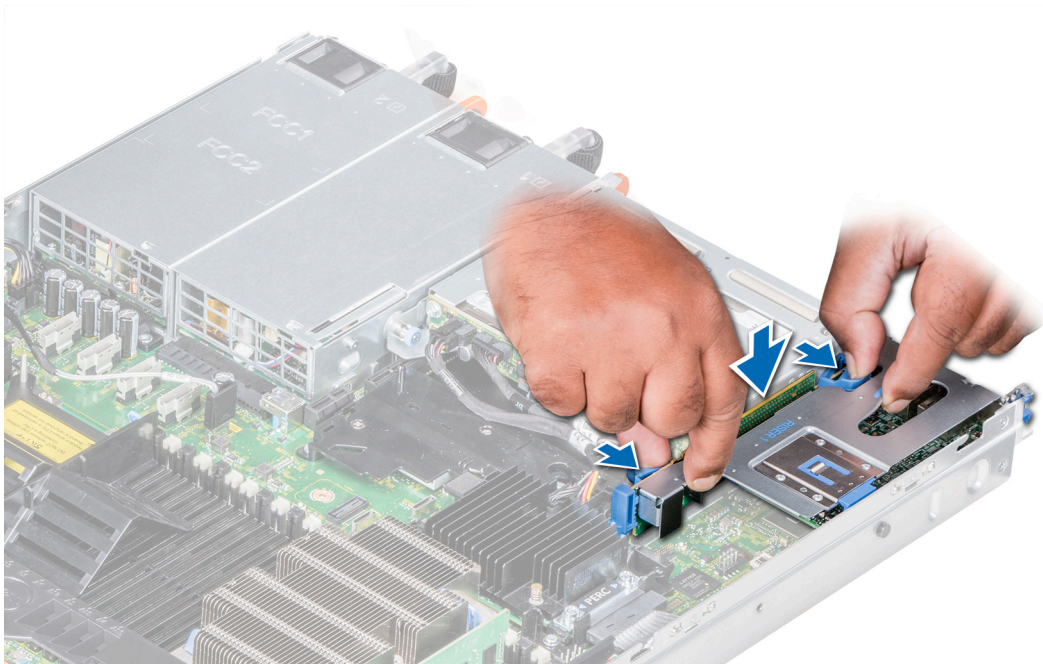

**Figure 55. Installing the expansion riser 1B**

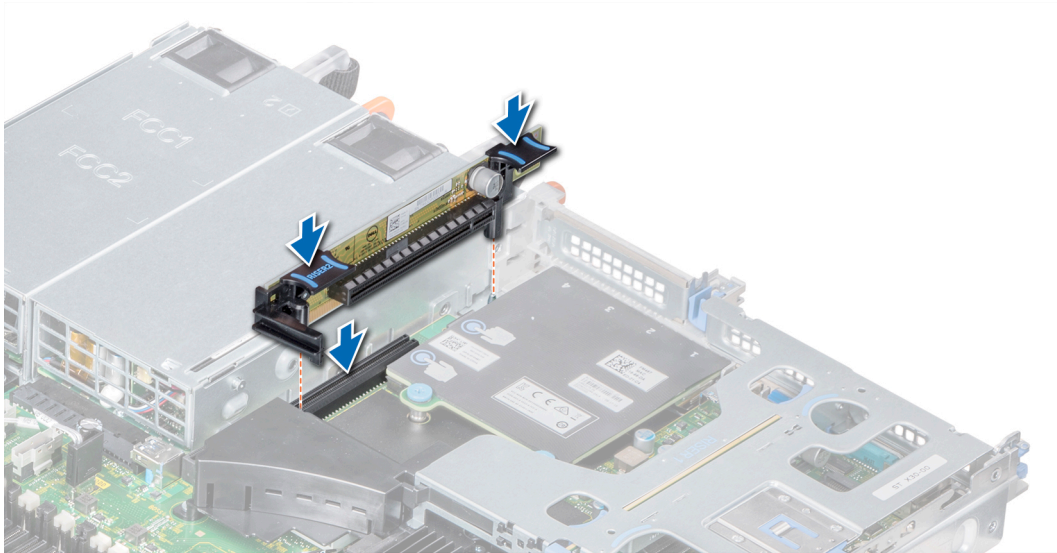

**Figure 56. Installing the expansion riser 2A**

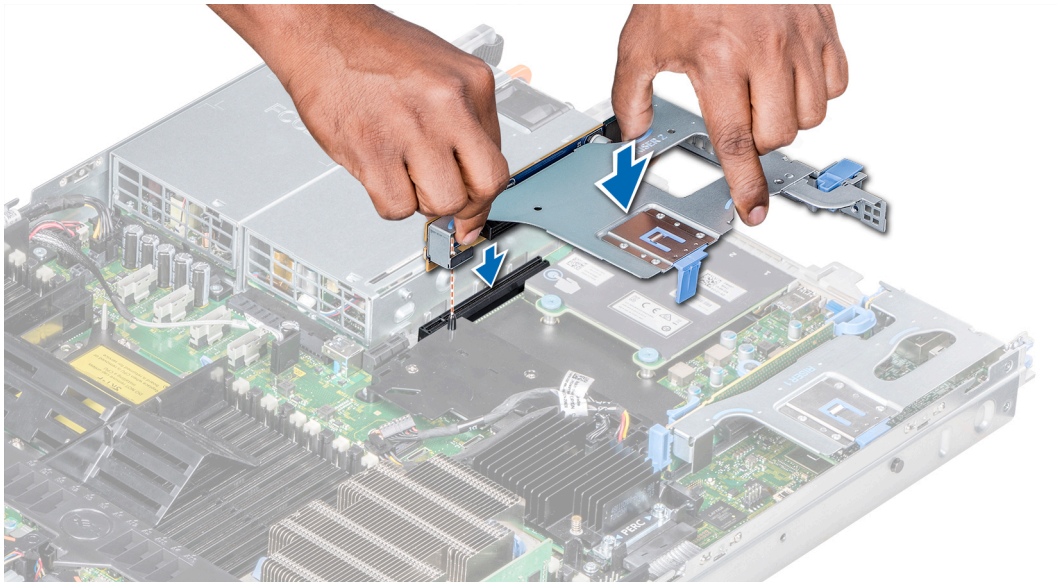

**Figure 57. Installing the expansion riser 2B**

### Next steps

1. Follow the procedure listed in [After working inside your system](#) on page 35.
2. Install any device drivers required for the card as described in the documentation for the card.

## Removing expansion card from the expansion card riser

### Prerequisites

1. Follow the safety guidelines listed in [Safety instructions](#) on page 34.
2. Follow the procedure listed in [Before working inside your system](#) on page 35.
3. If applicable, [remove the air shroud](#).
4. If applicable, disconnect the cables from the expansion card.
5. When removing a card from riser 2 or 3, ensure that the PCIe card holder latch is closed.



## Steps

1. Pull the expansion card latch out of the slot.
2. Hold the expansion card by its edges, and pull the card until the card edge connector disengages from the expansion card connector on the riser.

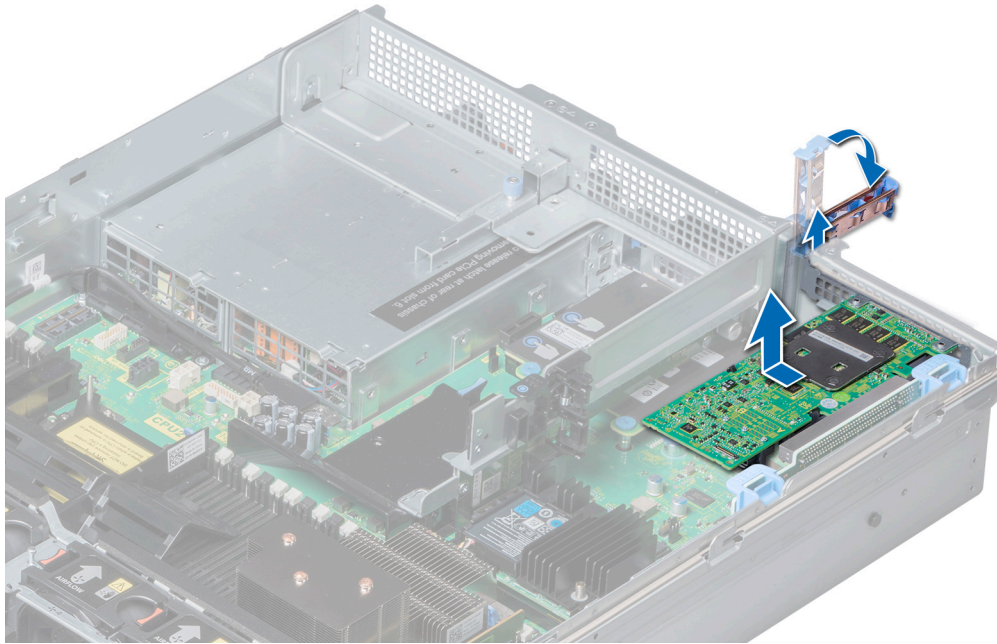

Figure 58. Removing the expansion card from expansion card riser 1

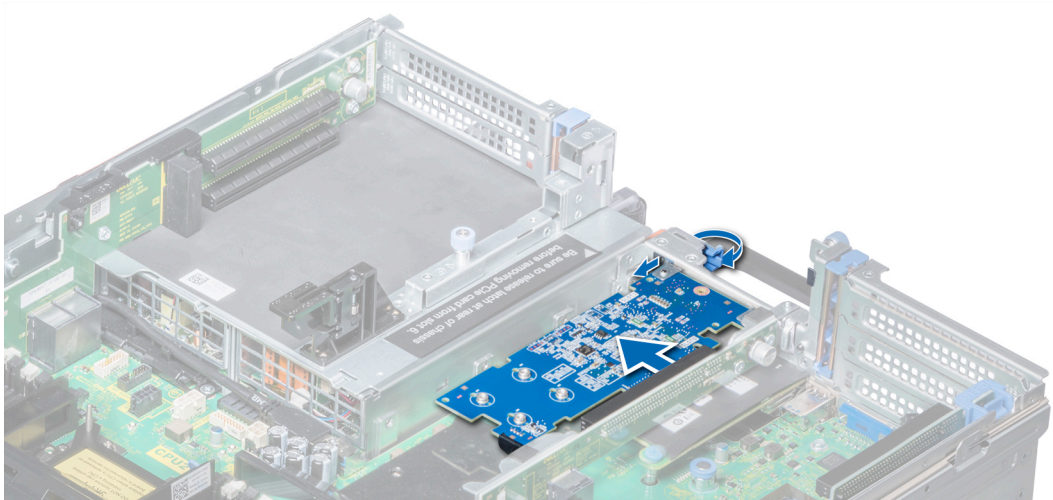
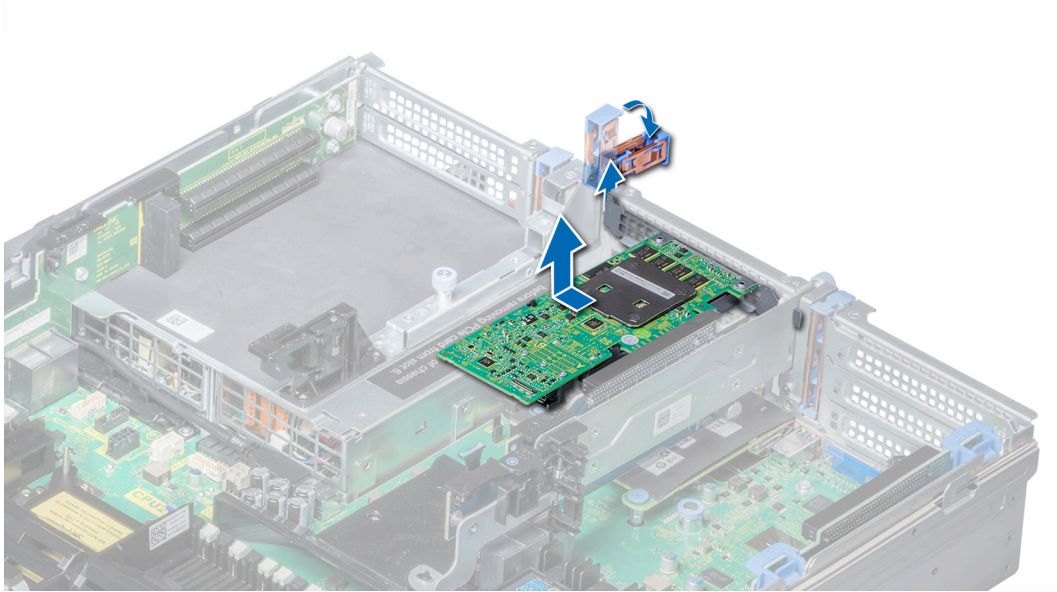
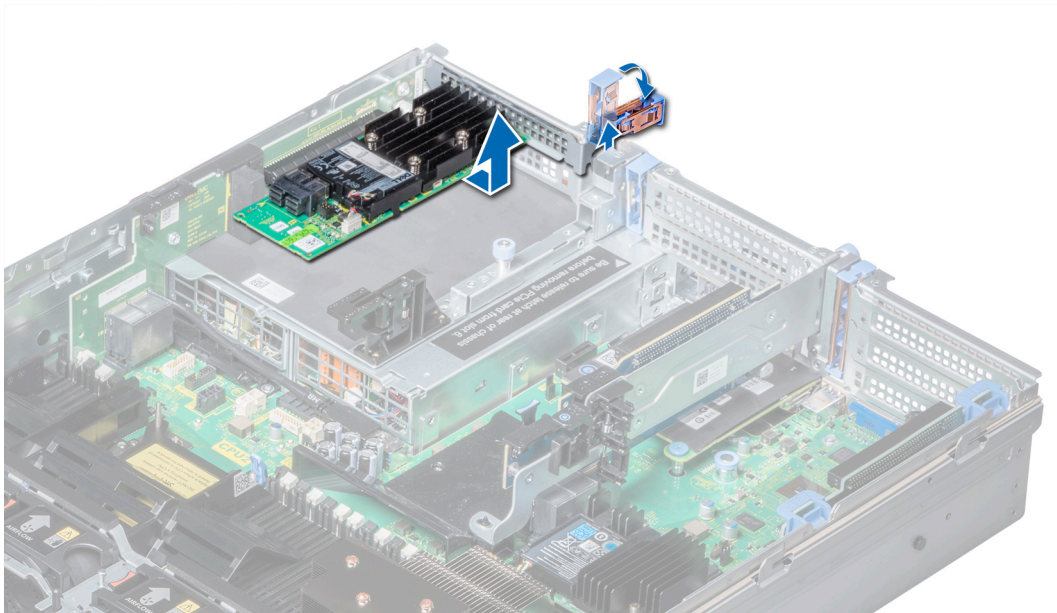

Figure 59. Removing the expansion card from expansion card riser 2B



**Figure 60. Removing the expansion card from expansion card riser 2**



**Figure 61. Removing the expansion card from expansion card riser 3**

### Next steps

1. Install expansion card into the expansion card riser.
2. If you are removing the card permanently, install a metal filler bracket over the empty expansion slot opening and push the expansion card latch.

**i NOTE:** You must install a filler bracket over an empty expansion card slot to maintain Federal Communications Commission (FCC) certification of the system. The brackets also keep dust and dirt out of the system and aid in proper cooling and airflow inside the system.

# Installing an expansion card into expansion card riser

## Prerequisites

1. Follow the safety guidelines listed in [Safety instructions](#) on page 34.
2. Unpack the expansion card and prepare it for installation.
  - i** **NOTE:** For instructions, see the documentation accompanying the card.
  - i** **NOTE:** When installing a card into the riser 1, open the PCIe card holder latch. If applicable, open the PCIe guide and then install the expansion card.

## Steps

1. If applicable, lift the expansion card latch and remove the filler bracket.
  - i** **NOTE:** Store the filler bracket for future use. Filler brackets must be installed in empty expansion card slots to maintain Federal Communications Commission (FCC) certification of the system. The brackets also keep dust and dirt out of the system and aid in proper cooling and airflow inside the system.

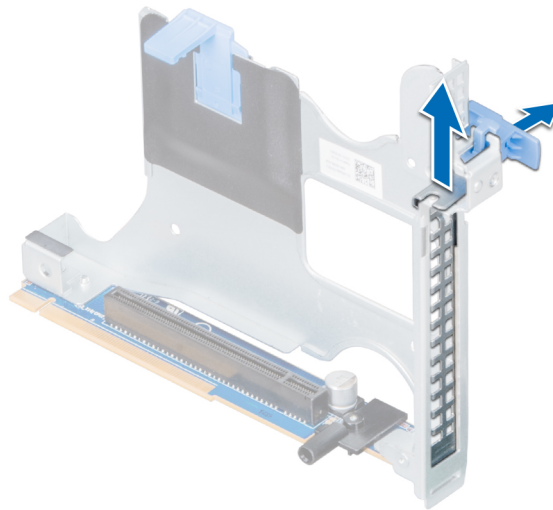
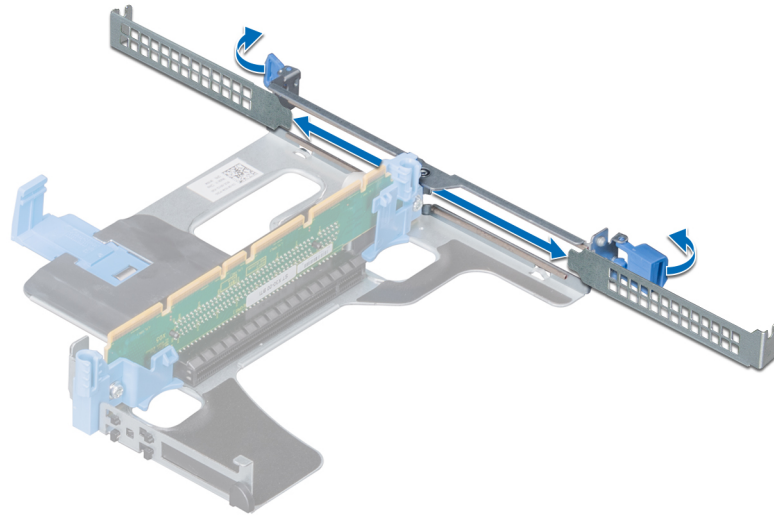
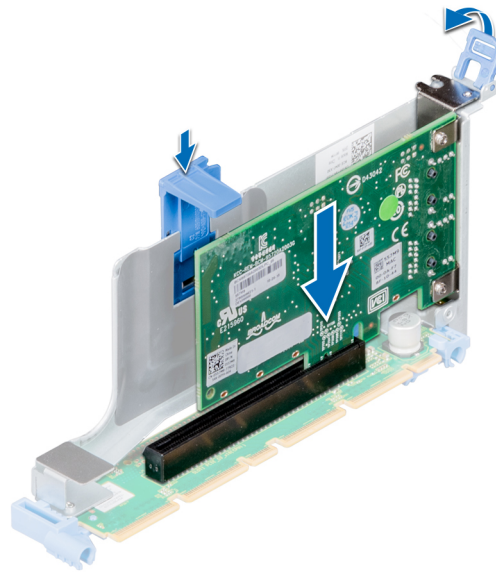

Figure 62. Removing the metal filler bracket on Riser 2B



**Figure 63. Removing the metal filler bracket on Riser 1A**

2. Hold the card by its edges, and align the card edge connector with the expansion card connector on the riser.
3. Insert the card edge connector firmly into the expansion card connector until the card is fully seated.
4. Close the expansion card latch.



**Figure 64. Installing an expansion card into the expansion riser 1B**

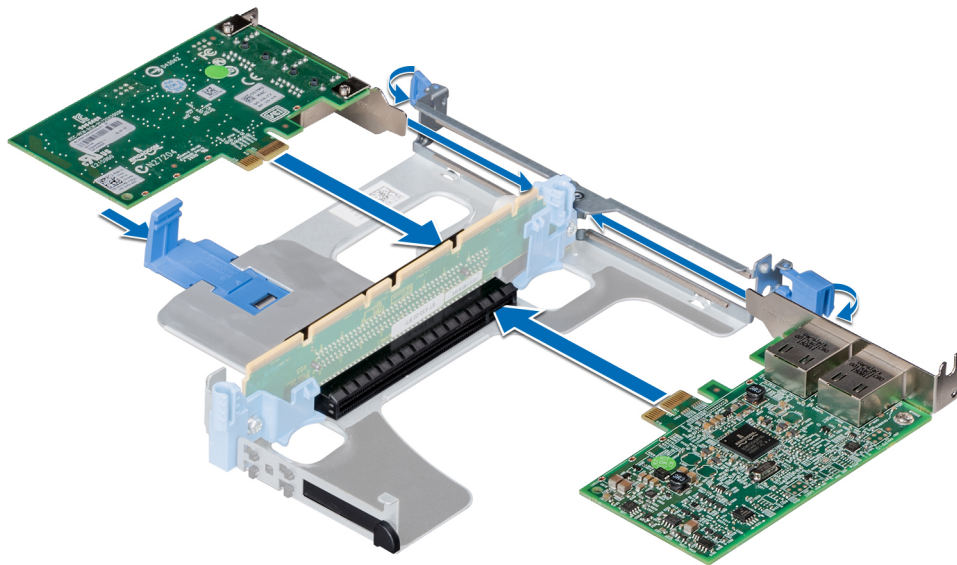

Figure 65. Installing expansion cards into the expansion riser 1A

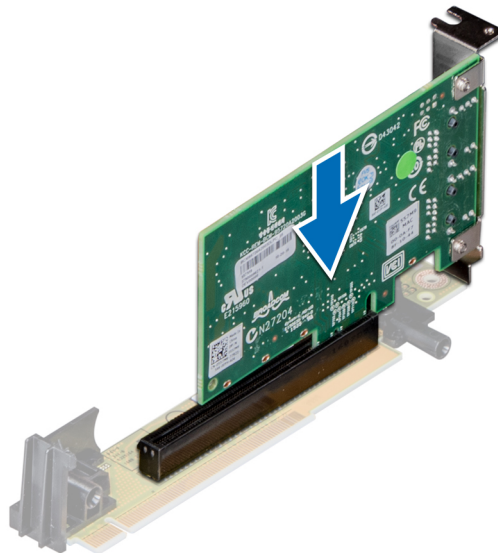

Figure 66. Installing an expansion card into the expansion riser 2A

### Next steps

1. After installing a card into the riser 1, close the PCIe card holder latch. If applicable, close the PCIe guide after installing the expansion card.
2. Follow the procedure listed in [After working inside your system](#) on page 35.
3. Install any device drivers required for the card as described in the documentation for the card.

## M.2 SSD module

### Removing the M.2 SSD module

#### Prerequisites

1. Follow the safety guidelines listed in [Safety instructions](#) on page 34.

2. Follow the procedure listed in [Before working inside your system](#) on page 35.
3. [Remove the air shroud](#).
4. Remove the BOSS card.

**NOTE:** Removing the BOSS card is similar to the procedure for removing an expansion card riser.

### Steps

1. Loosen the screws and lift the retention straps that secure the M.2 SSD module on the BOSS card.
2. Pull the M.2 SSD module away from the BOSS card.

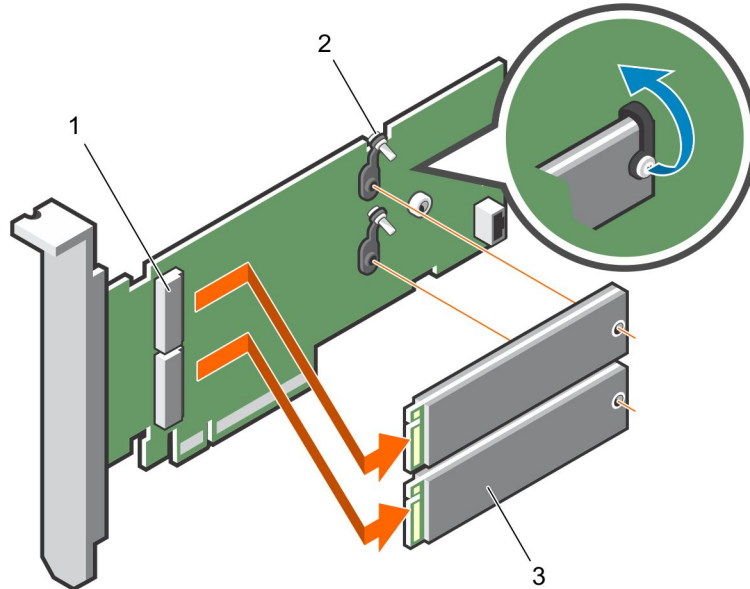

**Figure 67. Removing the M.2 SSD module**

- a. module connector (2)
- b. screws (2)
- c. module (2)

### Next steps

[Install the M.2 SSD module](#).

## Installing the M.2 SSD module

### Prerequisites

1. Follow the safety guidelines listed in [Safety instructions](#) on page 34.

### Steps

1. Align the M.2 SSD module connectors with the connectors on the BOSS card.
2. Push the M.2 SSD module until the module is seated firmly on the BOSS card.
3. Secure the M.2 SSD module on the BOSS card with the retention straps and screws.

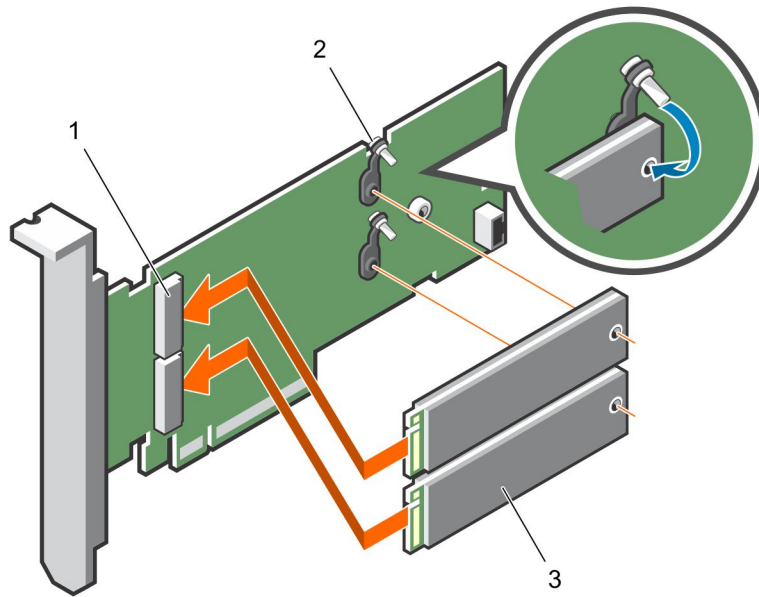

**Figure 68. Installing the M.2 SSD module**

- a. module connector (2)
- b. screws (2)
- c. modules (2)

#### Next steps

1. Install the BOSS card.
  - i** **NOTE:** Installing the BOSS card is similar to installing the expansion card riser.
2. [Install the air shroud.](#)
3. Follow the procedure listed in [After working inside your system](#) on page 35.

## Optional IDSDM or vFlash module

**i** **NOTE:** The write-protect switch is on the IDSDM or vFlash module.

## Removing the optional IDSDM or vFlash card

#### Prerequisites

1. Follow the safety guidelines listed in [Safety instructions](#) on page 34.
2. Follow the procedure listed in [After working inside your system](#) on page 35.
3. If you are replacing the IDSDM/vFlash card, remove the MicroSD cards.
  - i** **NOTE:** Temporarily label each MicroSD card with its corresponding slot number after removal.

#### Steps

1. Locate the IDSDM/vFlash connector on the system board.
  - To locate IDSDM/vFlash connector, see the [System board jumpers and connectors](#) section.
2. Holding the pull tab, lift the IDSDM/vFlash card out of the system.

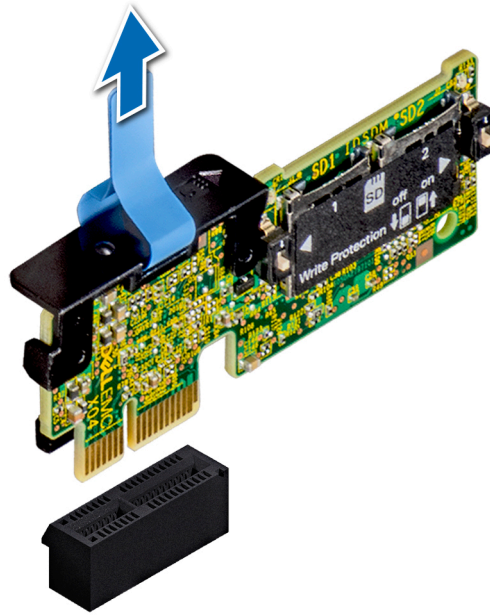

**Figure 69. Removing the optional IDSDM module**

**NOTE:** There are two dip switches on the IDSDM module for write-protection.

#### Next steps

Install the optional IDSDM/vFlash card.

## Installing optional IDSDM or vFlash card

#### Prerequisites

Follow the safety guidelines listed in [Safety instructions](#) on page 34.

#### Steps

1. Locate the IDSDM/vFlash connector on the system board.  
To locate IDSDM/vFlash connector, see the [System board jumpers and connectors](#) on page 137 section.
2. Align the IDSDM/vFlash card with the connector on the system board.
3. Push the IDSDM/vFlash card until it is firmly seated on the system board.



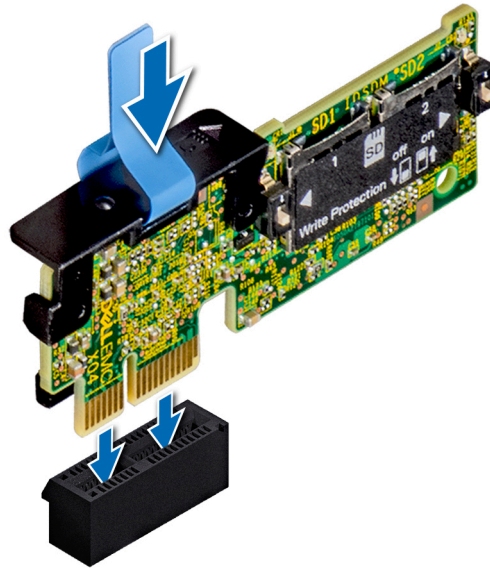

Figure 70. Installing optional IDSDM module

### Next steps

1. Install the MicroSD cards.
  - NOTE:** Reinstall the MicroSD cards into the same slots based on the labels you had marked on the cards during removal.
2. Follow the procedure listed in [After working inside your system](#) on page 35.

## Optional IDSDM or vFlash module

**NOTE:** The write-protect switch is on the IDSDM or vFlash module.

## Removing the MicroSD card

### Prerequisites

1. Follow the safety guidelines listed in [Safety instructions](#) on page 34.
2. Follow the procedure listed in [Before working inside your system](#) on page 35.

### Steps

1. Locate the MicroSD card slot on the vFlash/IDSDM module, and press the card to partially release it from the slot. To locate IDSDM/vFlash module, see the [System board jumpers and connectors](#) section.
2. Hold the MicroSD card and remove it from the slot.

**NOTE:** Temporarily label each MicroSD card with its corresponding slot number after removal.

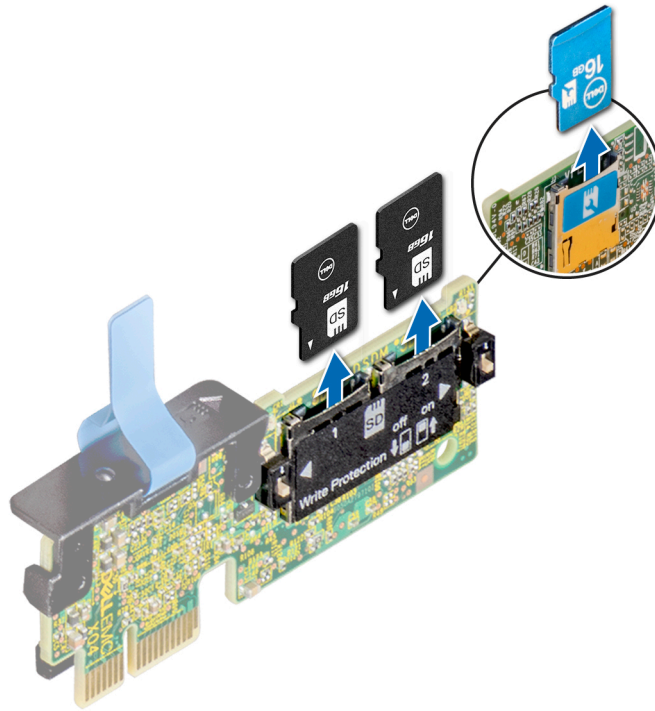

**Figure 71. Removing the MicroSD card**

#### Next steps

1. Follow the procedure listed in [After working inside your system](#) on page 35.
2. [Install a MicroSD card.](#)

## Installing the MicroSD card

#### Prerequisites

Follow the safety guidelines listed in [Safety instructions](#) on page 34.

- NOTE:** To use an MicroSD card with your system, ensure that the **Internal SD Card Port** is enabled in System Setup.
- NOTE:** If reinstalling, ensure that you install the MicroSD cards into the same slots based on the labels you had marked on the cards during removal.

#### Steps

1. Locate the MicroSD card connector on the IDSDM/vFlash module. Orient the MicroSD card appropriately and insert the contact-pin end of the card into the slot. To locate IDSDM/vFlash, see the [System board jumpers and connectors](#) section.
  - NOTE:** The slot is keyed to ensure correct insertion of the card.
2. Press the card into the card slot to lock it into place.

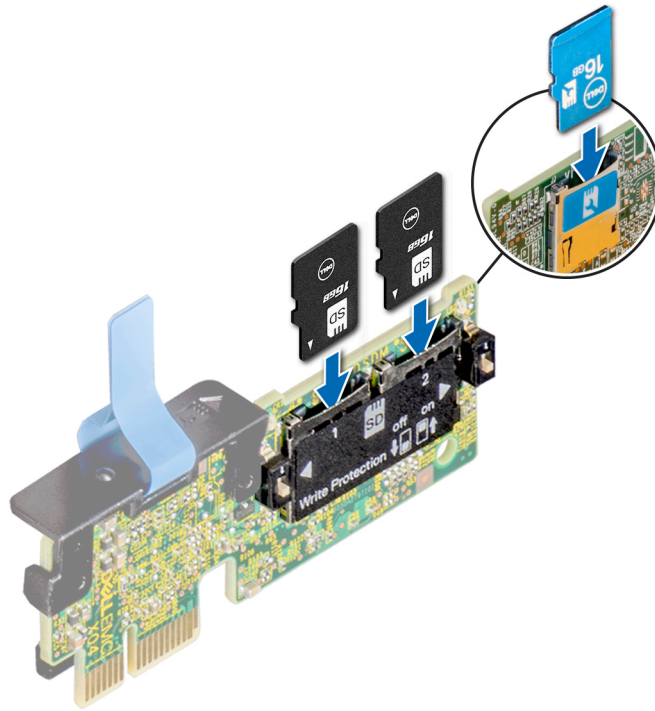

**Figure 72. Installing the MicroSD card**

### Next steps

Follow the procedure listed in [After working inside your system](#) on page 35.

## Network daughter card

### Removing the network daughter card

#### Prerequisites

1. Follow the safety guidelines listed in [Safety instructions](#) on page 34.
2. Follow the procedure listed in [After working inside your system](#) on page 35.
3. Remove the expansion card riser 2 or the rear drive cage, depending on the configuration of your system.

#### Steps

1. Using a Phillips #2 screwdriver, loosen the captive screws that secure the network daughter card (NDC) to the system board.
2. Hold the NDC by the edges on either side of the touch points, and lift to remove it from the connector on the system board.
3. Slide the NDC towards the front of the system until the Ethernet connectors are clear of the slot in the back panel.

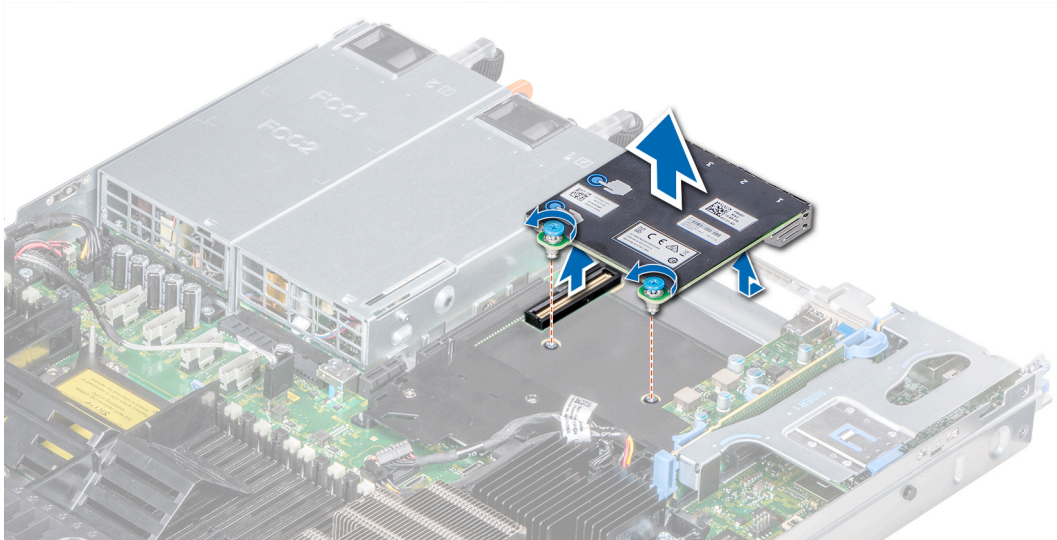

**Figure 73. Removing the network daughter card**

### Next steps

Install the Network Daughter Card.

## Installing the network daughter card

### Prerequisites

Follow the safety guidelines listed in [Safety instructions](#) on page 34.

### Steps

1. Orient the NDC so that the Ethernet connectors fit through the slot in the chassis.
2. Align the captive screws at the back-end of the card with the screw holes on the system board.
3. Press the touch points on the card until the card connector is firmly seated on the system board connector.
4. Using a Phillips #2 screwdriver, tighten the captive screws to secure the NDC to the system board.

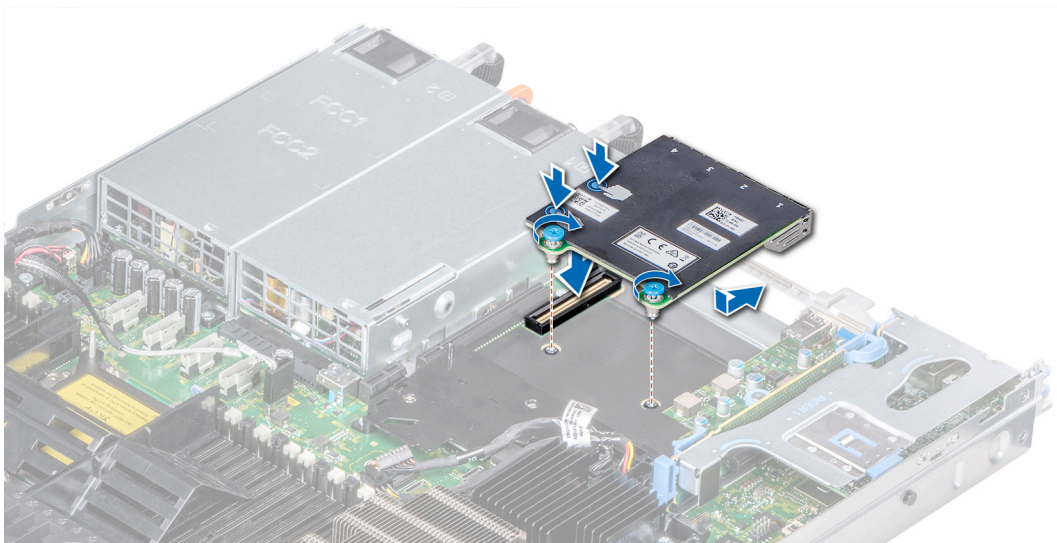

**Figure 74. Installing the network daughter card**

### Next steps

1. Install the expansion card riser 2 or the rear drive cage, depending on the configuration of your system.
2. Follow the procedure listed in [After working inside your system](#) on page 35.

## Integrated storage controller card

### Removing the integrated storage controller card

#### Prerequisites

1. Follow the safety guidelines listed in [Safety instructions](#) on page 34.
2. Follow the procedure listed in [After working inside your system](#) on page 35.
3. [Remove the air shroud](#).

#### Steps

1. Using Phillips #2 screwdriver, loosen the screws that secure the integrated storage controller cable to the connector on the system board.
2. Lift the integrated storage controller cable to disconnect it from the connector on the system board.

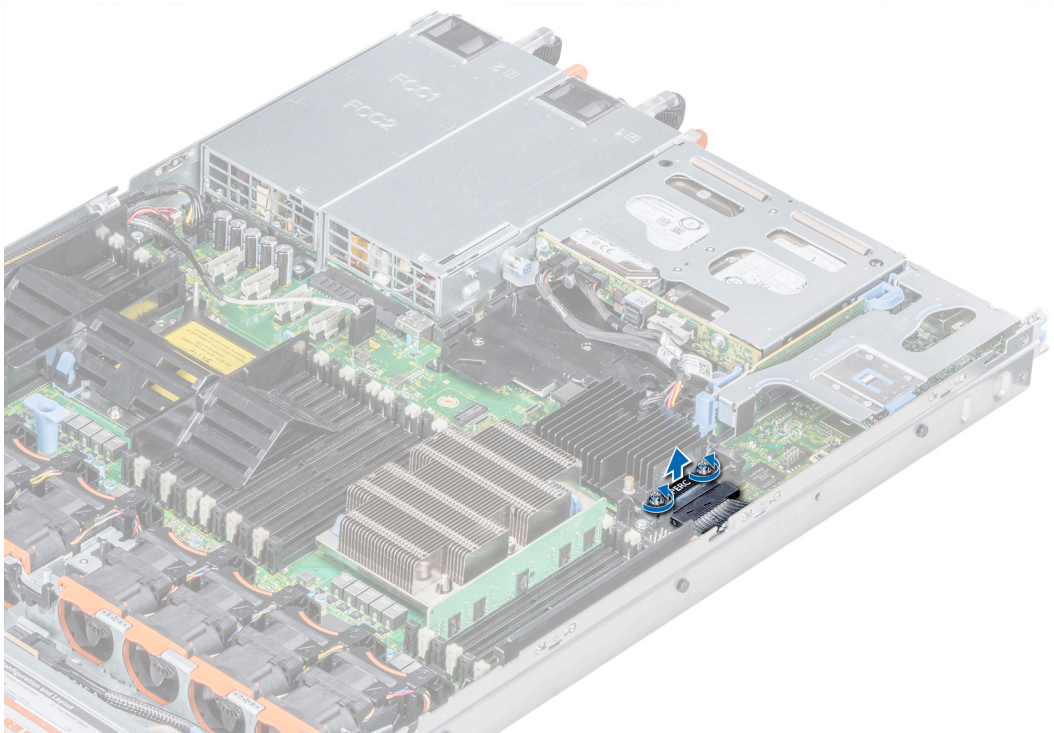

**Figure 75. Removing the integrated storage controller cable**

3. Lift one end of the card and angle it to disengage the card from the card holder on the system board.
4. Lift the card out of the system.

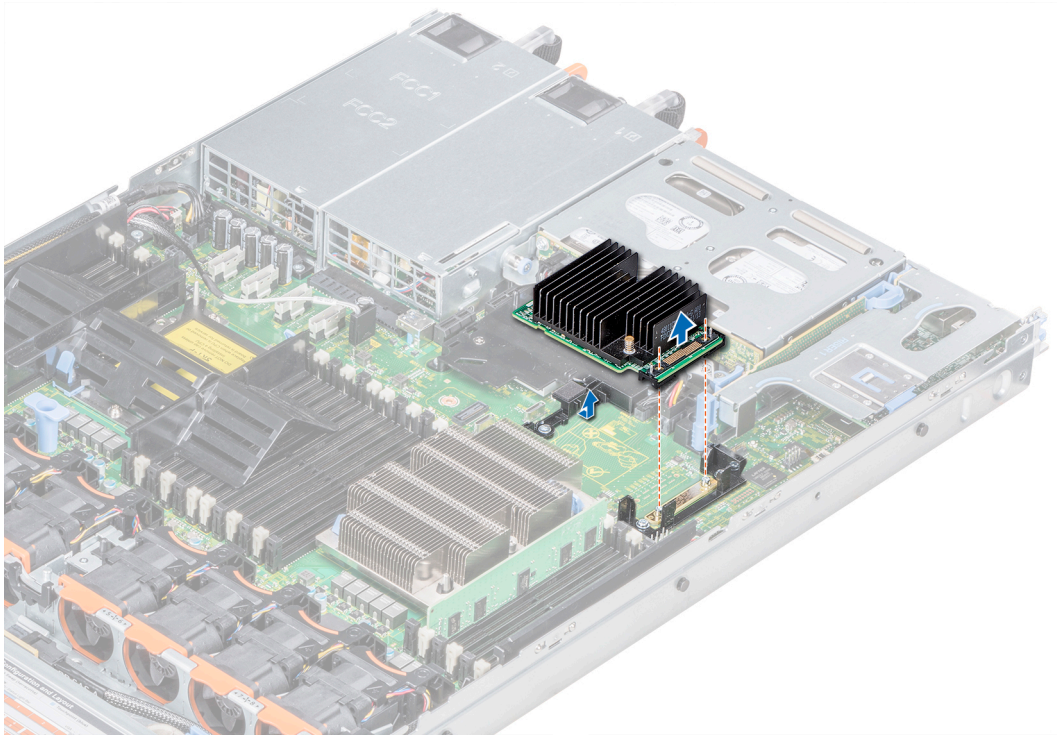

**Figure 76. Removing the integrated storage controller card**

#### Next steps

Install the integrated storage controller card.

## Installing the integrated storage controller card

#### Prerequisites

Follow the safety guidelines listed in [Safety instructions](#) on page 34.

#### Steps

1. Angle the integrated storage controller card and align the end of the card with the controller card connector on the system board.
2. Lower the connector side of the integrated storage controller card into the integrated storage controller card connector on the system board.

**NOTE:** Ensure that the slots on the system board align with the screw holes on the integrated storage controller card connector.

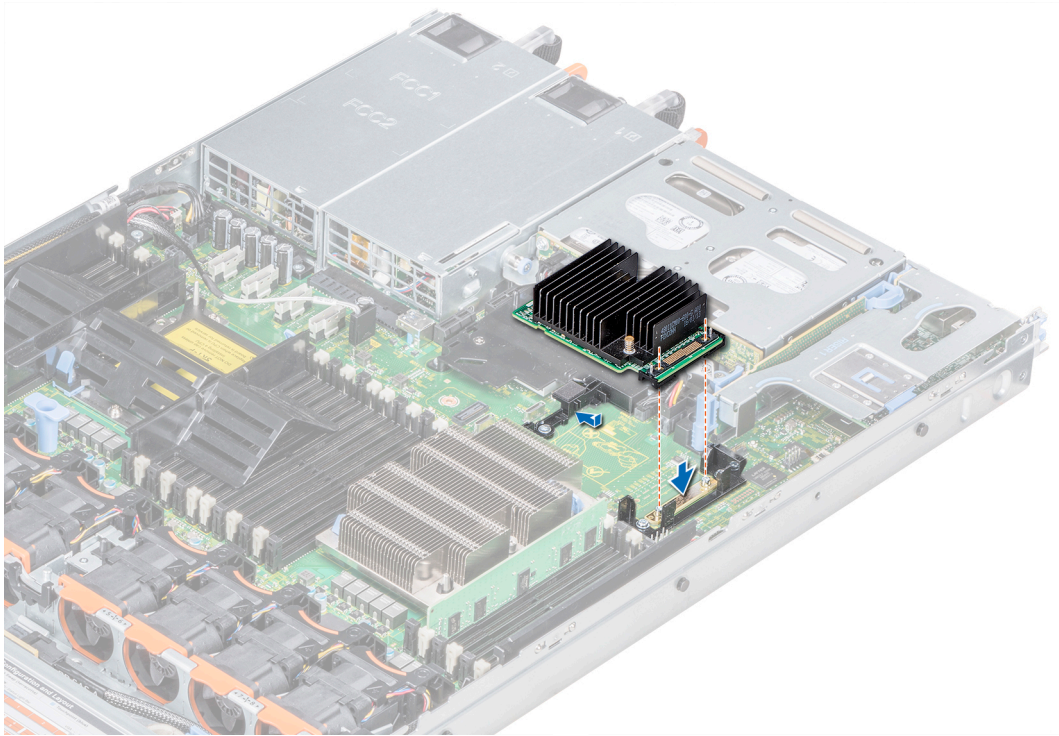

**Figure 77. Installing the integrated storage controller card**

3. Route the integrated storage controller card cable along the wall of the system.
4. Align the screws on the integrated storage controller card cable with the screw holes on the connector.
5. Using Phillips #2 screwdriver, tighten the screws to secure the integrated storage controller card cable to the card connector on the system board.

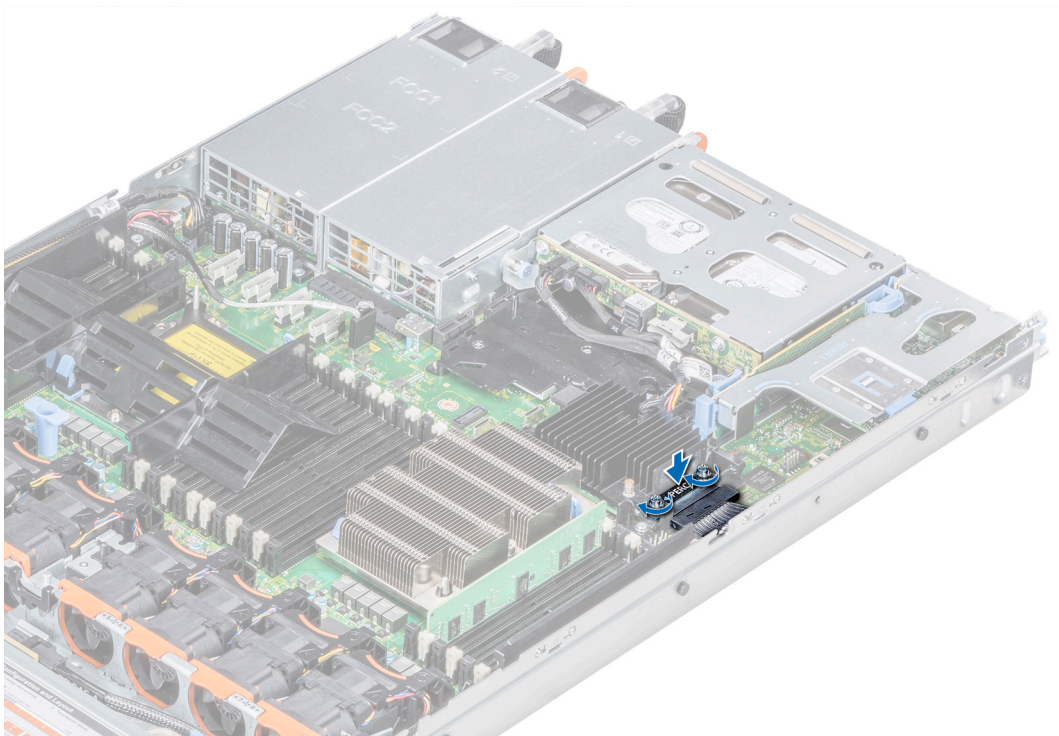

**Figure 78. Installing the integrated storage controller card cable**

**Next steps**

1. [Install the air shroud.](#)
2. Follow the procedure listed in [After working inside your system](#) on page 35.

# Backplane

## Backplane details

Depending on your system configuration, the drive backplanes supported in PowerEdge R640 are listed here:

**Table 32. Supported backplane options for PowerEdge R640 systems**

System	Supported drives options
PowerEdge R640	2.5 inch (x8) SAS or SATA backplane
	2.5 inch (x10) SAS, SATA, or NVMe backplane
	2.5 inch (x10) SAS, SATA, or NVMe backplane and 2.5 inch (x2) SAS or SATA backplane (back)
	3.5 inch (x4) SAS or SATA backplane

**NOTE:** Mixing of 2.5 inch 10K or 15K SAS drives with 2.5 inch 7.2K SATA or Nearline SAS drives on the same backplane is not supported. You can mix solid state drives with hard drives on the same backplane.

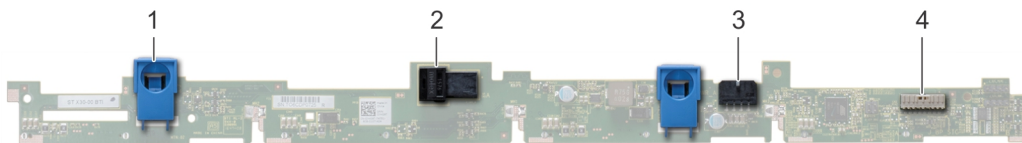

**Figure 79. 4 X 3.5 drive backplane**

1. release tab (2)
2. SAS cable A connector
3. SAS cable B connector
4. backplane signal cable connector

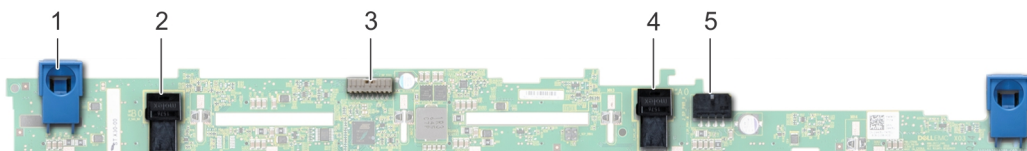

**Figure 80. 8 X 2.5 drive backplane**

1. release tab (2)
2. SAS cable A connector
3. backplane signal cable connector
4. backplane
5. SAS cable B connector
6. power cable connector

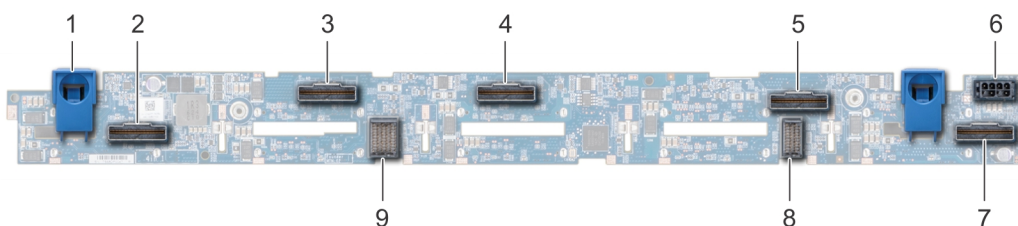

**Figure 81. 10 X 2.5 drive backplane**

1. release tab (2)
2. NVMe cable connector



- 3. NVMe cable connector
- 5. NVMe cable connector
- 7. NVMe cable connector
- 9. backplane to expander board cable connector
- 4. NVMe cable connector
- 6. power cable connector
- 8. backplane to expander board cable connector

## Removing the backplane cover

### Prerequisites

1. Follow the safety guidelines listed in [Safety instructions](#) on page 34.
2. Follow the procedure listed in [Before working inside your system](#) on page 35.
3. [Remove the system cover.](#)

### Steps

1. Slide the backplane cover in the direction of the arrows marked on the backplane cover.
2. Lift the backplane cover away from the system.

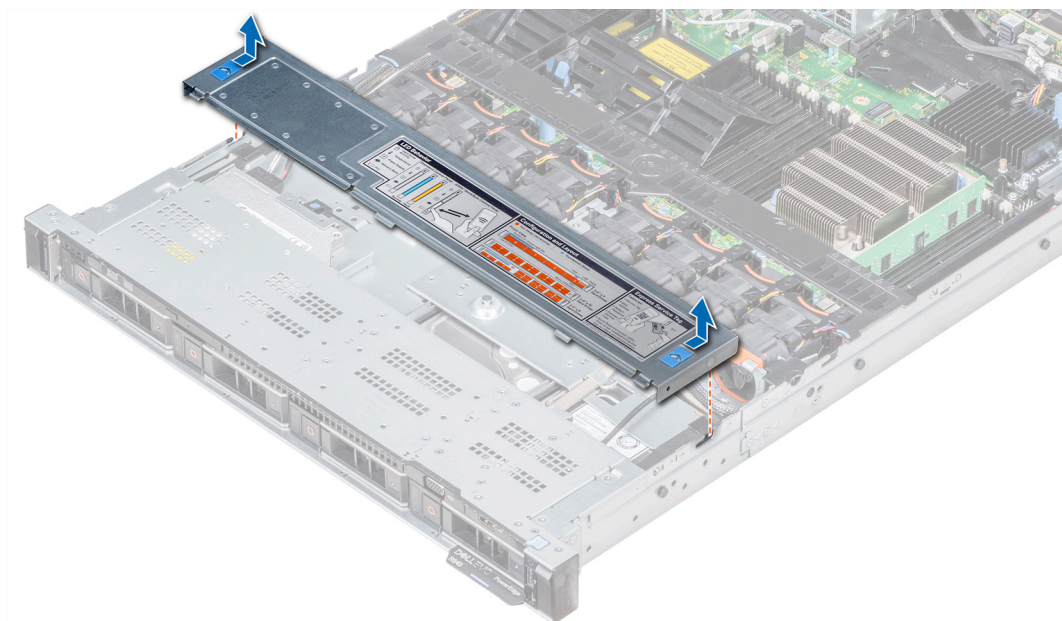

Figure 82. Removing the backplane cover

## Installing the backplane

### Prerequisites

Follow the safety guidelines listed in [Safety instructions](#) on page 34.

**NOTE:** The procedure to install the backplane is similar for all backplane configurations.

### Steps

1. Use the hooks on the system as guides to align the slots on the backplane with the guides on the system.
  2. Lower the drive backplane until the blue release tabs snap into place.
- NOTE:** If you are installing a backplane with an expander board, then tighten the captive screws after installing the backplane.

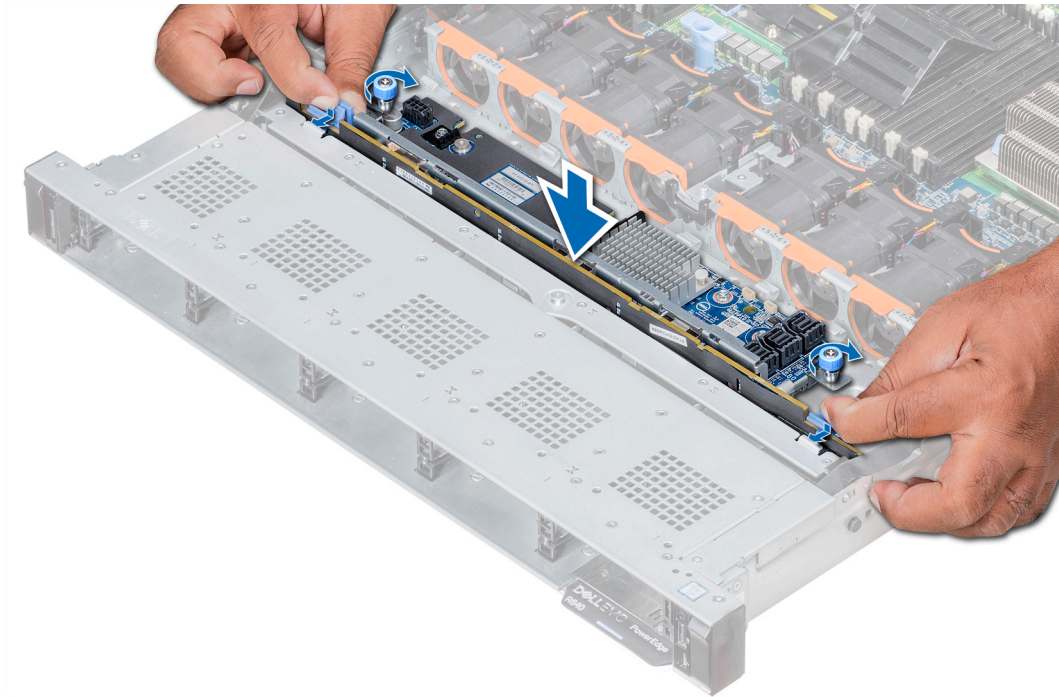

**Figure 83. Installing the backplane**

#### Next steps

1. Connect all the cables to the backplane.
2. Install all the drives.
3. Install the backplane cover.
4. [Install the air shroud.](#)
5. Follow the procedure listed in [After working inside your system](#) on page 35.

## Removing the 2.5 inch drive rear backplane

#### Prerequisites

**CAUTION:** To prevent damage to the drives and backplane, you must remove the drives from the system before removing the backplane.

**CAUTION:** You must note the number of each drive and temporarily label them before removal so that you can replace them in the same locations.

1. Follow the safety guidelines listed in [Safety instructions](#) on page 34.
2. Follow the procedure listed in [Before working inside your system](#) on page 35.
3. Remove all the drives from the rear drive cage.
4. Disconnect all the cables from the backplane.
5. [Remove the rear drive cage.](#)

#### Steps

1. Using Phillips #2 screwdriver, remove the screws that secure the drive backplane to the rear drive cage.
2. Disengage the backplane from the hooks on the rear drive cage, and remove it from the rear drive cage.

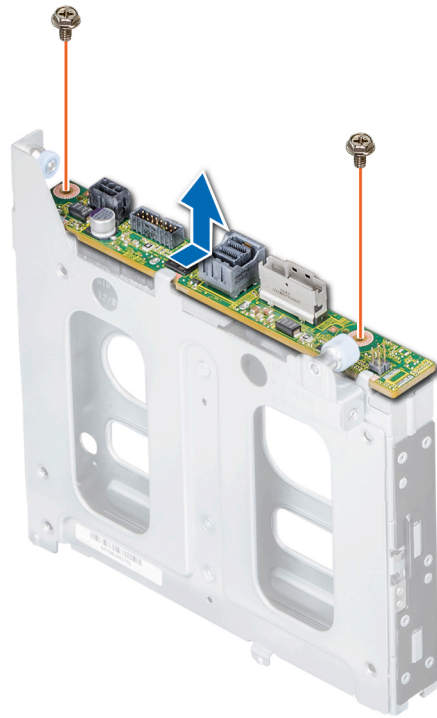

**Figure 84. Removing the 2.5 inch drive rear backplane**

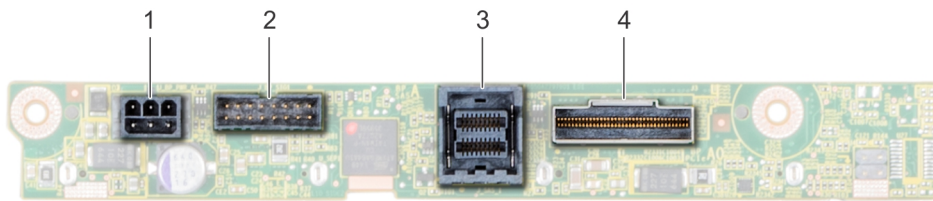

**Figure 85. 2 X 2.5 rear drive backplane**

- |                        |                               |
|------------------------|-------------------------------|
| 1. power connector     | 2. backplane signal connector |
| 3. SAS cable connector | 4. NVMe cable connector       |

**Next steps**

Install the 2.5 inch drive rear backplane.

## Installing the 2.5 inch drive rear backplane

**Prerequisites**

Follow the safety guidelines listed in [Safety instructions](#) on page 34.

**Steps**

1. Use the hooks on the rear drive cage as guides to align the drive backplane.
2. Lower the backplane into the system until it is firmly seated.
3. Using Phillips #2 screwdriver, replace the screws to secure the backplane to the rear drive cage.

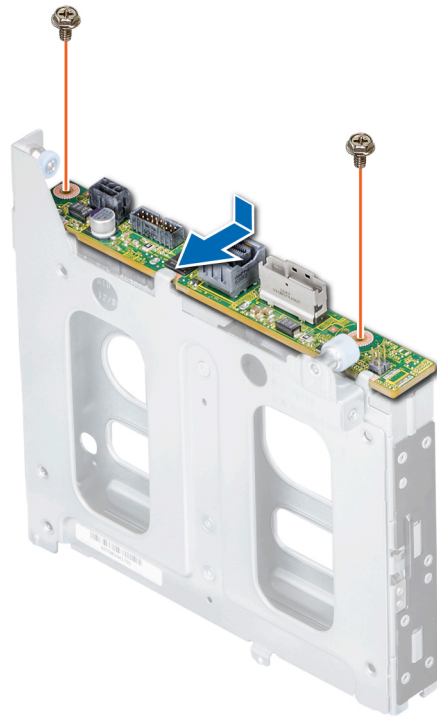
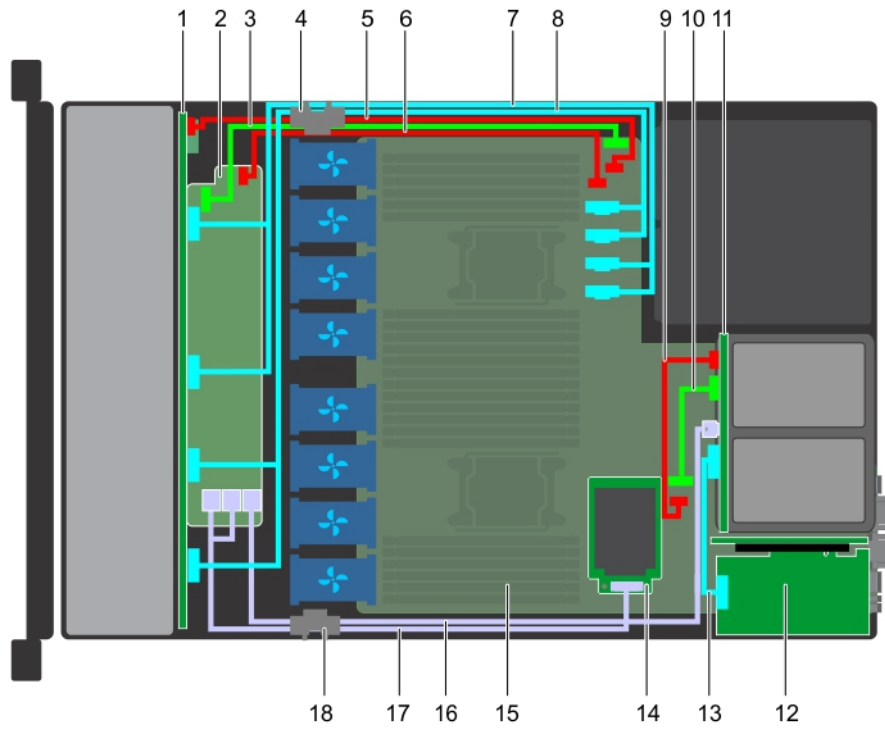

**Figure 86. Installing the 2.5 inch drive rear backplane**

**Next steps**

1. [Install the rear drive cage.](#)
2. Install all the drives.
3. Connect all the cables to the backplane.
4. Follow the procedure listed in [Before working inside your system](#) on page 35.

# Cable routing



**Figure 87. Cable routing - 10 x 2.5 drive backplane and 2 x 2.5 rear drive backplane with mini PERC**

- |   |   |
|---|---|
| 1. Backplane  | 2. Backplane expander   |
| 3. Backplane signal cable (BP: J_BP_SIG to MB: J_BP_SIG1)           | 4. Cable routing clip   |
| 5. Backplane power cable(BP: J_BP_PWR_A1 to MB: J_BP1)              | 6. Backplane expander power cable                                     |
| 7. NVMe cable (BP PCIe B1 and BP PCIe A1)                           | 8. NVMe cable (BP PCIe B0 and BP PCIe A0)                             |
| 9. Rear backplane power cable(Rear BP: J_BP_BPO to MB: J_BP_PWR_A1) | 10. Rear backplane signal cable (Rear BP: J_BP_SIG0 to MB: J_BP_SIG1) |
| 11. Rear backplane  | 12. PCIe expansion card   |
| 13. PCIe cable  | 14. Mini PERC card  |
| 15. System board  | 16. SAS cable (BP: MiniSAS HD A2 to MB: J_SAS_1)                      |
| 17. SAS cable (BP: BP SAS A0, BP SAS B0 to MP: J_STORAGE1)          | 18. Cable routing clip  |

**NOTE:** The internal cable connectors are not hot-pluggable.

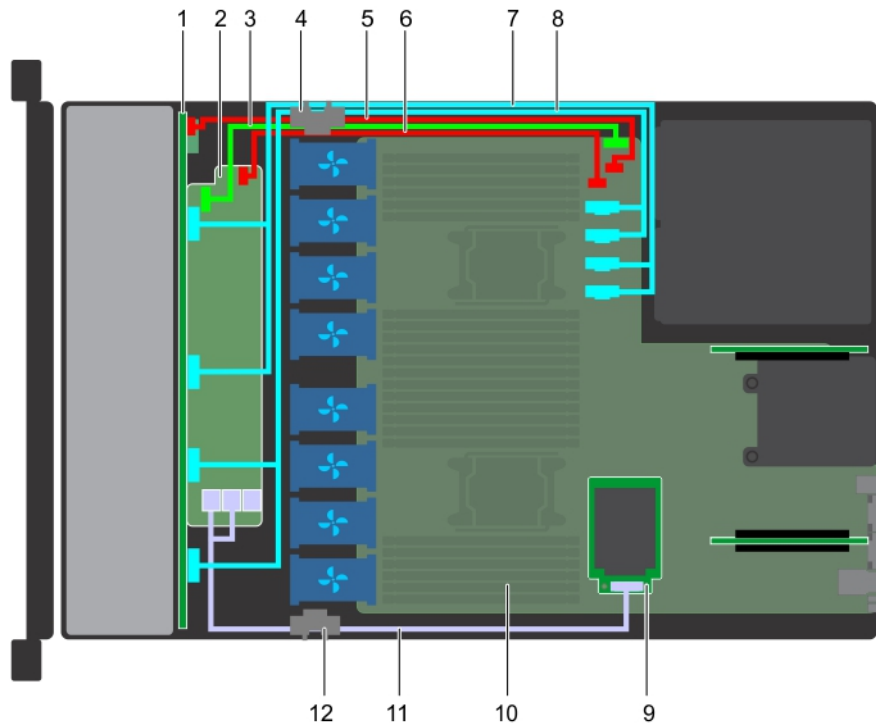

**Figure 88. Cable routing - 10 x 2.5 drive backplane with mini PERC**

- |   |  |
|---|--|
| 1. Backplane  | 2. Backplane expander  |
| 3. Backplane signal cable (BP: J_BP_SIG to MB: J_BP_SIG1) | 4. Cable routing clip  |
| 5. Backplane power cable(BP: J_BP_PWR_A1 to MB: J_BP1)    | 6. Backplane expander power cable(BP: J_BP_PWR_A to MB: J_BP1) |
| 7. NVMe cable (BP PCIe B1 and BP PCIe A1)                 | 8. NVMe cable (BP PCIe B0 and BP PCIe A0)                      |
| 9. Mini PERC card   | 10. System board   |
| 11. SAS cable(BP: BP SAS A0, BP SAS B0 to MP: J_STORAGE1) | 12. Cable routing clip   |

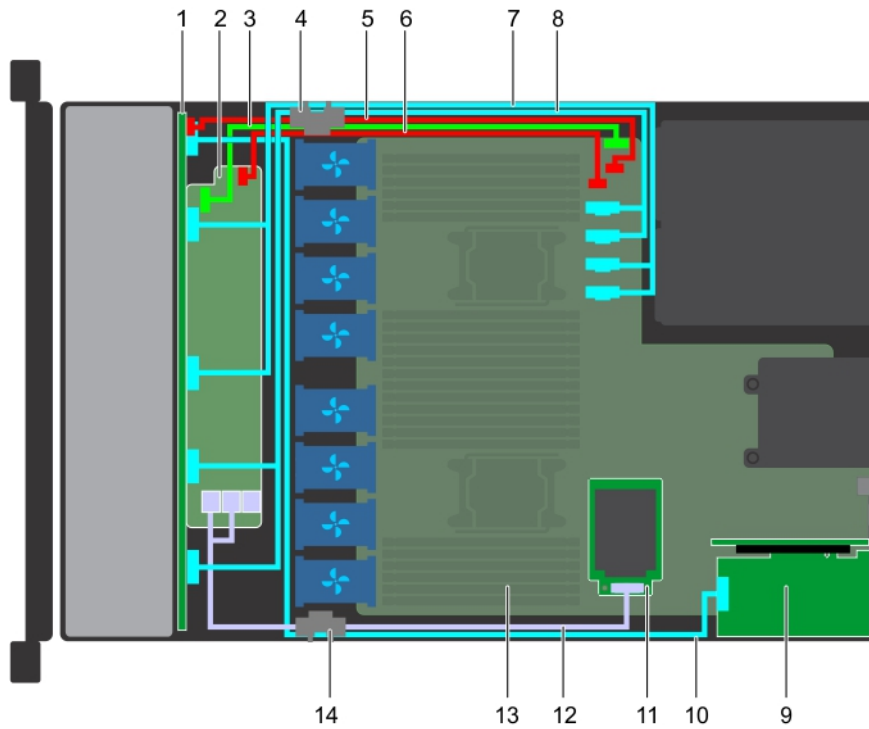

**Figure 89. Cable routing - 10 x 2.5 drive backplane with NVMe**

- |   |   |
|---|---|
| 1. Backplane  | 2. Backplane expander   |
| 3. Backplane signal cable (BP: J_BP_SIG to MB: J_BP_SIG1) | 4. Cable routing clip   |
| 5. Backplane power cable (BP: J_BP_PWR_A1 to MB: J_BP1)   | 6. Backplane expander power cable (BP: J_BP_PWR_A to MB: J_BP1) |
| 7. NVMe cable (BP PCIe B1 and BP PCIe A1)                 | 8. NVMe cable (BP PCIe B0 and BP PCIe A0)                       |
| 9. PCIe expansion card                                    | 10. NVMe signal cable (PCIe card to BP PCIe A2)                 |
| 11. Mini PERC card  | 12. SAS cable (BP: BP SAS A0, BP SAS B0 to MP: J_STORAGE1)      |
| 13. System board  | 14. Cable routing clip  |

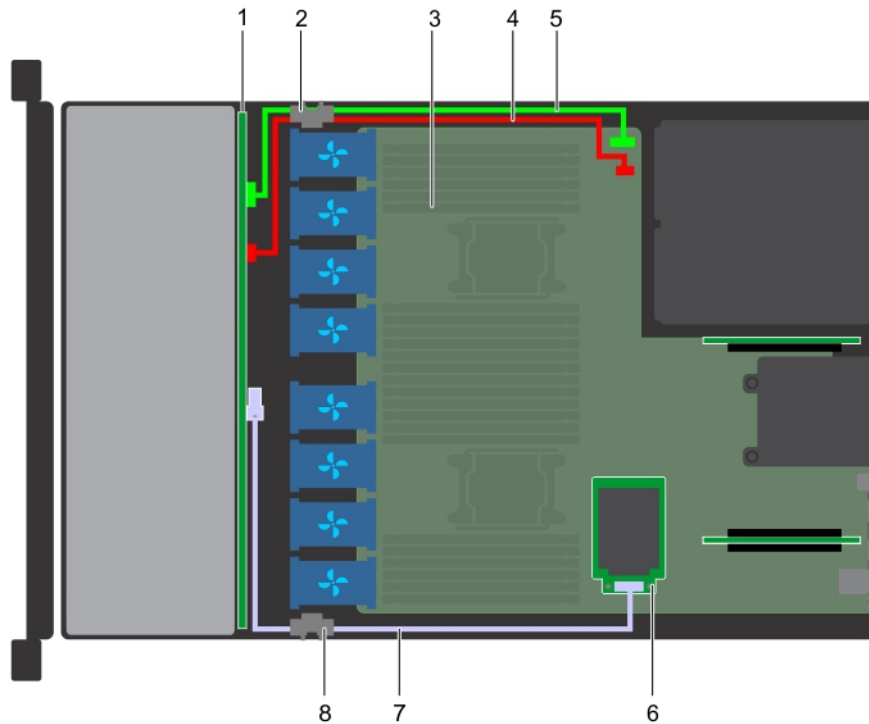

**Figure 90. Cable routing - 4 x 3.5 drive backplane with mini PERC**

- |  |   |
|--|---|
| 1. Drive backplane                                       | 2. Cable routing clip                                   |
| 3. System board  | 4. Backplane power cable(BP: J_BP_SIG to MB: J_BP_SIG1) |
| 5. Backplane signal cable(BP: J_BP_SIG to MB: J_BP_SIG1) | 6. Mini PERC card                                       |
| 7. SAS cable(BP: J_SAS_A to MB: J_STORAGE1)              | 8. Cable routing clip                                   |

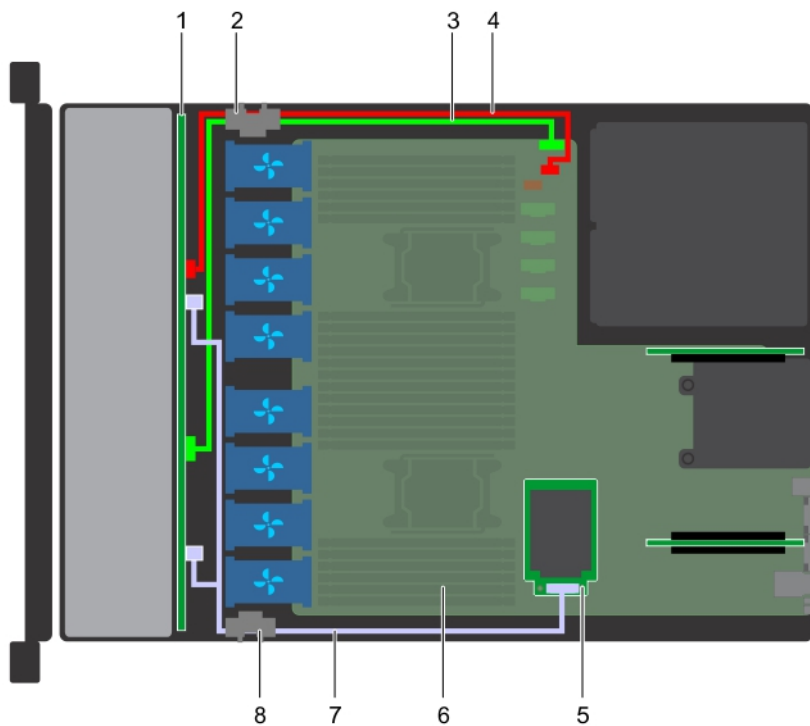

**Figure 91. Cable routing - 8 x 2.5 drive backplane with mini PERC**

- |  |  |
|--|--|
| 1. Drive backplane                                       | 2. Cable routing clip                                  |
| 3. Backplane signal cable(BP: J_BP_SIG to MB: J_BP_SIG1) | 4. Backplane power cable(BP: J_BP_PWR_A1 to MB: J_BP1) |
| 5. Mini PERC card  | 6. System board  |



7. SAS cable(BP: J\_SAS\_A to MP: J\_STORAGE1)

8. Cable routing clip

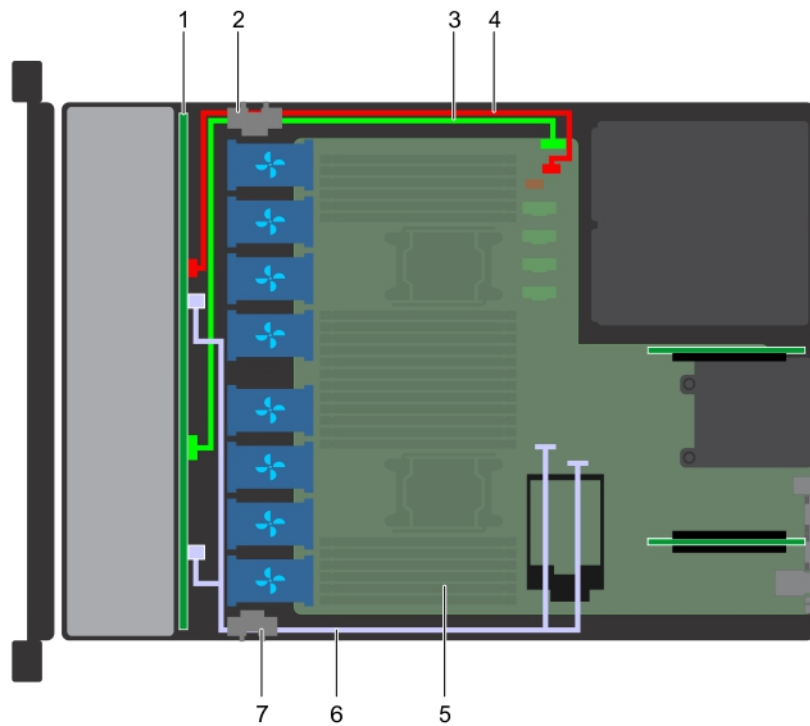

**Figure 92. Cable routing - 8 x 2.5 drive backplane with onboard SATA**

1. Drive backplane
2. Cable routing clip
3. Backplane signal cable(BP: J\_BP\_SIG to MB: J\_BP\_SIG1)
4. Backplane power cable(BP: J\_BP\_PWR\_A1 to MB: J\_BP1)
5. System board
6. SATA cable(BP: J\_SAS\_A0, J\_SAS\_B0 to MB: SATA\_A, SATA\_B)
7. Cable routing clip

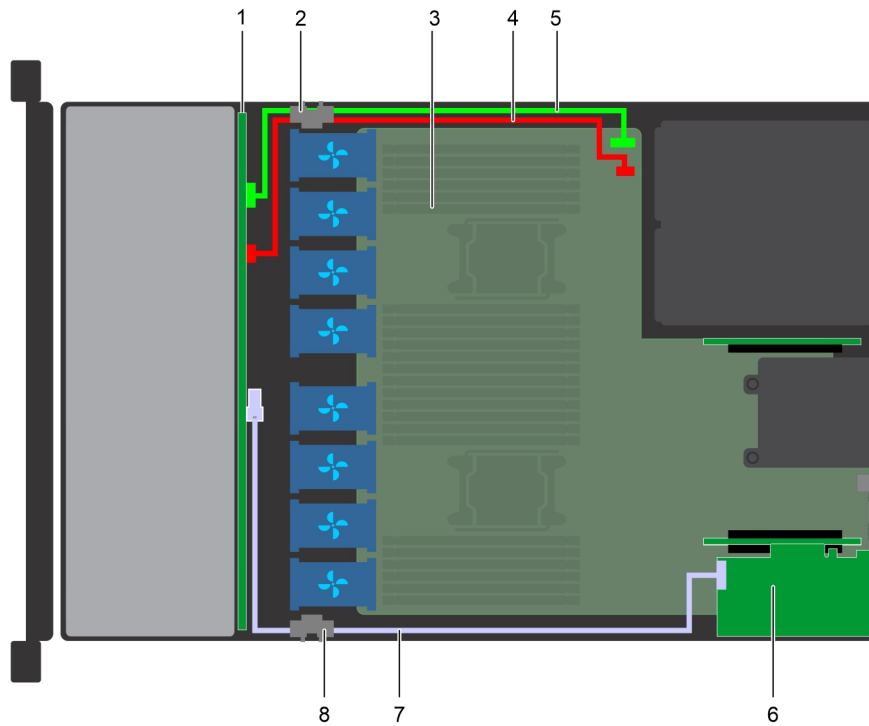

**Figure 93. Cable routing - 4 x 3.5 drive backplane with adapter PERC**

- |  |   |
|--|---|
| 1. Drive backplane                                       | 2. Cable routing clip                                   |
| 3. System board  | 4. Backplane power cable(BP: J_BP_SIG to MB: J_BP_SIG1) |
| 5. Backplane signal cable(BP: J_BP_SIG to MB: J_BP_SIG1) | 6. Adapter PERC card (PERC11)                           |
| 7. SAS cable(BP: J_SAS_A to PERC: A1)                    | 8. Cable routing clip                                   |

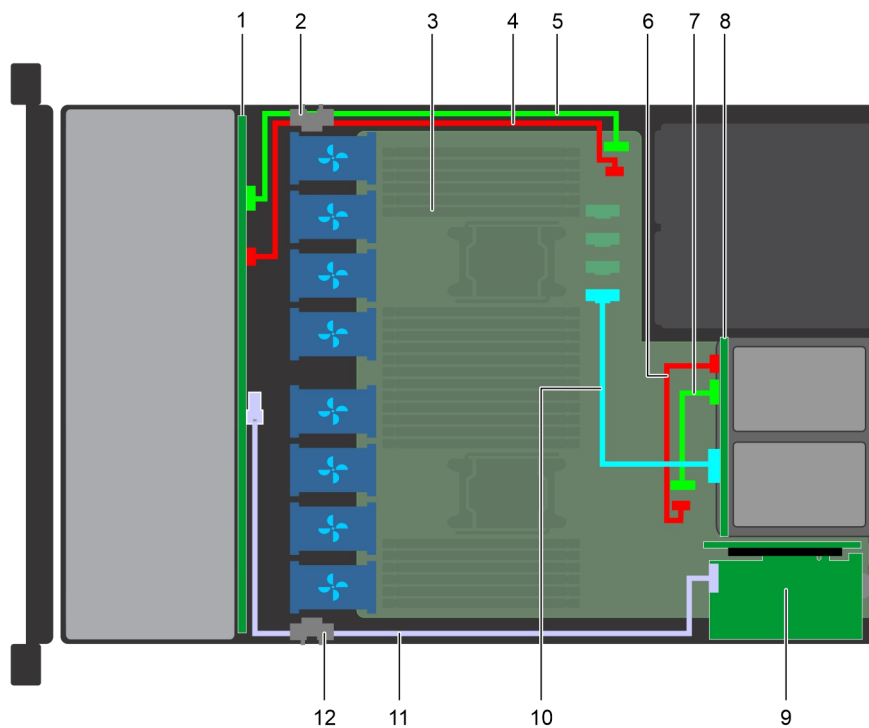

**Figure 94. Cable routing - 4 x 3.5 drive backplane and 2 x 2.5 rear drive backplane with NVMe**

- |                    |   |
|--------------------|---|
| 1. Drive backplane | 2. Cable routing clip                                   |
| 3. System board    | 4. Backplane power cable(BP: J_BP_SIG to MB: J_BP_SIG1) |

- 5. Backplane signal cable(BP: J\_BP\_SIG to MB: J\_BP\_SIG1)
- 6. Rear backplane power cable(Rear BP: J\_BP\_BPO to MB:J\_BP\_PWR\_A1)
- 7. Rear backplane signal cable (Rear BP: J\_BP\_SIG0 to MB: J\_BP\_SIG1)
- 8. Rear backplane
- 9. Adapter PERC card (PERC11)
- 10. PCIe cable
- 11. SAS cable(BP: J\_SAS\_A to PERC: A1)
- 12. Cable routing clip

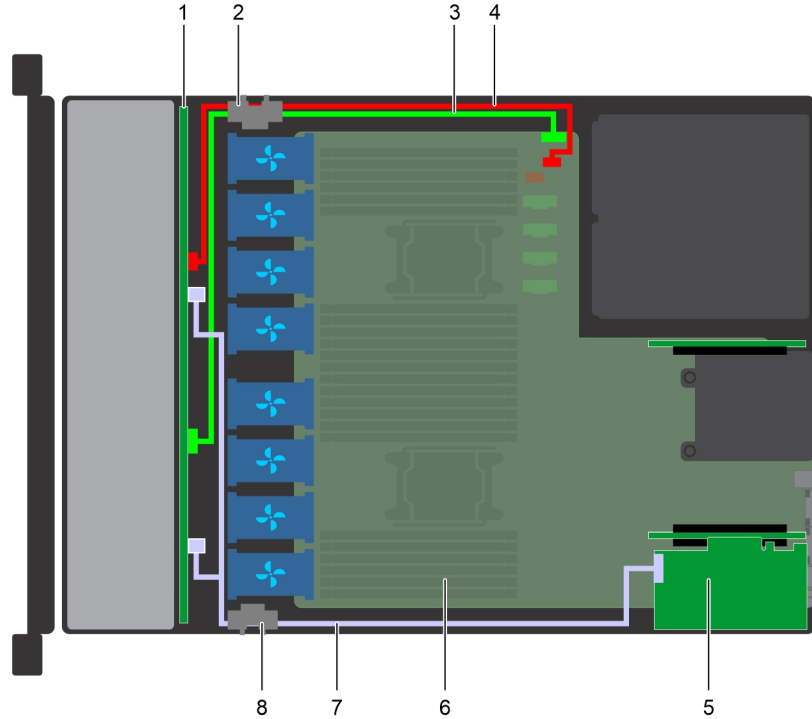

**Figure 95. Cable routing - 8 x 2.5 drive backplane with adapter PERC**

- 1. Drive backplane
- 2. Cable routing clip
- 3. Backplane signal cable(BP: J\_BP\_SIG to MB: J\_BP\_SIG1)
- 4. Backplane power cable(BP: J\_BP\_PWR\_A1 to MB: J\_BP1)
- 5. Adapter PERC card (PERC11)
- 6. System board
- 7. SAS cable(BP: J\_SAS\_A0, J\_SAS\_B0 to PERC: A1)
- 8. Cable routing clip

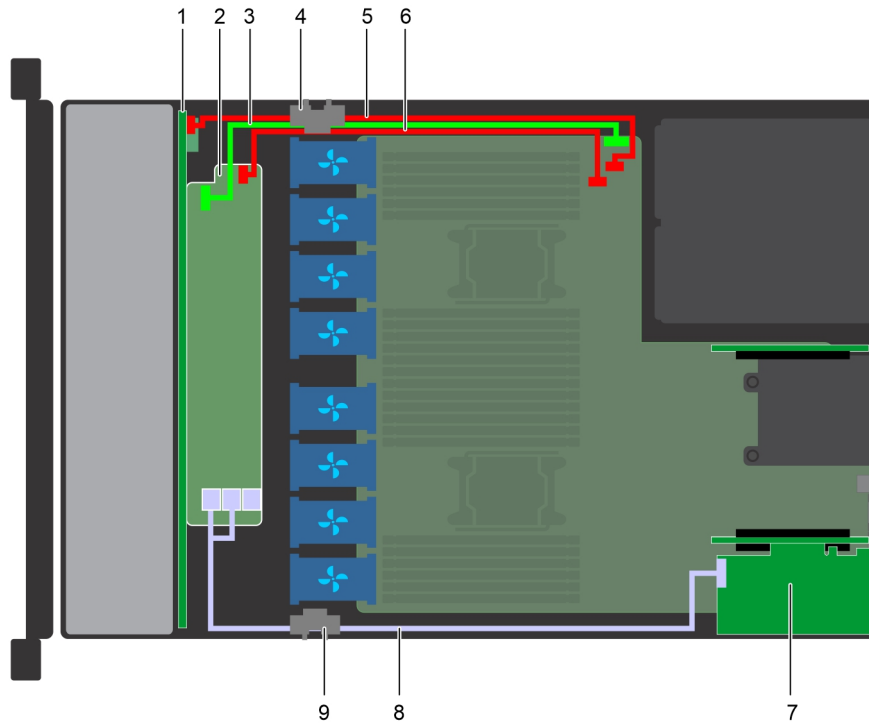

**Figure 96. Cable routing - 10 x 2.5 drive backplane with adapter PERC**

- |   |   |
|---|---|
| 1. Backplane  | 2. Backplane expander   |
| 3. Backplane signal cable (BP: J_BP_SIG to MB: J_BP_SIG1) | 4. Cable routing clip   |
| 5. Backplane power cable (BP: J_BP_PWR_A1 to MB: J_BP1)   | 6. Backplane expander power cable (BP: J_BP_PWR_A to MB: J_BP1) |
| 7. Adapter PERC card (PERC11)                             | 8. SAS cable (BP: BP SAS A0, BP SAS B0 to PERC: A1)             |
| 9. Cable routing clip                                     |   |

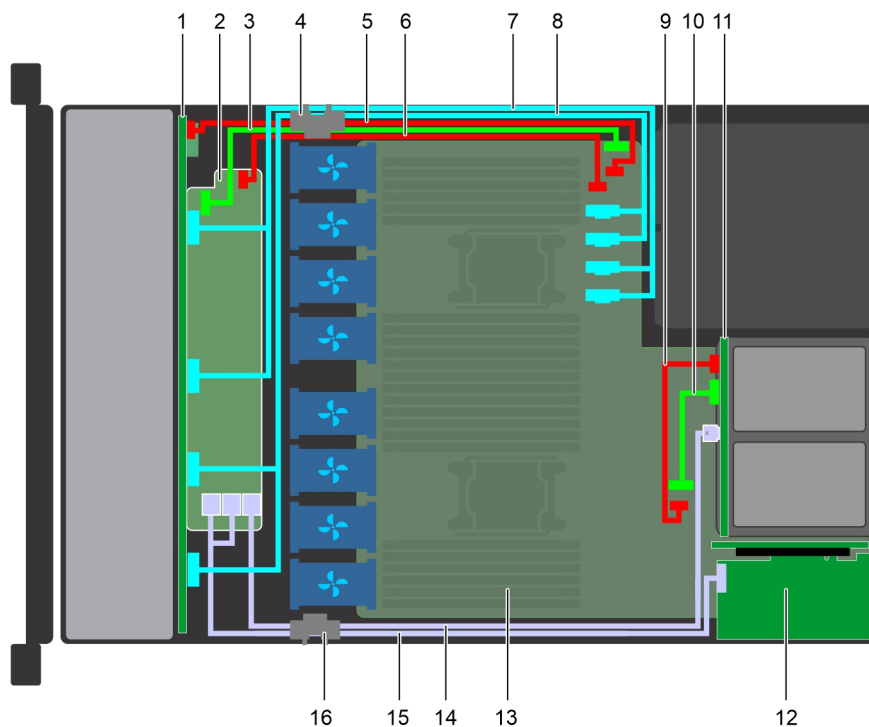

**Figure 97. Cable routing - 10 x 2.5 drive backplane and 2 x 2.5 rear drive backplane with onboard SATA**

- |              |                       |
|--------------|-----------------------|
| 1. Backplane | 2. Backplane expander |
|--------------|-----------------------|

- 3. Backplane signal cable (BP: J\_BP\_SIG to MB: J\_BP\_SIG1)
- 4. Cable routing clip
- 5. Backplane power cable (BP: J\_BP\_PWR\_A1 to MB: J\_BP1)
- 6. Backplane expander power cable
- 7. NVMe cable (BP PCIe B1 and BP PCIe A1)
- 8. NVMe cable (BP PCIe B0 and BP PCIe A0)
- 9. Rear backplane power cable (Rear BP: J\_BP\_BPO to MB: J\_BP\_PWR\_A1)
- 10. Rear backplane signal cable (Rear BP: J\_BP\_SIG0 to MB: J\_BP\_SIG1)
- 11. Rear backplane
- 12. Adapter PERC card (PERC11)
- 13. System board
- 14. SAS cable (BP: MiniSAS HD A2 to rear BP: J\_SAS\_1)
- 15. SAS cable (BP: BP SAS A0, BP SAS B0 to PERC: A1)
- 16. Cable routing clip

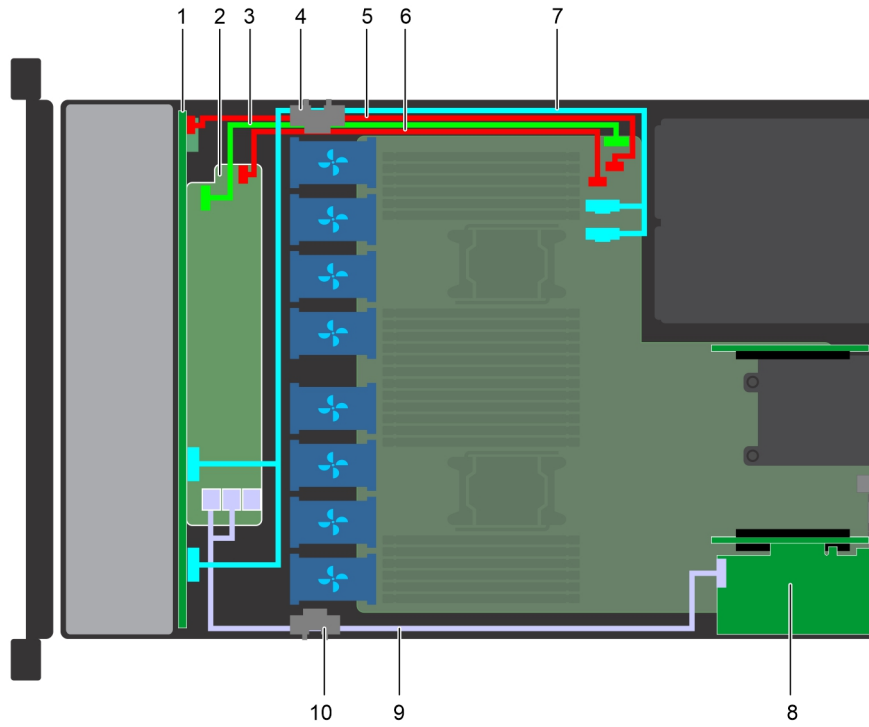

**Figure 98. Cable routing -10 x 2.5 drive backplane with 4 NVMe**

- 1. Backplane
- 2. Backplane expander
- 3. Backplane signal cable (BP: J\_BP\_SIG to MB: J\_BP\_SIG1)
- 4. Cable routing clip
- 5. Backplane power cable (BP: J\_BP\_PWR\_A1 to MB: J\_BP1)
- 6. Backplane expander power cable (BP: J\_BP\_PWR\_A to MB: J\_BP1)
- 7. NVMe cable (BP PCIe B0 and BP PCIe A0)
- 8. Adapter PERC card (PERC11)
- 9. SAS cable (BP: BP SAS A0, BP SAS B0 to PERC: A1)
- 10. Cable routing clip

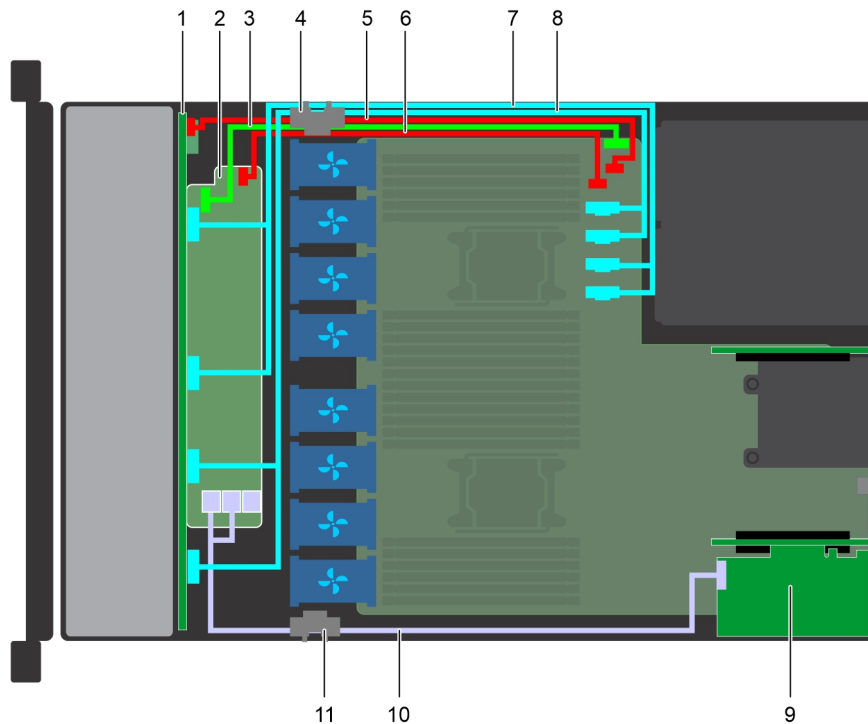

**Figure 99. Cable routing -10 x 2.5 drive backplane with 8 NVMe**

- |   |   |
|---|---|
| 1. Backplane  | 2. Backplane expander   |
| 3. Backplane signal cable (BP: J_BP_SIG to MB: J_BP_SIG1) | 4. Cable routing clip   |
| 5. Backplane power cable (BP: J_BP_PWR_A1 to MB: J_BP1)   | 6. Backplane expander power cable (BP: J_BP_PWR_A to MB: J_BP1) |
| 7. NVMe cable (BP PCIe B1 and BP PCIe A1)                 | 8. NVMe cable (BP PCIe B0 and BP PCIe A0)                       |
| 9. Adapter PERC card (PERC11)                             | 10. SAS cable (BP: BP SAS A0, BP SAS B0 to PERC: A1)            |
| 11. Cable routing clip                                    |   |

**NOTE:** The PERC11 H750, H350 and HBA350i cards are not supported on 4x3.5 + 2x2.5 dual PERC, 10x2.5 + 2x2.5 dual PERC, or x10 NVMe configurations.

## SAS expander card

### Removing the SAS expander card

#### Prerequisites

1. Follow the safety guidelines listed in [Safety instructions](#) on page 34.
2. Follow the procedure listed in [Before working inside your system](#) on page 35.
3. [Remove the cooling shroud.](#)
4. Remove the cooling fan assembly.
5. [Remove the backplane cover.](#)
6. Disconnect the SAS cables from the SAS expander card.

#### Steps

1. Using Philips #2 screwdriver, loosen the screws that secure the SAS expander card to the expander card tray.
2. Pull the SAS expander card to disengage the connectors on SAS expander from the SAS connectors on backplane.

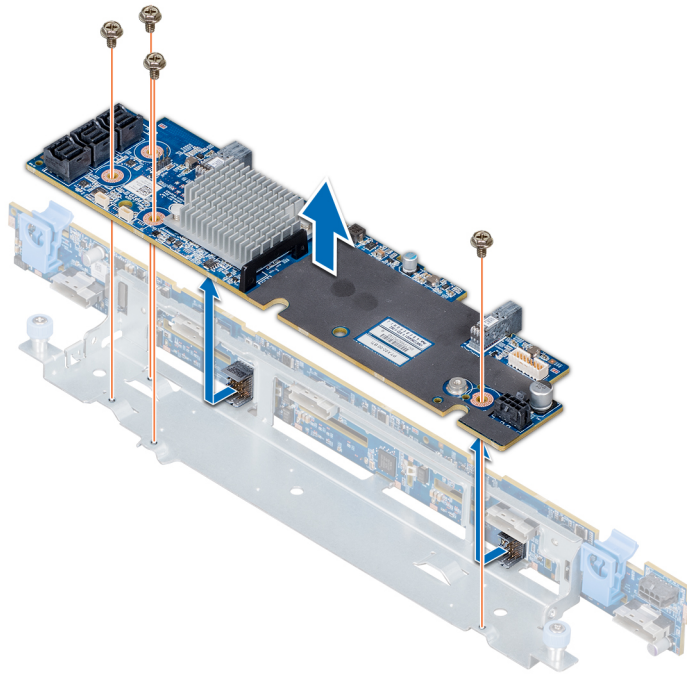

**Figure 100. Removing the SAS expander card**

### **Next steps**

Install the SAS expander card.

## **Installing the SAS expander card**

### **Prerequisites**

Follow the safety guidelines listed in [Safety instructions](#) on page 34.

### **Steps**

1. Align the slots on the SAS expander card with the standoffs on the expander card tray.
2. Slide the SAS expansion card until the connectors on the SAS expander card engage with the SAS connectors on the backplane.
3. Using Philips #2 screwdriver, tighten the screws to secure the SAS expander card to the expander card tray.

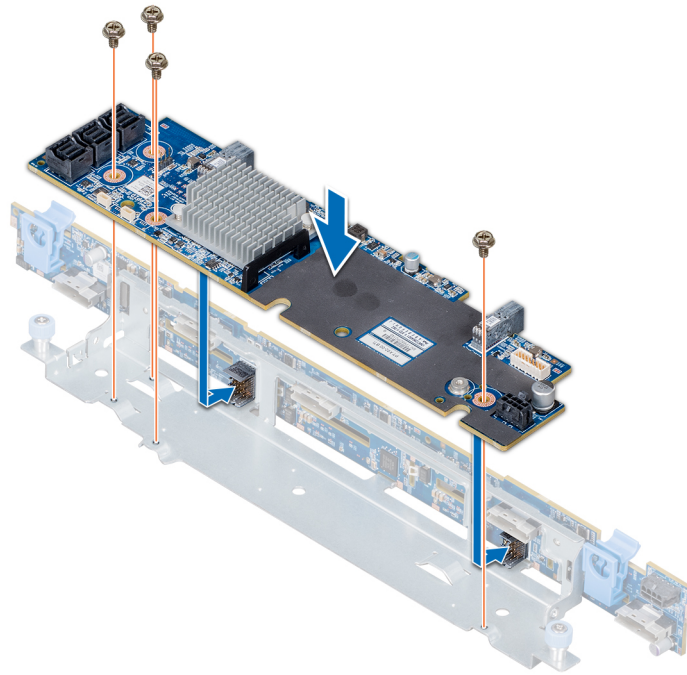

**Figure 101. Installing the SAS expander card**

#### **Next steps**

1. Connect the SAS cables to the SAS expander card.
2. [Install the backplane cover.](#)
3. Install the cooling fan assembly.
4. [Install the cooling shroud.](#)
5. Follow the procedure listed in [After working inside your system](#) on page 35.

## **Rear drive cage**

### **Removing the rear drive cage**

#### **Prerequisites**

1. Follow the safety guidelines listed in [Safety instructions](#) on page 34.
2. Follow the procedure listed in [Before working inside your system](#) on page 35.
3. Remove all the drives.
4. Disconnect all the cables from the rear drive backplane.

#### **Steps**

1. Using Phillips #2 screwdriver, loosen the screws that secure the drive cage to the system.
2. Pull and hold the screws to lift the drive cage away from the system.



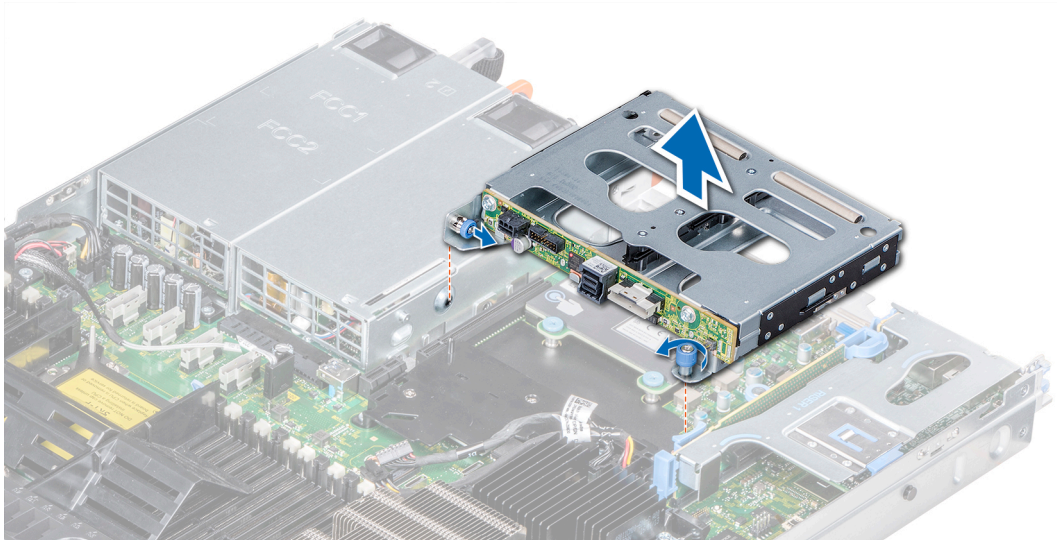

**Figure 102. Removing the rear drive cage**

### Next steps

Install the rear drive cage.

## Installing the rear drive cage

### Prerequisites

Follow the safety guidelines listed in [Safety instructions](#) on page 34.

### Steps

1. Align the screws on the drive cage with the screw holes on the system chassis.
2. Lower the drive cage into the system until it is firmly seated and the screws lock into place.
3. Using Phillips #2 screwdriver, tighten the screws.

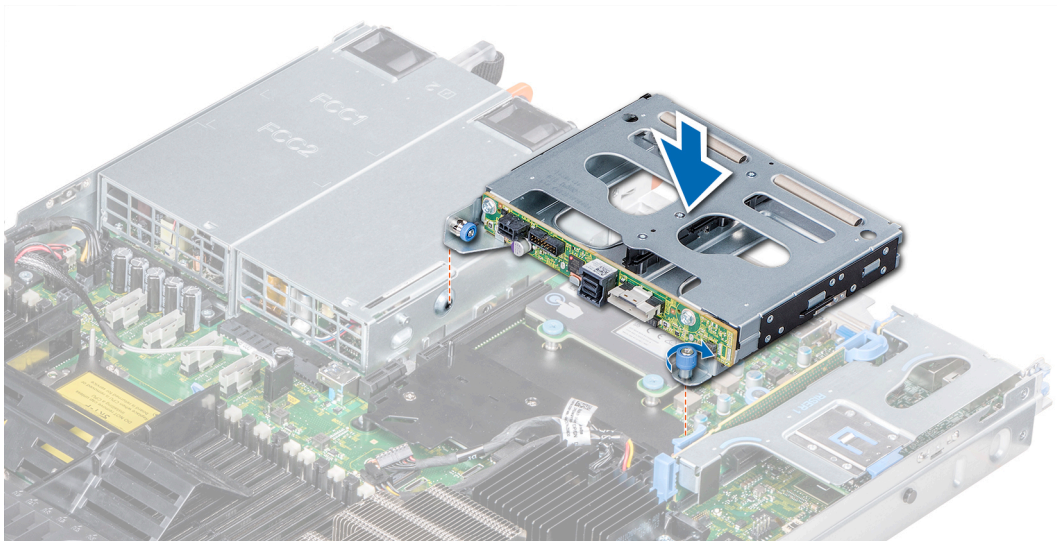

**Figure 103. Installing the rear drive cage**

### Next steps

1. Reconnect all the disconnected cables to the rear drive backplane.
2. Install all the drives.
3. Follow the procedure listed in [After working inside your system](#) on page 35.

## System battery

### Replacing the system battery

#### Prerequisites

**⚠ WARNING:** There is a danger of a new battery exploding if it is incorrectly installed. Replace the battery only with the same or equivalent type recommended by the manufacturer. For more information, see the safety information that shipped with your system.

1. Follow the safety guidelines listed in [Safety instructions](#) on page 34.
2. Follow the procedure listed in [Before working inside your system](#) on page 35.
3. If applicable, disconnect the power or data cables from expansion card(s) in the expansion card riser 1A.
4. [Remove the low profile or full height X1 expansion card riser 1A.](#)

#### Steps

1. Locate the battery socket. For more information, see the [System board jumpers and connectors](#) section.

**⚠ CAUTION:** To avoid damage to the battery connector, you must firmly support the connector while installing or removing a battery.

2. Use a plastic scribe to pry out the system battery.

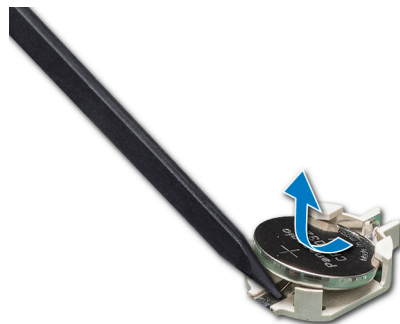

**Figure 104. Removing the system battery**

3. To install a new system battery, hold the battery with the positive side facing up and slide it under the securing tabs.
4. Press the battery into the connector until it snaps into place.



**Figure 105. Installing the system battery**

### Next steps

1. [Install the expansion card riser 1A.](#)
2. If applicable, connect the cables to the expansion card(s) in the expansion card riser 1A.

3. Follow the procedure listed in [After working inside your system](#) on page 35.
4. While booting, press F2 to enter the System Setup and ensure that the battery is operating properly.
5. Enter the correct time and date in the System Setup **Time** and **Date** fields.
6. Exit the System Setup.

## USB module

### Removing the USB module

#### Prerequisites

1. Follow the safety guidelines listed in [Safety instructions](#) on page 34.
2. Follow the procedure listed in [Before working inside your system](#) on page 35.
3. [Remove the backplane cover](#).
4. [Remove the air shroud](#).

**i** **NOTE:** Ensure that you note the routing of the cables as you remove them from the system board. Route these cables properly when you replace them to prevent them from being pinched or crimped.

**i** **NOTE:** The procedure to remove the USB 3.0 and USB 2.0 modules is similar.

#### Steps

1. Disconnect the USB cable from the USB connector on the system board. For more information, see the System board jumpers and connectors section.
2. Using Phillips #1 screwdriver, remove the screws on the USB module.
3. Slide the module out of the system until it is free of the USB module slot on the front panel.

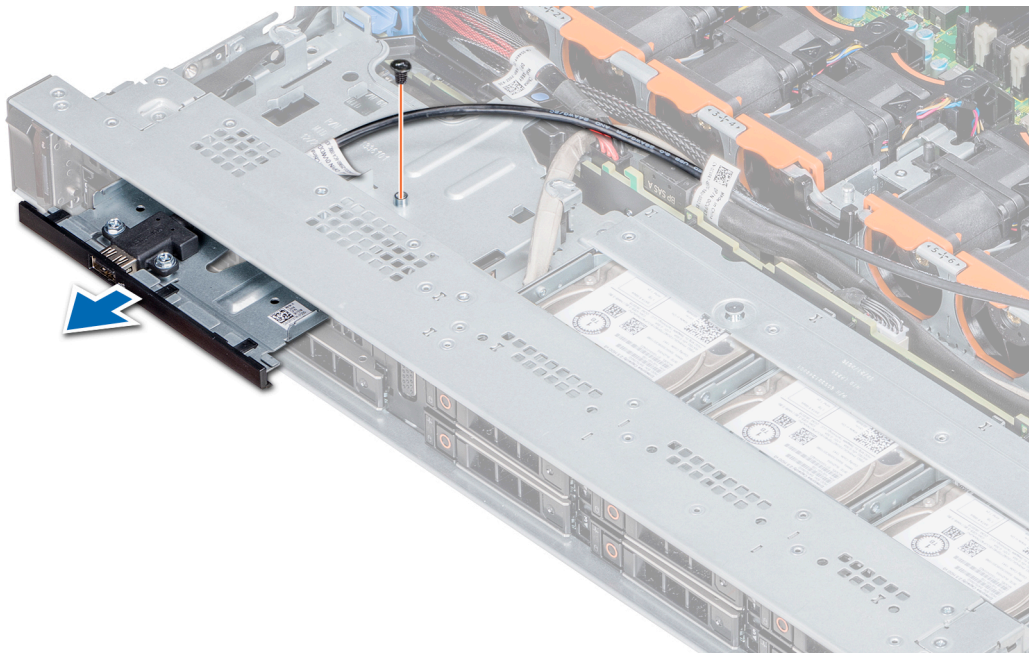

**Figure 106. Removing the USB module**

#### Next steps

[Install the USB module.](#)

# Installing the USB module

## Prerequisites

Follow the safety guidelines listed in [Safety instructions](#) on page 34.

**NOTE:** The procedure to install the USB 3.0 and USB 2.0 modules is similar.

## Steps

1. Route the USB cable on the USB module, through the USB slot on the front panel.
2. Insert the USB module into the slot on the front panel.
3. Align the screw on the module with the screw hole on the system.
4. Using the Phillips #1 screwdriver, replace the screw to secure the module to the system.
5. Route the USB cable and connect it to the USB connector on the system board. For more information, see the System board jumpers and connectors section.

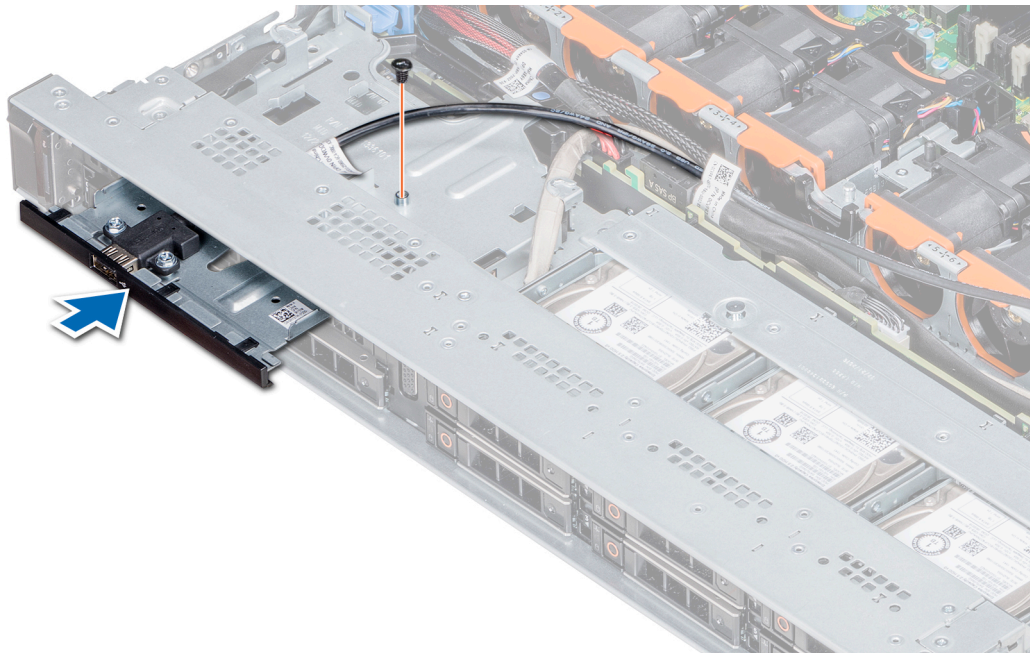

Figure 107. Installing the USB module

## Next steps

1. [Install the air shroud.](#)
2. [Install the backplane cover.](#)
3. Follow the procedure listed in [After working inside your system](#) on page 35.

# VGA module

## Removing the VGA module

### Prerequisites

1. Follow the safety guidelines listed in [Safety instructions](#) on page 34.
2. Follow the procedure listed in [Before working inside your system](#) on page 35.
3. [Remove the front bezel](#)

4. [Remove the backplane cover.](#)
5. [Remove the air shroud.](#)
6. Disconnect the VGA cable from the VGA connector on the system board. For locating the connector, see the [System board jumpers and connectors](#) section.

**i** **NOTE:** Ensure that you note the routing of the cables as you remove them from the system board. Route these cables properly when you replace them to prevent them from being pinched or crimped.

### Steps

1. Using Phillips #1 screwdriver, remove the screw on the VGA module.
2. Slide the module out of the system.

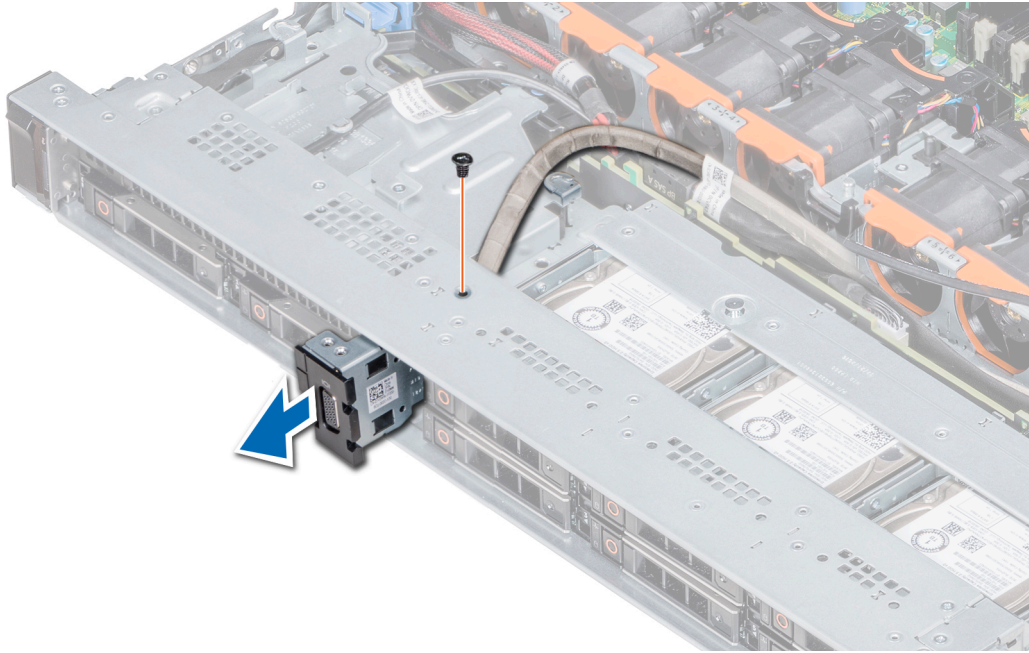

**Figure 108. Removing the VGA module**

### Next steps

1. [Install the VGA module.](#)

## Installing the VGA module

### Prerequisites

1. Follow the safety guidelines listed in [Safety instructions](#) on page 34.
2. Follow the procedure listed in [Before working inside your system](#) on page 35.
3. [Remove the front bezel.](#)
4. [Remove the backplane cover.](#)
5. [Remove the air shroud.](#)

**i** **NOTE:** Ensure that you note the routing of the cables as you remove them from the system board. Route these cables properly when you replace them to prevent them from being pinched or crimped.

### Steps

1. Route the VGA cable through the VGA module slot on the front of the system and slide the VGA module into the slot.
2. Align the hole on the module with the screw hole on the system.
3. Using the Phillips #1 screwdriver, secure the VGA module to the system with the screw.

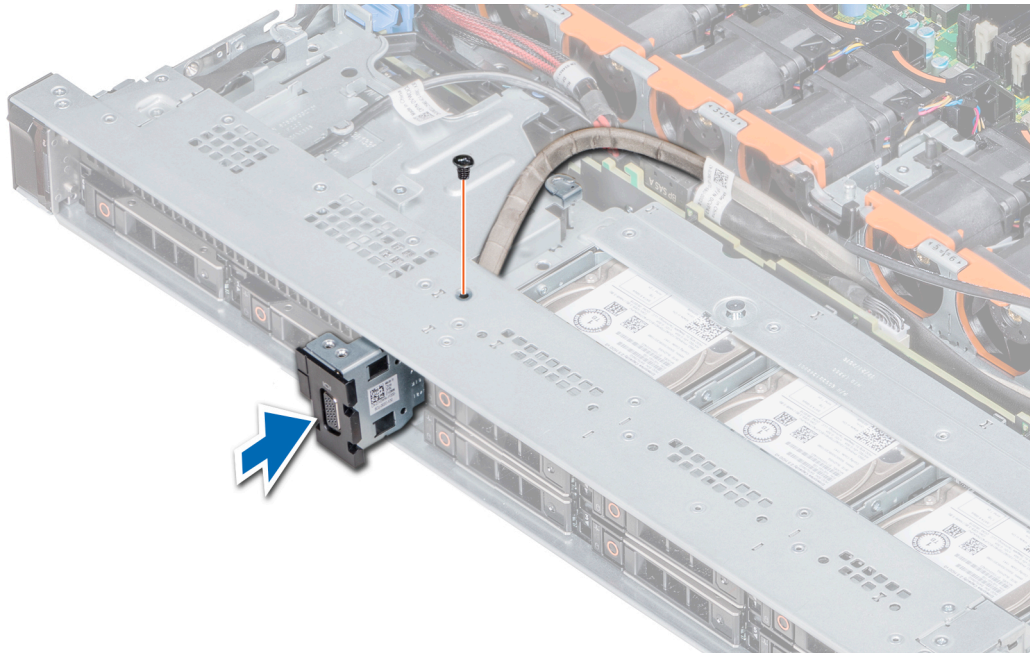

**Figure 109. Installing the VGA module**

#### Next steps

1. Route the VGA cable and connect it to the VGA connector on the system board. For locating the connector, see the [System board jumpers and connectors](#) section.
2. [Install the air shroud.](#)
3. [Install the backplane cover.](#)
4. [Install the front bezel.](#)
5. Follow the procedure listed in [After working inside your system](#) on page 35.

## Optional internal USB memory key

An optional USB memory key can be installed in the internal USB 3.0 port.

**i** **NOTE:** To locate the internal USB port on the system board, see the [System board jumpers and connectors](#) section.

For configurations that support USB 3.0 module, the USB 3.0 module cable connects to the internal USB port on the system board. In this scenario, the default internal USB port is available under the backplane cover. The position of the default internal USB port may vary depending on the configuration of your system.

## Replacing the optional internal USB memory key

#### Prerequisites

**⚠ CAUTION:** To avoid interference with other components in the server, the maximum permissible dimensions of the USB memory key are 15.9 mm wide x 57.15 mm long x 7.9 mm high.

1. Follow the safety guidelines listed in [Safety instructions](#) on page 34.
2. Follow the procedure listed in [Before working inside your system](#) on page 35.

#### Steps

1. Locate the USB port or USB memory key on the system board.  
To locate the USB port, see the [System board jumpers and connectors](#) on page 137.

2. If installed, remove the USB memory key from the USB port.
3. Insert the replacement USB memory key into the USB port.

### Next steps

1. Follow the procedure listed in [After working inside your system](#) on page 35.
2. While booting, press F2 to enter **System Setup** and verify that the system detects the USB memory key.

## Optical drive (optional)

### Removing the optical drive

#### Prerequisites

1. Follow the safety guidelines listed in [Safety instructions](#) on page 34.
2. Follow the procedure listed in [Before working inside your system](#) on page 35.
3. If applicable, [remove the front bezel](#).
4. Disconnect the power and data cables from the connectors on the optical drive.

**NOTE:** Ensure that you note the routing of the power and data cable on the side of the system and drive. Route these cables properly when you replace them to prevent them from being pinched or crimped.

#### Steps

1. Press the release tab to release the optical drive.
2. Slide the optical drive out of the system until it is out of the optical drive slot.
3. If you are not adding a new optical drive, install the optical drive blank. The procedure to install the optical drive blank is the same as the optical drive.

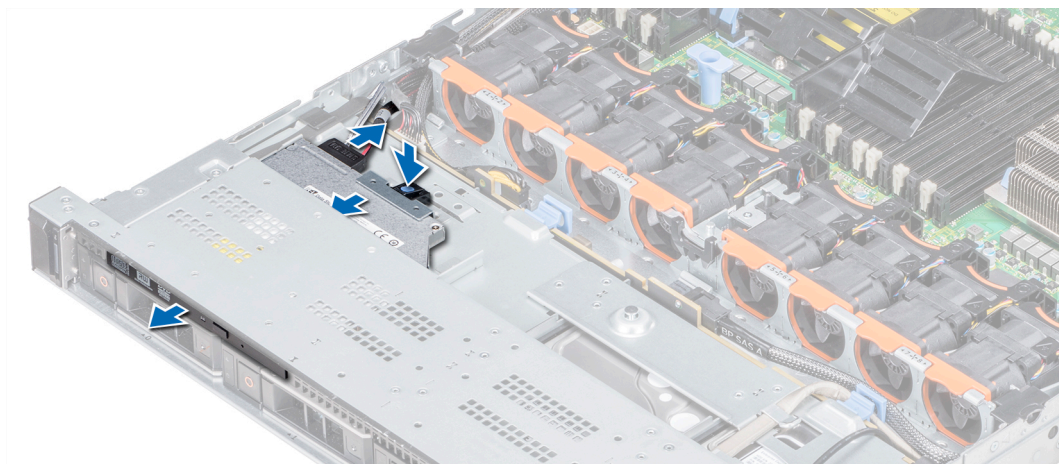

Figure 110. Removing optical drive

#### Next steps

[Install an optical drive.](#)

### Installing the optical drive

#### Prerequisites

Follow the safety guidelines listed in [Safety instructions](#) on page 34.

## Steps

1. Align the optical drive with the optical drive slot on the front of the system.
2. Slide in the optical drive until the release tab snaps into place.

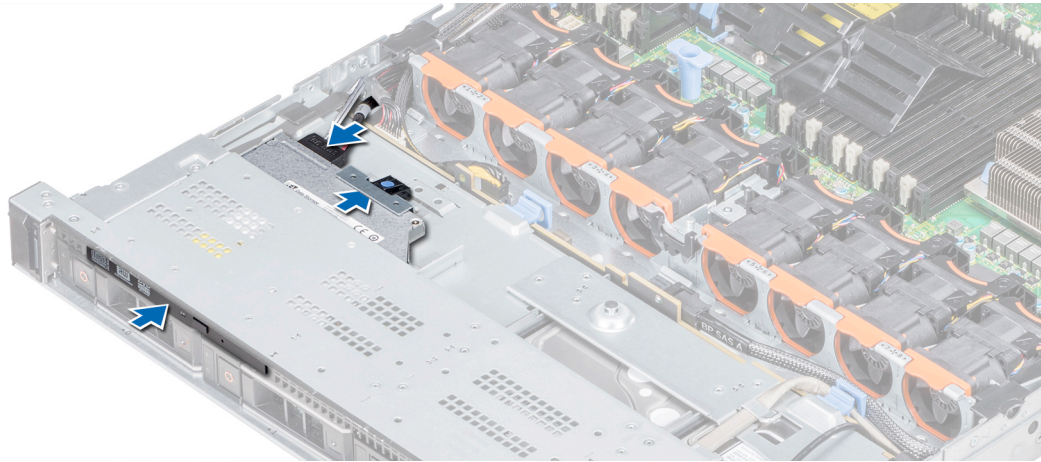

Figure 111. Installing the optical drive

## Next steps

1. Connect the power and data cables to the connector on the optical drive and the connector on the system board.  
**NOTE:** Route the cable properly on the side of the system to prevent it from being pinched or crimped.
2. Follow the procedure listed in [After working inside your system](#) on page 35.

# Power supply units

The power supply unit (PSU) is an internal hardware component which supplies power to the components in the system.

Your system supports one of the following:

- Two 2400 W, 2000 W, 1600 W, 1100 W, 750 W, or 495 W AC PSUs
- Two 1600 W, 1100 W, 750 W, 750 W Mixed Mode, or 495 W AC PSUs
- Two 1100 W DC PSUs
- Two 1100 W or 750 W Mixed Mode HVDC PSUs

**NOTE:** For more information, see the Technical specifications section.

**CAUTION:** If two PSUs are installed, both the PSUs must have the same type of label. For example, Extended Power Performance (EPP) label. Mixing PSUs from previous generations of PowerEdge servers is not supported, even if the PSUs have the same power rating. Mixing PSUs will result in mismatch condition or failure to turn the system on.

**NOTE:** Titanium PSU is nominally rated for 200 V AC to 240 V AC input only.

**NOTE:** When two identical PSUs are installed, power supply redundancy (1+1 – with redundancy or 2+0 – without redundancy) is configured in system BIOS. In redundant mode, power is supplied to the system equally from both PSUs when Hot Spare is disabled. When Hot Spare is enabled, one of the PSUs is put into the sleep mode when system utilization is low in order to maximize efficiency.

**NOTE:** If two PSUs are used, they must be of the same maximum output power.

This section contains information about the hot spare features, wiring instructions for a DC power supply unit, removal and installation of the power supply blank, and AC power supply unit.



## Hot spare feature

Your system supports the hot spare feature that significantly reduces the power overhead associated with power supply unit (PSU) redundancy.

When the hot spare feature is enabled, one of the redundant PSUs is switched to the sleep state. The active PSU supports 100 percent of the system load, thus operating at higher efficiency. The PSU in the sleep state monitors output voltage of the active PSU. If the output voltage of the active PSU drops, the PSU in the sleep state returns to an active output state.

If having both PSUs active is more efficient than having one PSU in the sleep state, the active PSU can also activate the sleeping PSU.

The default PSU settings are as follows:

- If the load on the active PSU is more than 50 percent of PSU rated power wattage, then the redundant PSU is switched to the active state.
- If the load on the active PSU falls below 20 percent of PSU rated power wattage, then the redundant PSU is switched to the sleep state.

You can configure the hot spare feature by using the iDRAC settings. [www.dell.com/poweredgemanuals](http://www.dell.com/poweredgemanuals).

## Removing a power supply unit blank

### Prerequisites

Follow the safety guidelines listed in [Safety instructions](#) on page 34.

### Steps

If you are installing a second power supply unit, remove the power supply unit blank in the bay by pulling the blank outward.

**CAUTION:** To ensure proper system cooling, the power supply unit blank must be installed in the second power supply unit bay in a non-redundant configuration. Remove the power supply unit blank only if you are installing a second power supply unit.

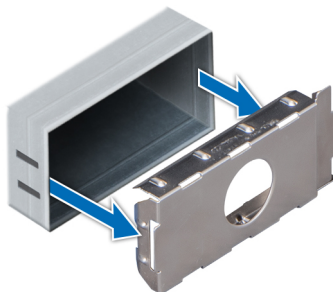

Figure 112. Removing a power supply unit blank

### Next steps

Install the second power supply unit blank.

## Installing a power supply unit blank

### Prerequisites

1. Follow the safety guidelines listed in [Safety instructions](#) on page 34.

**NOTE:** Install the power supply unit (PSU) blank only in the second PSU bay.

### Steps

Align the PSU blank with the PSU slot and push it into the PSU slot until it clicks into place.

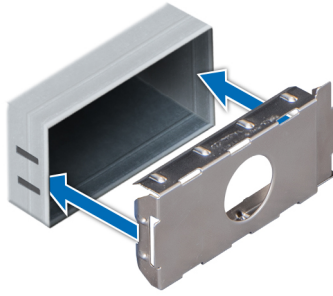

Figure 113. Installing a power supply unit blank

### Next steps

Follow the procedure listed in [After working inside your system](#) on page 35.

## Removing a power supply unit

The procedure for removing AC and DC PSUs is identical.

### Prerequisites

**CAUTION:** The system needs one power supply unit (PSU) for normal operation. On power-redundant systems, remove and replace only one PSU at a time in a system that is powered on.

1. Follow the safety guidelines listed in [Safety instructions](#) on page 34.
2. Disconnect the power cable from the power source and from the PSU you intend to remove, and then remove the cable from the strap on the PSU handle.
3. Unlatch and lift the optional cable management arm if it interferes with the PSU removal.

For information about the cable management arm, see the system's rack documentation at <https://www.dell.com/poweredgemanuals>.

### Steps

Press the orange release latch and slide the PSU out of the system by using the PSU handle.

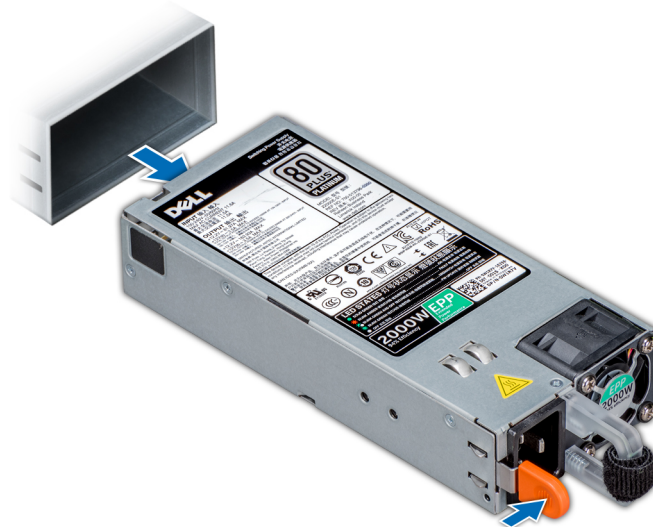

Figure 114. Removing a power supply unit

## Next steps

Install the PSU or the PSU blank.

# Installing a power supply unit

The procedure for installing AC and DC PSUs is identical.

## Prerequisites

1. Follow the safety guidelines listed in [Safety instructions](#) on page 34.
2. For systems that support redundant PSU, ensure that both the PSUs are of the same type and have the same maximum output power.

**i** **NOTE:** The maximum output power (shown in watts) is listed on the PSU label.

## Steps

Slide the PSU into the system until the PSU is fully seated and the release latch snaps into place.

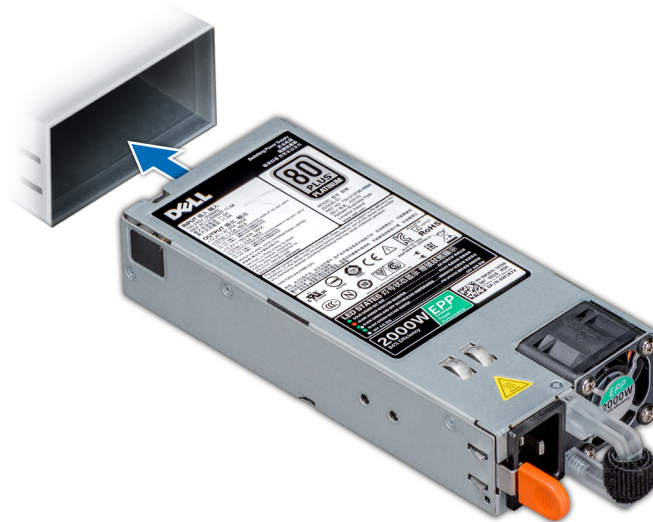

**Figure 115. Installing a power supply unit**

## Next steps

1. If you have unlatched the cable management arm, relatch it. For information about the cable management arm, see the system's rack documentation at <https://www.dell.com/poweredgemanuals>.
2. Connect the power cable to the PSU, and plug the cable into a power outlet.

**⚠ CAUTION:** When connecting the power cable to the PSU, secure the cable to the PSU with the strap.

**i** **NOTE:** When installing, hot swapping, or hot adding a new PSU, wait for 15 seconds for the system to recognize the PSU and determine its status. The PSU redundancy may not occur until discovery is complete. Wait until the new PSU is discovered and enabled before you remove the other PSU. The PSU status indicator turns green to signify that the PSU is functioning properly.

# Removing a DC power supply unit

## Prerequisites

**i** **NOTE:** For equipment using  $-$ (48–60) V DC power supply units (PSUs), a qualified electrician must perform all connections to DC power and to safety grounds. Do not attempt connecting to DC power or installing grounds yourself. All electrical

wiring must comply with applicable local or national codes and practices. Damage due to servicing that is not authorized by Dell is not covered by your warranty. Read and follow all safety instructions that came with the product.

**CAUTION:** The system needs one PSU for normal operation. On power-redundant systems, remove and replace only one PSU at a time in a system that is powered on.

1. Follow the safety guidelines listed in [Safety instructions](#) on page 34.
2. Disconnect the power wires from the power source and the connector from the PSU you intend to remove.
3. Disconnect the safety ground wire.
4. Unlatch and lift the optional cable management arm if it interferes with PSU removal. For information about the cable management arm, see the system's rack documentation at <https://www.dell.com/poweredgemanuals>.

### Steps

Press the release latch and slide the PSU out of the system by using the PSU handle.

### Next steps

[Install the DC PSU.](#)

## Installing DC power supply unit

### Prerequisites

**NOTE:** For equipment using  $-(48-60)$  V DC power supply units (PSUs), a qualified electrician must perform all connections to DC power and to safety grounds. Do not attempt connecting to DC power or installing grounds yourself. All electrical wiring must comply with applicable local or national codes and practices. Damage due to servicing that is not authorized by Dell is not covered by your warranty. Read and follow all safety instructions that came with the product.

1. Follow the safety guidelines listed in [Safety instructions](#) on page 34.
2. For systems that support redundant power supply units (PSUs), ensure that both the PSUs are of the same type and have the same maximum output power.

**NOTE:** The maximum output power (shown in watts) is listed on the PSU label.

### Steps

Slide the PSU into the system until the PSU is fully seated and the release latch snaps into place.

### Next steps

1. If you have unlatched the cable management arm, relatch it. For information about the cable management arm, see the system's rack documentation at <https://www.dell.com/poweredgemanuals>.
2. Connect the safety ground wire.
3. Install the DC power connector in the PSU.

**CAUTION:** When connecting the power wires, ensure that you secure the wires with the strap to the PSU handle.

4. Connect the wires to a DC power source.

**NOTE:** When installing, hot-swapping, or hot-adding a new PSU, wait for 15 seconds for the system to recognize the PSU and determine its status. The PSU status indicator turns green to signify that the PSU is functioning properly.

## Wiring instructions for a DC power supply unit

Your system supports up to two  $-(48-60)$  V DC power supply units (PSUs).

**NOTE:** For equipment using  $-(48-60)$  V DC power supply units (PSUs), a qualified electrician must perform all connections to DC power and to safety grounds. Do not attempt connecting to DC power or installing grounds yourself. All electrical wiring must comply with applicable local or national codes and practices. Damage due to servicing that is not authorized by Dell is not covered by your warranty. Read and follow all safety instructions that came with the product.

**CAUTION:** Wire the unit with copper only, unless otherwise specified, use only 10 American Wire Gauge (AWG) wire rated minimum 90°C for source and return. Protect the -(48-60) V DC (1 wire) with a branch circuit over-current protection rated 50 A for DC with a high interrupt current rating.

**CAUTION:** Connect the equipment to a -(48-60) V DC supply source that is electrically isolated from the AC source (reliably grounded -(48-60) V DC SELV source). Ensure that the -(48-60) V DC source is efficiently secured to earth (ground).

**NOTE:** A readily accessible disconnect device that is suitably approved and rated shall be incorporated in the field wiring.

## Input requirements

- Supply voltage: -(48-60) V DC
- Current consumption: 32 A (maximum)

## Kit contents

- Dell part number 6RYJ9 terminal block or equivalent (1)
- #6-32 nut equipped with lock washer (1)

## Required tools

Wire-stripper pliers capable of removing insulation from size 10 AWG solid or stranded, insulated copper wire.

**NOTE:** Use alpha wire part number 3080 or equivalent (65/30 stranding).

## Required wires

- One UL 10 AWG, 2 m maximum (stranded) black wire [-(48-60) V DC].
- One UL 10 AWG, 2 m maximum (stranded) red wire (V DC return).
- One UL 10 AWG, 2 m maximum, green with a yellow stripe, stranded wire (safety ground).

# System board

## Removing the system board

### Prerequisites

**CAUTION:** If you are using the Trusted Platform Module (TPM) with an encryption key, you may be prompted to create a recovery key during program or System Setup. Be sure to create and safely store this recovery key. If you replace this system board, you must supply the recovery key when you restart your system or program before you can access the encrypted data on your drives.

**CAUTION:** Do not attempt to remove the TPM plug-in module from the system board. Once the TPM plug-in module is installed, it is cryptographically bound to that specific system board. Any attempt to remove an installed TPM plug-in module breaks the cryptographic binding, and it cannot be re-installed or installed on another system board.

1. Follow the safety guidelines listed in [Safety instructions](#) on page 34.
2. Follow the procedure listed in [Before working inside your system](#) on page 35.
3. Remove the following:

**CAUTION:** Do not lift the system board by holding a memory module, processor, or other components.

- a. [Air shroud](#)

- b. All expansion cards and risers
- c. Integrated storage controller card
- d. Internal USB key (if applicable)
- e. USB 3.0 module (if applicable))
- f. Processors and heat sink modules
- g. Processors blanks (if installed)

**CAUTION:** To prevent damage to the processor socket when replacing a faulty system board, ensure that you cover the processor socket with the processor dust cover.

- h. Memory modules and memory module blanks
- i. Network daughter card

### Steps

1. Disconnect all cables from the system board.

**CAUTION:** Take care not to damage the system identification button while removing the system board from the chassis.

2. Holding the post, lift the blue release pin, and slide the system board toward the front of the system to disengage the connectors from the slots on the chassis.
3. Incline the system board at an angle, and lift the system board out of the chassis.

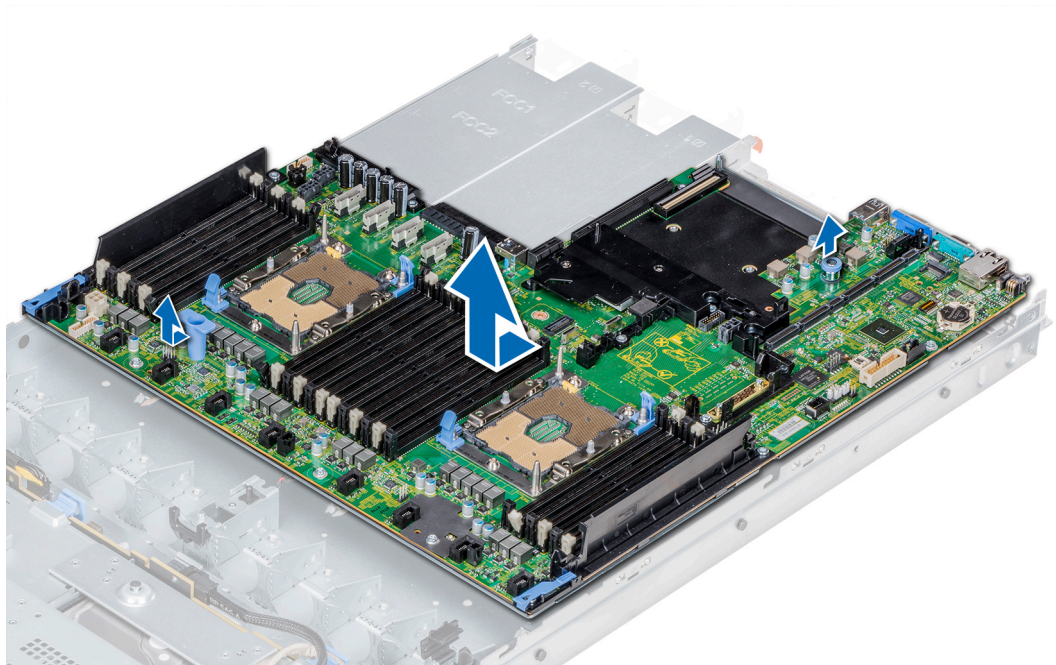

Figure 116. Removing the system board

### Next steps

Install the system board.

## Installing the system board

### Prerequisites

Follow the safety guidelines listed in [Safety instructions](#) on page 34.

### Steps

1. Unpack the new system board assembly.

**CAUTION:** Do not lift the system board by holding a memory module, processor, or other components.

**CAUTION:** Take care not to damage the system identification button while placing the system board into the chassis.

2. Holding the post and release pin, incline the system board, and lower the system board into the chassis.
3. Slide the system board toward the back of the system until the release pin clicks into place.

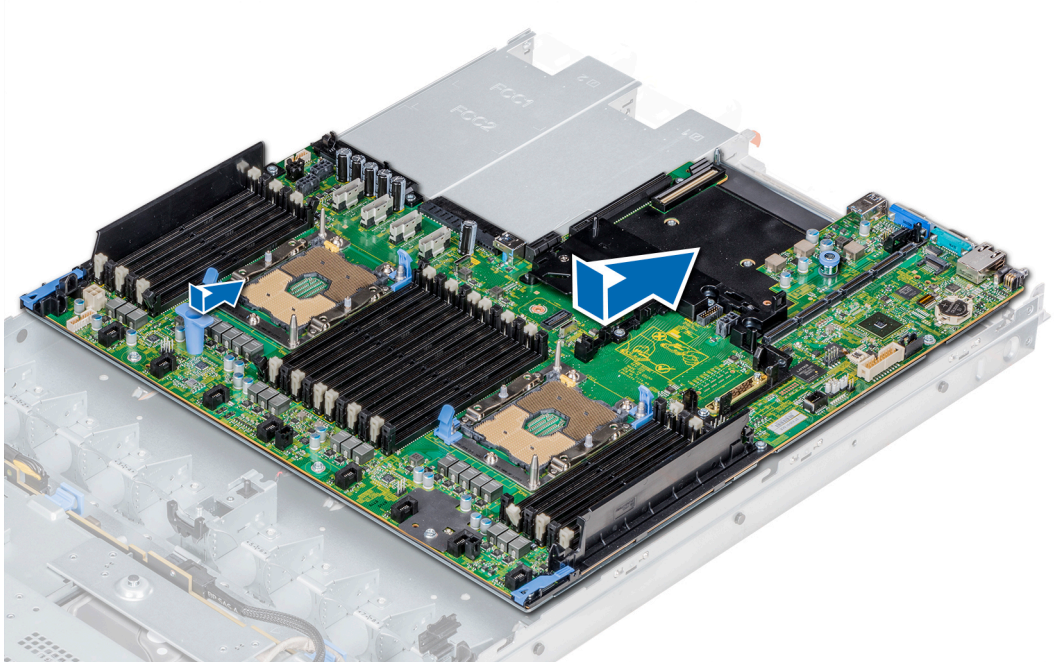

**Figure 117. Installing the system board**

### Next steps

1. Replace the following:
  - a. Trusted Platform Module (TPM)
  - b. Integrated storage controller card
  - c. Internal USB key (if applicable)
  - d. USB 3.0 module (if applicable)
  - e. All expansion cards and risers
  - f. Processors and heat sink modules
  - g. Processors blanks (if applicable)
  - h. Memory modules and memory module blanks
  - i. Network daughter card
  - j. Air shroud
2. Reconnect all cables to the system board.

**NOTE:** Ensure that the cables inside the system are routed along the chassis wall and secured using the cable securing bracket.
3. Follow the procedure listed in [After working inside your system](#) on page 35.
4. Ensure that you:
  - a. Use the Easy Restore feature to restore the Service Tag. For more information, see the [Restoring the Service Tag by using the Easy Restore](#) feature section.
  - b. If the Service Tag is not backed up in the backup flash device, [enter the Service Tag](#) manually.
  - c. Update the BIOS and iDRAC versions.
  - d. Re-enable the Trusted Platform Module (TPM). For more information, see the [Upgrading the Trusted Platform Module](#) section.
5. Import your new or existing iDRAC Enterprise license.

For more information, see *Integrated Dell Remote Access Controller User's Guide*, at [www.dell.com/poweredge manuals](http://www.dell.com/poweredge manuals).

## Restoring the system using Easy Restore

The easy restore feature enables you to restore your service tag, license, UEFI configuration, and the system configuration data after replacing the system board. All data is backed up in a backup flash device automatically. If BIOS detects a new system board, and the service tag in the backup flash device, BIOS prompts the user to restore the backup information.

### About this task

Below is a list of options available:

- Restore the service tag, license, and diagnostics information, press **Y**
- Navigate to the Lifecycle Controller based restore options, press **N**.
- Restore data from a previously created **Hardware Server Profile**, press **F10**  
**i** **NOTE:** When the restore process is complete, BIOS prompts to restore the system configuration data.
- To restore the system configuration data, press **Y**
- To use the default configuration settings, press **N**  
**i** **NOTE:** After the restore process is complete, system reboots.

## Manually update the Service Tag

After replacing a system board, if Easy Restore fails, follow this process to manually enter the Service Tag, using **System Setup**.

### About this task

If you know the system service tag, use the **System Setup** menu to enter the service tag.

### Steps

1. Power on the system.
2. To enter the **System Setup**, press **F2**.
3. Click **Service Tag Settings**.
4. Enter the service tag.  
**i** **NOTE:** You can enter the service tag only when the **Service Tag** field is empty. Ensure that you enter the correct service tag. Once the service tag is entered, it cannot be updated or changed.
5. Click **OK**.

## Entering the system Service Tag by using System Setup

If Easy Restore fails to restore the Service Tag, use System Setup to enter the Service Tag.

### Steps

1. Turn on the system.
2. Press F2 to enter System Setup.
3. Click **Service Tag Settings**.
4. Enter the Service Tag.  
**i** **NOTE:** You can enter the Service Tag only when the **Service Tag** field is empty. Ensure that you enter the correct Service Tag. After the Service Tag is entered, it cannot be updated or changed.
5. Click **OK**.
6. Import your new or existing iDRAC Enterprise license.

For more information, see the *Integrated Dell Remote Access Controller User's Guide* at [www.dell.com/poweredge manuals](http://www.dell.com/poweredge manuals).



# Trusted Platform Module

## Upgrading the Trusted Platform Module

### Prerequisites

1. Follow the safety guidelines listed in [Safety instructions](#) on page 34.
2. Follow the procedure listed in [Before working inside your system](#) on page 35.

### NOTE:

- Ensure that your operating system supports the version of the TPM module being installed.
- Ensure that you download and install the latest BIOS firmware on your system.
- Ensure that the BIOS is configured to enable UEFI boot mode.

### About this task

 **CAUTION:** If you are using the Trusted Platform Module (TPM) with an encryption key, you may be prompted to create a recovery key during program or System Setup. Work with the customer to create and safely store this recovery key. When replacing this system board, you must supply the recovery key when you restart your system or program before you can access the encrypted data on your hard drives.

 **CAUTION:** Once the TPM plug-in module is installed, it is cryptographically bound to that specific system board. Any attempt to remove an installed TPM plug-in module breaks the cryptographic binding, the removed TPM cannot be reinstalled or installed on another system board.

## Removing the TPM

### Steps

1. Locate the TPM connector on the system board.
2. Press to hold the module down and remove the screw using the security Torx 8-bit shipped with the TPM module.
3. Slide the TPM module out from its connector.
4. Push the plastic rivet away from the TPM connector and rotate it 90° counterclockwise to release it from the system board.
5. Pull the plastic rivet out of its slot on the system board.

## Installing the TPM

### Steps

1. To install the TPM, align the edge connectors on the TPM with the slot on the TPM connector.
2. Insert the TPM into the TPM connector such that the plastic rivet aligns with the slot on the system board.
3. Press the plastic rivet until the rivet snaps into place.

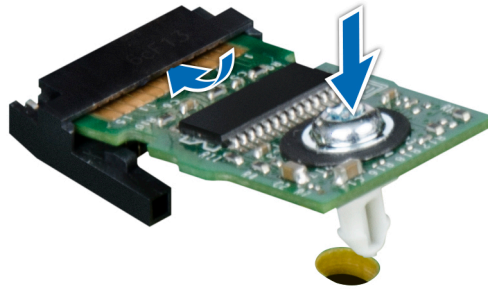

Figure 118. Installing the TPM

### Next steps

1. [Install the system board.](#)
2. Follow the procedure listed in [After working inside your system](#) on page 35.

## Initializing TPM for BitLocker users

### Steps

Initialize the TPM.

For more information, see <http://technet.microsoft.com/en-us/library/cc753140.aspx>

The **TPM Status** changes to **Enabled, Activated**.

## Initializing the TPM 1.2 for TXT users

### Steps

1. While booting your system, press F2 to enter System Setup.
2. On the **System Setup Main Menu** screen, click **System BIOS > System Security Settings**.
3. From the **TPM Security** option, select **On with Pre-boot Measurements**.
4. From the **TPM Command** option, select **Activate**.
5. Save the settings.
6. Restart your system.
7. Enter **System Setup** again.
8. On the **System Setup Main Menu** screen, click **System BIOS > System Security Settings**.
9. From the **Intel TXT** option, select **On**.

## Initializing the TPM 2.0 for TXT users

### Steps

1. While booting your system, press F2 to enter System Setup.
2. On the **System Setup Main Menu** screen, click **System BIOS > System Security Settings**.
3. From the **TPM Security** option, select **On**.
4. Save the settings.
5. Restart your system.
6. Enter **System Setup** again.
7. On the **System Setup Main Menu** screen, click **System BIOS > System Security Settings**.

8. Select the **TPM Advanced Settings** option.
9. From the **TPM2 Algorithm Selection** option, select **SHA256**, then go back to **System Security Settings** screen.
10. On the **System Security Settings** screen, from the **Intel TXT** option, select **On**.
11. Save the settings.
12. Restart your system.

## Control panel

### Removing the left control panel

#### Prerequisites

1. Follow the safety guidelines listed in [Safety instructions](#) on page 34.
2. Follow the procedure listed in [Before working inside your system](#) on page 35.
3. [Remove the air shroud](#).
4. For ease of removal of the left control panel, [remove the cooling fan #1](#) to access the cable latch.

#### Steps

1. Pull the cable latch and disconnect the control panel cable from the system board connector.
2. Pull the cable latch and disconnect the control panel cable from the system board connector.
3. Using a Phillips #1 screwdriver, remove the screws that secure the cable cover.

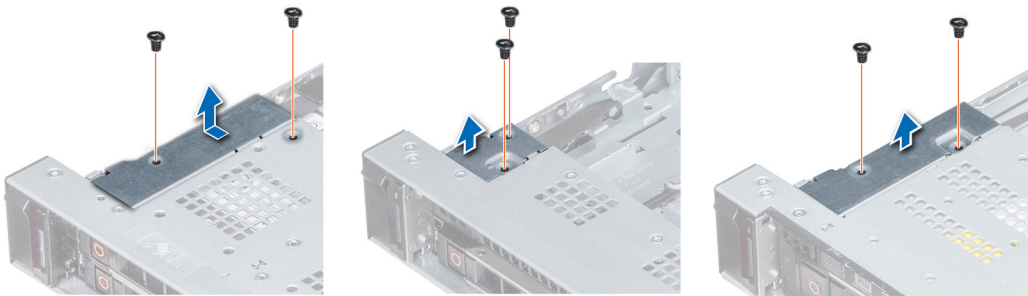

Figure 119. Removing the cable cover

4. Using a Phillips #1 screwdriver, remove the screws that connect the control panel to the system.

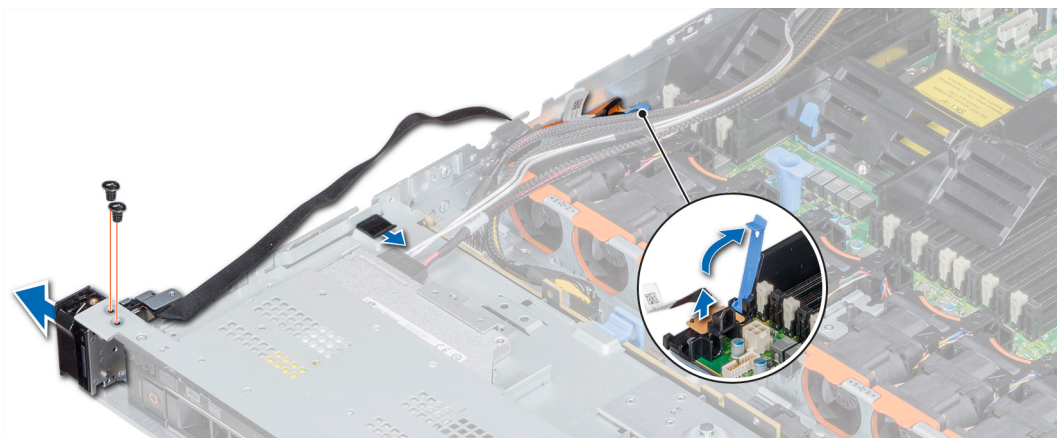

Figure 120. Removing left control panel

5. Holding the control panel by its sides, remove the control panel away from the system.

### Next steps

Install the left control panel.

## Installing the left control panel

### Prerequisites

Follow the safety guidelines listed in [Safety instructions](#) on page 34.

### Steps

1. Route the control panel cable through the side wall of the system.
2. Align the left control panel assembly with the control panel slot on the system and place the assembly in the slot on the system.
3. Connect the control panel cable to the system board connector and secure it using cable latch.
4. Using a Phillips #1 screwdriver, install the screws that secure the control panel to the system.

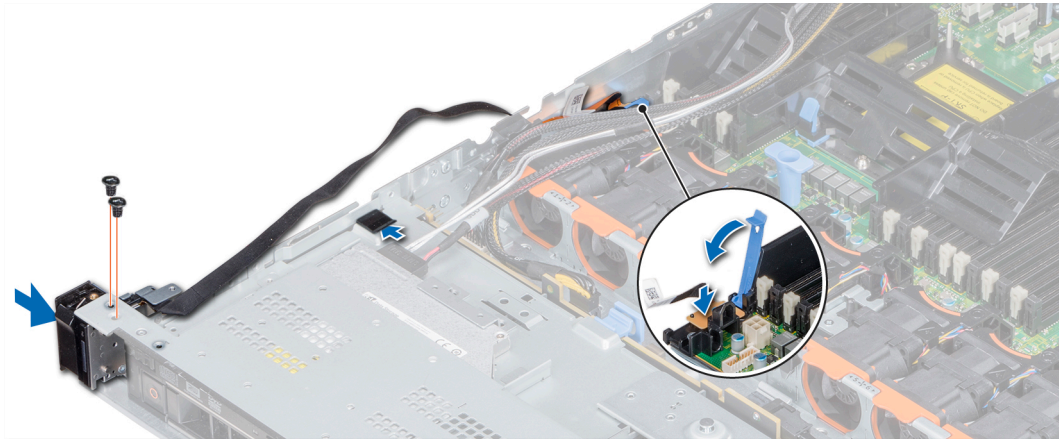

Figure 121. Installing the left control panel

5. Using Phillips #1 screwdriver, install the screws that secure the cable cover to the system.

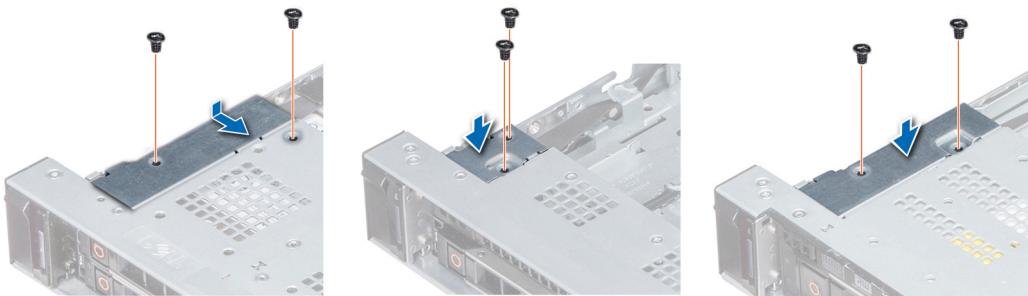

Figure 122. Installing the cable cover

### Next steps

1. Install the air shroud.
2. If applicable, install the cooling fan #1.
3. Follow the procedure listed in [After working inside your system](#) on page 35.

# Removing the right control panel

## Prerequisites

1. Follow the safety guidelines listed in [Safety instructions](#) on page 34.
2. Follow the procedure listed in [Before working inside your system](#) on page 35.
3. For ease of removal of the right control panel, [remove the cooling fan #8](#) to access the cable latch.

## Steps

1. Lift the cable latch and disconnect the control panel cable from the connector on the system board.

**NOTE:** Ensure that you note the routing of the cables as you remove them from the system board. You must route the cables properly when you replace them to prevent the cables from being pinched or crimped.

2. Using a Phillips #1 screwdriver, remove the screws that secure the cable cover to the system.



Figure 123. Removing the cable cover

3. Using a Phillips #1 screwdriver, remove the screw that secures the control panel to the system.

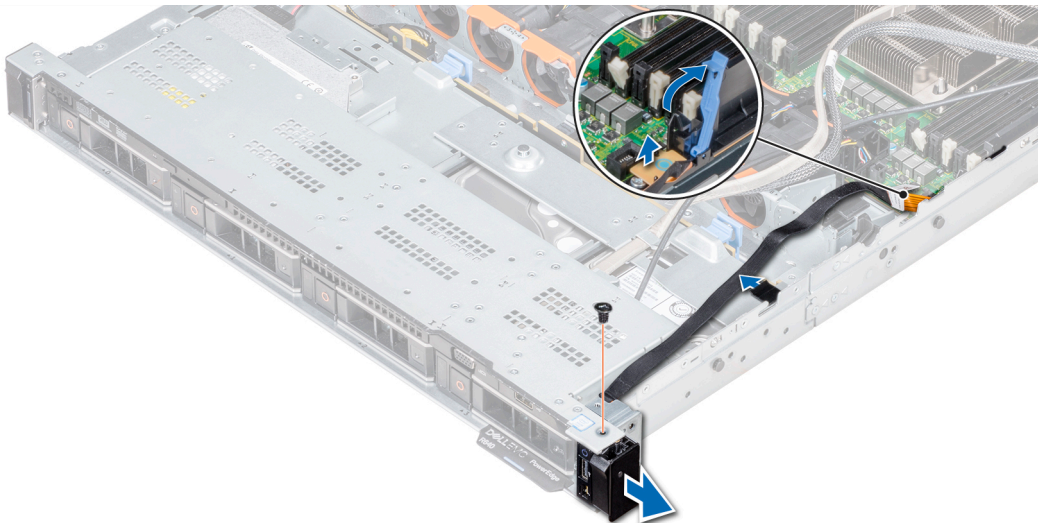

Figure 124. Removing right control panel

4. Holding by the sides, remove the right control panel away from the system.
5. Holding the control panel by its sides, remove the control panel away from the system.

## Next steps

[Install the right control panel.](#)

# Installing the right control panel

## Prerequisites

Follow the safety guidelines listed in [Safety instructions](#) on page 34.

## Steps

1. Route the control panel cable through the side wall of the system.
2. Align the right control panel assembly with the control panel slot on the system.
3. Connect the control panel cable to the connector on the system board and lower the cable latch to secure the cable in place.
4. Using a Phillips #1 screwdriver, install the screw that secures the control panel to the system.

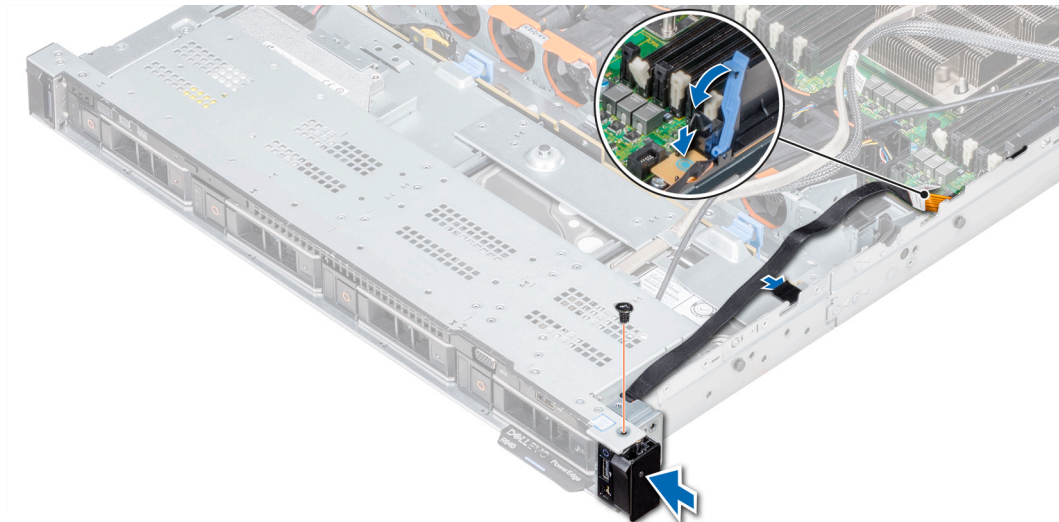

Figure 125. Installing the right control panel

5. Using a Phillips #1 screwdriver, install the screws that secure the cable cover to the system.



Figure 126. Installing the cable cover

## Next steps

1. If applicable, [install the cooling fan #8](#).
2. Follow the procedure listed in [After working inside your system](#) on page 35.

# System diagnostics

If you experience a problem with your system, run the system diagnostics before contacting Dell for technical assistance. The purpose of running system diagnostics is to test your system hardware without using additional equipment or risking data loss. If you are unable to fix the problem yourself, service and support personnel can use the diagnostics results to help you solve the problem.

## Topics:

- [Dell Embedded System Diagnostics](#)

## Dell Embedded System Diagnostics

**NOTE:** The Dell Embedded System Diagnostics is also known as Enhanced Pre-boot System Assessment (ePSA) diagnostics.

The Embedded System Diagnostics provides a set of options for particular device groups or devices allowing you to:

- Run tests automatically or in an interactive mode
- Repeat tests
- Display or save test results
- Run thorough tests to introduce additional test options to provide extra information about the failed device(s)
- View status messages that inform you if tests are completed successfully
- View error messages that inform you of problems encountered during testing

## Running the Embedded System Diagnostics from Boot Manager

Run the Embedded System Diagnostics (ePSA) if your system does not boot.

### Steps

1. When the system is booting, press F11.
2. Use the up arrow and down arrow keys to select **System Utilities > Launch Diagnostics**.
3. Alternatively, when the system is booting, press F10, select **Hardware Diagnostics > Run Hardware Diagnostics**. The **ePSA Pre-boot System Assessment** window is displayed, listing all devices detected in the system. The diagnostics starts executing the tests on all the detected devices.

## Running the Embedded System Diagnostics from the Dell Lifecycle Controller

### Steps

1. As the system boots, press F10.
2. Select **Hardware Diagnostics → Run Hardware Diagnostics**. The **ePSA Pre-boot System Assessment** window is displayed, listing all devices detected in the system. The diagnostics starts executing the tests on all the detected devices.

## System diagnostic controls

Menu	Description
<b>Configuration</b>	Displays the configuration and status information of all detected devices.

<b>Menu</b>	<b>Description</b>
<b>Results</b>	Displays the results of all tests that are run.
<b>System health</b>	Provides the current overview of the system performance.
<b>Event log</b>	Displays a time-stamped log of the results of all tests run on the system. This is displayed if at least one event description is recorded.



## Jumpers and connectors

This topic provides specific information about the jumpers. It also provides some basic information about jumpers and switches and describes the connectors on the various boards in the system. Jumpers on the system board help to disable the system and setup passwords. You must know the connectors on the system board to install components and cables correctly.

### Topics:

- [System board jumpers and connectors](#)
- [System board jumper settings](#)
- [Disabling forgotten password](#)

### System board jumpers and connectors

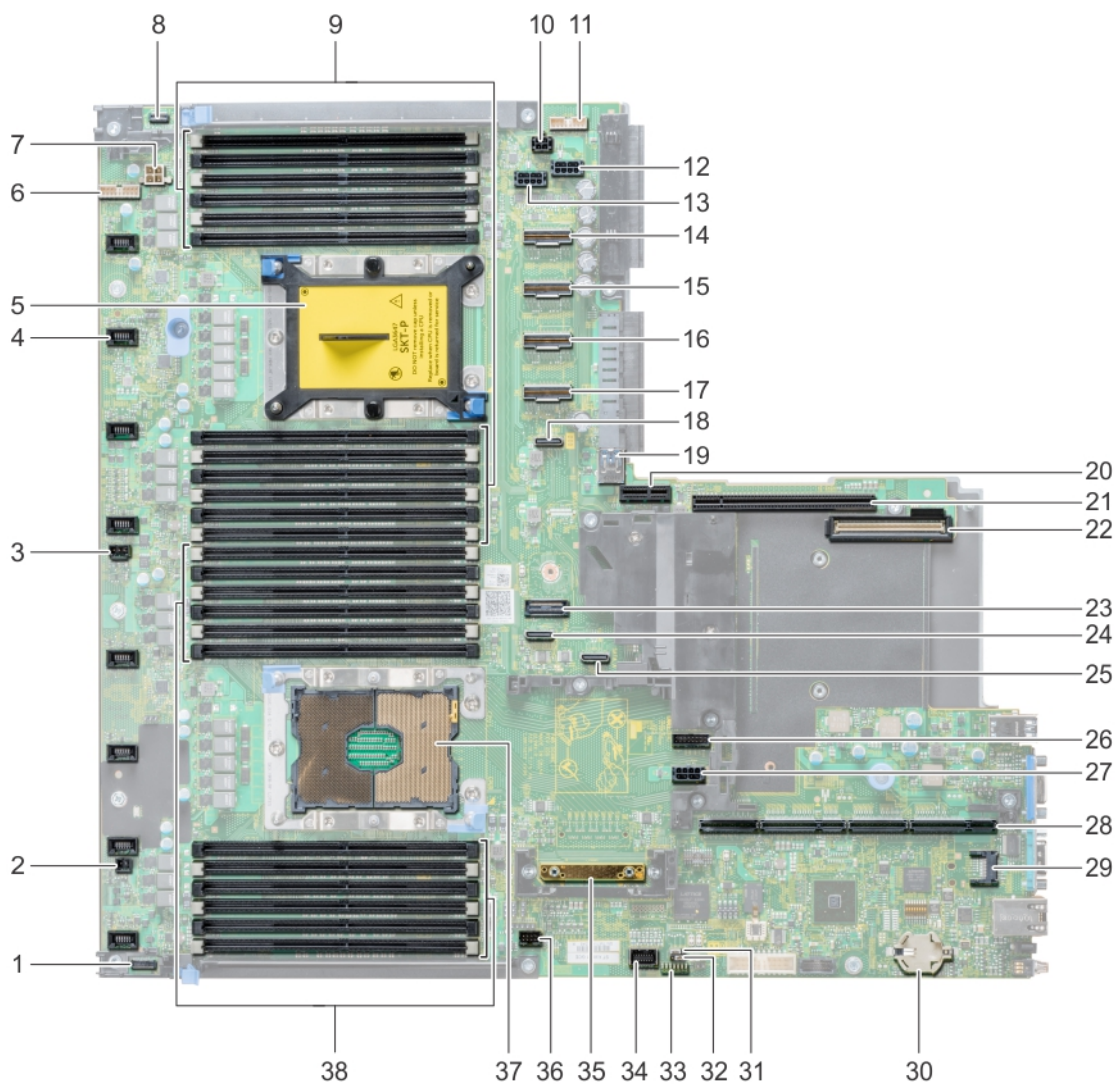

Figure 127. System board jumpers and connectors

**Table 33. System board jumpers and connectors**

<b>Item</b>	<b>Connector</b>	<b>Description</b>
1.	P_RG1_CP	Right panel connector
2.	J_WS_PWRBTN	Power button connector
3.	J_INTRUSION_DET1	Intrusion switch connector
4.	J_FAN1U_2	Cooling fan connector
5.	Processor 2	Processor socket 2
6.	J_BATT_SIG	Battery signal connector
7.	J_BATT_PWR	Battery power connector
8.	CP	Left control panel connector
9.	B6, B12, B5, B11, B4, B10, B7, B1, B8, B2, B9, B3	Memory module sockets
10.	J_ODD	Optical drive connector
11.	J_BP_SIG1	Backplane signal connector 1
12.	J_BP1	Backplane connector 1
13.	J_BP2	Backplane connector 2
14.	J_STORAGE_M4	SAS connector 4
15.	J_STORAGE_M3	SAS connector 3
16.	J_STORAGE_M2	SAS connector 2
17.	J_STORAGE_M1	SAS connector 1
18.	J_SATA_C	SATA connector
19.	J_USB_INT	Internal USB port
20.	J_IDSDM_vFLASH	IDS DM/vFlash module connector
21.	J_RISER2	Riser 2 connector
22.	J_NDC	Network Daughter Card connector
23.	J1	SATA connector
24.	J_SATA_B	SATA connector
25.	J_SATA_A	SATA connector
26.	J_BP_SIG0	Backplane signal connector 0
27.	J_BPO	Backplane power connector
28.	J_R1_SS82_2	Riser 1 connector
29.	J_TPM_MODULE1	TPM module connector
30.	BATTERY	Battery connector
31.	NVRAM_CLR	Clear NVRAM
32.	PWRD_EN	Reset BIOS password
33.	LED's	System board diagnostic LED indicators
34.	J_VGA	VGA connector
35.	J_STORAGE1	Mini PERC controller connector
36.	J_USB_INT1	USB connector
37.	Processor 1	Processor socket 1

**Table 33. System board jumpers and connectors (continued)**

Item	Connector	Description
38	A6, A12, A5, A11, A4, A10, A7, A1, A8, A2, A9, A3	Memory module sockets

## System board jumper settings

For information on resetting the password jumper to disable a password, see the [Disabling a forgotten password](#) section.

## Disabling forgotten password

The software security features of the system include a system password and a setup password. The password jumper enables or disables password features and clears any password(s) currently in use.

### Prerequisites

**CAUTION:** Many repairs may only be done by a certified service technician. You should only perform troubleshooting and simple repairs as authorized in your product documentation, or as directed by the online or telephone service and support team. Damage due to servicing that is not authorized by Dell is not covered by your warranty. Read and follow the safety instructions that are shipped with your product.

### Steps

1. Power off the system, including any attached peripherals, and disconnect the system from the electrical outlet.
2. Remove the system cover.
3. Move the jumper on the system board jumper from pins 2 and 4 to pins 4 and 6.
4. Install the system cover.

The existing passwords are not disabled (erased) until the system boots with the jumper on pins 4 and 6. However, before you assign a new system and/or setup password, you must move the jumper back to pins 2 and 4.

**NOTE:** If you assign a new system and/or setup password with the jumper on pins 4 and 6, the system disables the new password(s) the next time it boots.

5. Reconnect the system to its electrical outlet and power on the system, including any attached peripherals.
6. Power off the system, including any attached peripherals, and disconnect the system from the electrical outlet.
7. Remove the system cover.
8. Move the jumper on the system board jumper from pins 4 and 6 to pins 2 and 4.
9. Install the system cover.
10. Reconnect the system to its electrical outlet and power on the system, including any attached peripherals.
11. Assign a new system and/or setup password.

# Getting help

## Topics:

- [Contacting Dell EMC](#)
- [Documentation feedback](#)
- [Accessing system information by using QRL](#)
- [Receiving automated support with SupportAssist](#)
- [Recycling or End-of-Life service information](#)

## Contacting Dell EMC

Dell EMC provides several online and telephone based support and service options. If you do not have an active internet connection, you can find contact information about your purchase invoice, packing slip, bill, or Dell EMC product catalog. Availability varies by country and product, and some services may not be available in your area. To contact Dell EMC for sales, technical assistance, or customer service issues:

### Steps

1. Go to [www.dell.com/support/home](http://www.dell.com/support/home).
2. Select your country from the drop-down menu on the lower right corner of the page.
3. For customized support:
  - a. Enter your system Service Tag in the **Enter your Service Tag** field.
  - b. Click **Submit**.  
The support page that lists the various support categories is displayed.
4. For general support:
  - a. Select your product category.
  - b. Select your product segment.
  - c. Select your product.  
The support page that lists the various support categories is displayed.
5. For contact details of Dell EMC Global Technical Support:
  - a. Click [Contact Technical Support](#).
  - b. Enter your system Service Tag in the **Enter your Service Tag** field on the Contact Us webpage.

## Documentation feedback

You can rate the documentation or write your feedback on any of our Dell EMC documentation pages and click **Send Feedback** to send your feedback.

## Accessing system information by using QRL

You can use the Quick Resource Locator (QRL) located on the information tag in the front of the system, to access the information about the PowerEdge system.

### Prerequisites

Ensure that your smartphone or tablet has the QR code scanner installed.

The QRL includes the following information about your system:

- How-to videos

- Reference materials, including the Installation and Service Manual, LCD diagnostics, and mechanical overview
- Your system service tag to quickly access your specific hardware configuration and warranty information
- A direct link to Dell to contact technical assistance and sales teams

### Steps

1. Go to [www.dell.com/qrl](http://www.dell.com/qrl) and navigate to your specific product or
2. Use your smartphone or tablet to scan the model-specific Quick Resource (QR) code on your system or in the Quick Resource Locator section.

## Quick Resource Locator for R640



Figure 128. Quick Resource Locator for PowerEdge R640

## Receiving automated support with SupportAssist

Dell EMC SupportAssist is an optional Dell EMC Services offering that automates technical support for your Dell EMC server, storage, and networking devices. By installing and setting up a SupportAssist application in your IT environment, you can receive the following benefits:

- **Automated issue detection** — SupportAssist monitors your Dell EMC devices and automatically detects hardware issues, both proactively and predictively.
- **Automated case creation** — When an issue is detected, SupportAssist automatically opens a support case with Dell EMC Technical Support.
- **Automated diagnostic collection** — SupportAssist automatically collects system state information from your devices and uploads it securely to Dell EMC. This information is used by Dell EMC Technical Support to troubleshoot the issue.
- **Proactive contact** — A Dell EMC Technical Support agent contacts you about the support case and helps you resolve the issue.

The available benefits vary depending on the Dell EMC Service entitlement purchased for your device. For more information about SupportAssist, go to [www.dell.com/supportassist](http://www.dell.com/supportassist).

## Recycling or End-of-Life service information

Take back and recycling services are offered for this product in certain countries. If you want to dispose of system components, visit [www.dell.com/recyclingworldwide](http://www.dell.com/recyclingworldwide) and select the relevant country.