

# dji MIC MINI 2

## User Manual

v1.0 2026.04





This document is copyrighted by DJI with all rights reserved. Unless otherwise authorized by DJI, you are not eligible to use or allow others to use the document or any part of the document by reproducing, transferring or selling the document. Only refer to this document and the content thereof as instructions to operate DJI products. The document should not be used for other purposes.

In the event of divergence among different versions, the English version shall prevail.

### **Searching for Keywords**

Search for keywords such as “battery” and “install” to find a topic. If you are using Adobe Acrobat Reader to read this document, press Ctrl+F on Windows or Command+F on Mac to begin a search.

### **Navigating to a Topic**

View a complete list of topics in the table of contents. Click on a topic to navigate to that section.

### **Printing this Document**

This document supports high resolution printing.

# Using this Manual

## Legend

 Important

 Hints and Tips

 Reference

## Read Before Use

DJI™ provides you with tutorial videos and the following documents:

1. *Safety Guidelines*
2. *Quick Start Guide*
3. *User Manual*

It is recommended to watch all the tutorial videos and read the *Safety Guidelines* before using for the first time. Make sure to review the *Quick Start Guide* before using for the first time and refer to this *User Manual* for more information.

# Contents

<b>Using this Manual</b>	<b>3</b>
Legend	3
Read Before Use	3
<b>1 Product Profile</b>	<b>5</b>
1.1 Transmitter	5
1.2 Receiver	6
1.3 Charging Case	8
<b>2 Use</b>	<b>10</b>
2.1 Installing the Windscreen	10
2.2 Magnetic Front Cover	10
2.3 Wearing the Transmitter	11
2.4 Linking the Transmitter and Receiver	11
Linking via the Charging Case	11
Linking Manually	12
2.5 Using with a Phone	13
2.6 Using with a Camera	14
2.7 Using with a Computer	15
2.8 Transmitter Directly Connected to OsmoAudio Filming Devices	15
2.9 Storage	16
2.10 Charging	16
<b>3 Firmware Upgrade and Parameter Adjustment</b>	<b>18</b>
3.1 Connecting to the DJI Mimo App	18
Connecting via the Adapter	18
Connecting via Bluetooth	18
3.2 Adjusting Parameters	19
3.3 Firmware Update	19
<b>4 Appendix</b>	<b>20</b>
4.1 Specifications	20
4.2 Aftersales Information	20

# 1 Product Profile

 For instructions on using the mobile receiver, refer to DJI Mic Series Mobile Receiver User Manual at <https://www.dji.com/downloads/products/mic-mini-2#doc>.

## 1.1 Transmitter

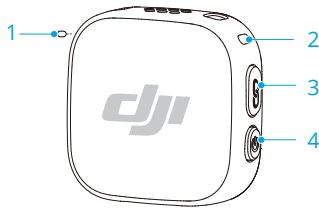













### 1. Noise Cancellation LED

Solid yellow: Noise cancelling enabled

LED off: Noise cancelling disabled

### 2. System Status LED

Battery Level		
 —	Solid red	≤10%
 —	Solid green/blue <sup>[1]</sup>	>10%
Linking/Connection Status		
 —	Solid green	Linked with the receiver
 ·····	Blinks green slowly	No receiver linked
 —	Solid blue	Connected to a Bluetooth device/mobile receiver
 ·····	Blinks blue slowly	No Bluetooth device connected
 ·····	Blinks blue and green alternately	Linking/Connecting
Battery Level During Charging <sup>[1]</sup>		
 ·····	Blinks green/blue slowly	0-25%

 × 2 .....	Blinks green/blue twice	26-50%
 × 3 .....	Blinks green/blue three times	51-75%
 × 4 .....	Blinks green/blue four times	76-100%
	Off	Charging complete <sup>[2]</sup>
<b>Other Status</b>		
 —	Solid yellow	Firmware updating

[1] The color of the light depends on the wireless working mode. Take the green light as an example.

[2] When charging is complete, the LED stays on for one minute and then goes off.

### 3. Linking Button

Press and hold for two seconds to start linking.

After connecting the microphone to the DJI filming equipment, press to start or stop recording videos.

### 4. Power Button

Press and hold for two seconds to power on or off.

Press twice to enable or disable Noise Cancelling.

## 1.2 Receiver

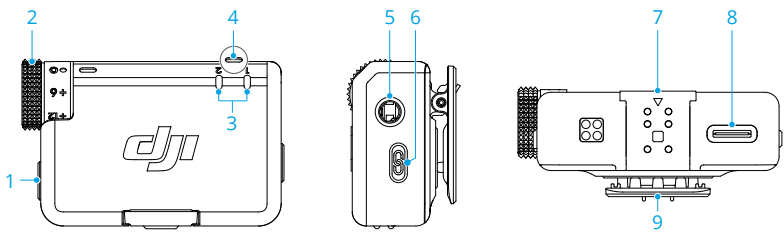





### 1. Power Button

Press and hold for two seconds to power on or off.













### 2. Dial

Rotate to adjust the volume of the receiver.

### 3. Transmitter Status LED

Battery Level		
 —	Solid red	0-10%
 —	Solid green	>10%
Status		
	Off	No receiver linked
	Blinks green quickly	Linking/Connecting
 —	Solid yellow	Noise cancelling enabled

### 4. Receiver Status LED

Battery Level		
 —	Solid red	0-10%
Channel		
 —	Solid green	Mono/Safety Track
 —	Solid cyan	Stereo
	Blinks green/cyan slowly <sup>[1]</sup>	No audio recording device linked
Bluetooth Connection		
 —	Solid blue	Connected to a Bluetooth device
	Blinks blue slowly	No Bluetooth device connected
Battery Level During Charging		
	Blinks green slowly	0-25%
 × 2	Blinks green twice	26-50%
 × 3	Blinks green three times	51-75%
 × 4	Blinks green four times	76-100%
	Off	Fully charged
Firmware Update		
 —	Solid yellow	Firmware updating

[1] The color of the light depends on the wireless working mode. Take the green light as an example.

5. 3.5mm Audio Output Jack

For audio output to a camera.

6. Linking Button

Press and hold for two seconds to start linking. Double-press to switch between Mono and Stereo.

7. Expansion Port

Used for connecting to the phone adapter.

8. Data Port (USB-C)

9. Clip

## 1.3 Charging Case

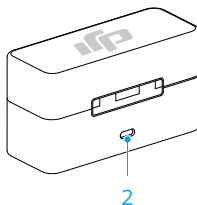
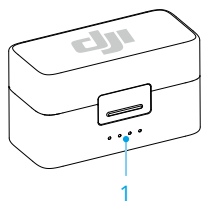

1. Battery Level LEDs

- LED is on
- LED is blinking
- LED is off

Battery Level During Charging (LEDs blink in sequence)



76-99%



51-75%



26-50%



≤ 25%



Fully charged

Battery Level



76-100%



51-75%



26-50%



10-25%



&lt;10%

---

## 2. Charging Port (USB-C)

---



- Fully charge the battery at least once every three months to maintain battery health. If the battery is not used for an extended period, battery performance may be affected or may even cause permanent battery damage.
-

## 2 Use

### 2.1 Installing the Windscreen

In outdoor or windy environments, use the windscreens to reduce wind noise and improve audio quality.

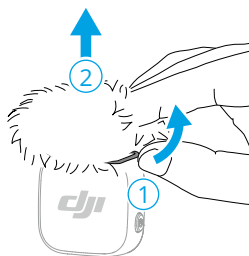
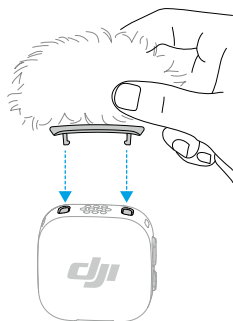

### 2.2 Magnetic Front Cover

The front cover attaches magnetically and can be replaced for styling changes.

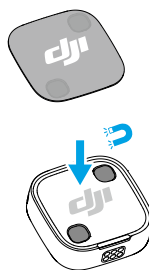
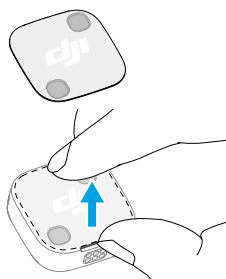

## 2.3 Wearing the Transmitter

The transmitter can be attached to clothing using the clip and magnet.

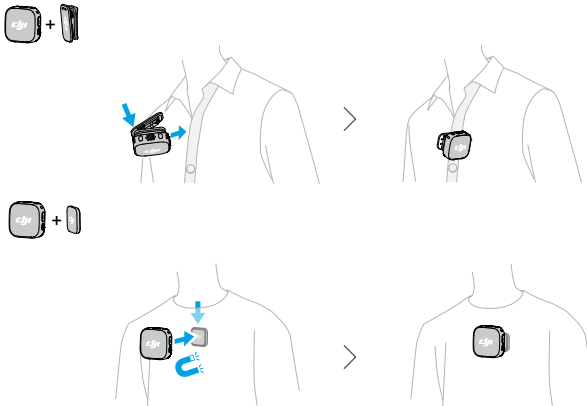

- 💡 The magnetic clip features a detachable, rotating design, allowing the transmitter to face the sound source directly when clipped on the side or inverted, resulting in improved audio quality.

## 2.4 Linking the Transmitter and Receiver

The transmitter and receiver in the combos are linked by default. Follow the steps below to link the transmitter and receiver if they become unlinked.

### Linking via the Charging Case

Place the transmitters and the receiver in the charging case to link them automatically.

- 💡 If the system status LED of the transmitter shows blue, press the linking button twice to change it to green before placing the transmitter in the charging case.

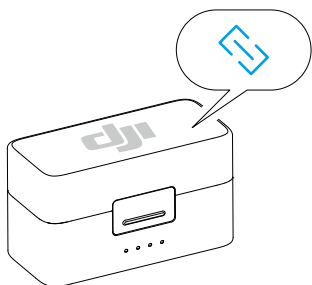

## Linking Manually

1. Press and hold the linking button on the transmitter for two seconds until the system status LED blinks blue and green alternately.
2. Press and hold the linking button on the receiver for two seconds until the transmitter status LED on the front of the receiver blinks green rapidly, indicating that the device is in linking status. The status LEDs will turn solid green after successful linking.

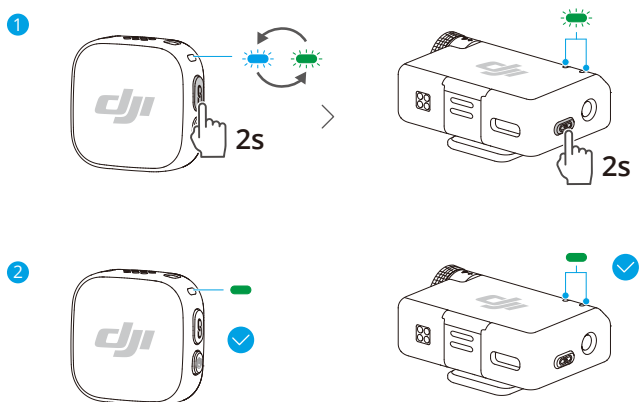

---

 The receiver can link with up to two DJI Mic Mini or DJI Mic Mini 2 transmitters in any combination.

---

## 2.5 Using with a Phone

### Mounting the Receiver to Your Phone via Adapter

Install the receiver to the smartphone using the adapter, then clip or magnetically attach the transmitter to the collar. The phone can now capture audio through the transmitter.

- 💡 • Press the linking button on the transmitter to start and stop recording. (For apps that use volume buttons as shutter controls only)
- For extended filming or live streaming, it is recommended to use the adapter to attach the receiver to the phone. After installation, when using the charging cable to charge the receiver, the phone can be charged simultaneously.
- The Lightning adapter is sold separately.

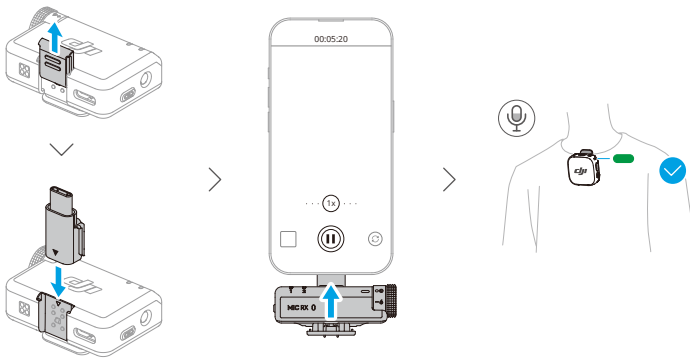

### Connecting the Transmitter to Your Phone via Bluetooth

1. When the transmitter is powered on, press and hold the linking button on the transmitter for two seconds until the system status LED blinks blue and green alternately.
2. Enable Bluetooth on the phone and select the name of your microphone among the searched Bluetooth devices to connect. Connection is successful when the status LED on the transmitter is in solid blue.

The transmitter will then function as an audio input device and can be used with third-party recording or live streaming applications.



## 2.6 Using with a Camera

Mount the receiver to the camera using the clip and connect the audio cable. The transmitter will then capture audio for the camera.

- After installation and connection, refer to Instructions on Recommended Gain for Camera Setup at <https://www.dji.com/downloads/products/mic-mini-2#doc> for more information.
- After adjusting the camera gain, it is recommended to increase the gain of the receiver for better audio quality.

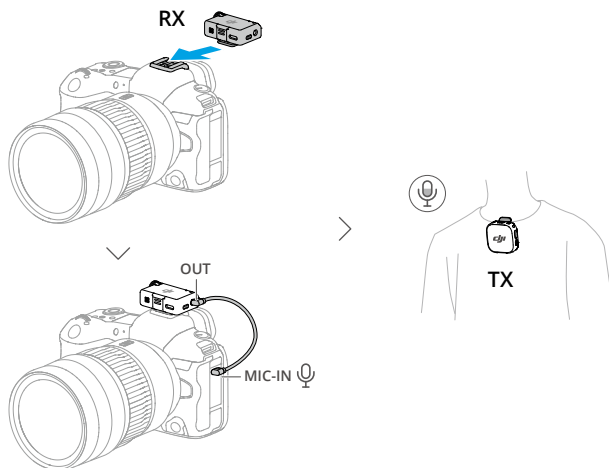

## 2.7 Using with a Computer

Connect the receiver to the computer using the provided charging cable or adapter and set the audio input options on the computer. The transmitter can then be used as an external microphone.

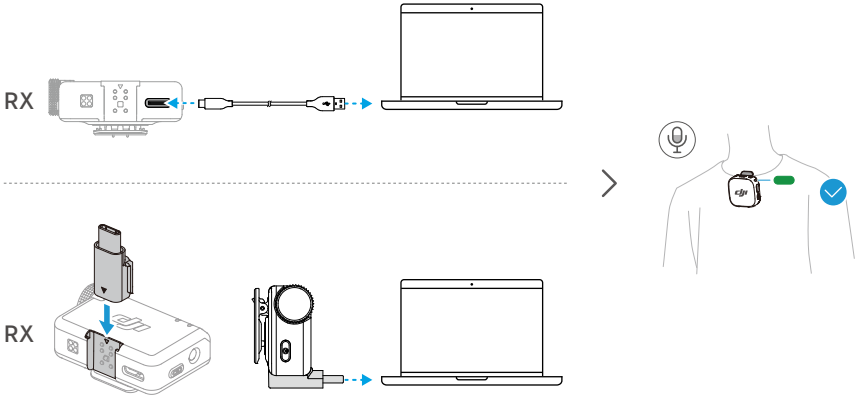

## 2.8 Transmitter Directly Connected to OsmoAudio Filming Devices

The transmitter can connect to phones or OsmoAudio filming devices via Bluetooth.

Operation on Osmo Pocket 3 is demonstrated as an example. The interface may vary depending on the device used.

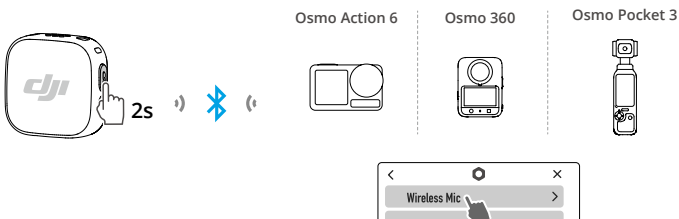

1. Enter the system settings interface of DJI filming devices. Tap **Wireless Microphone** and add the transmitter. Connection is successful when the status LED on the transmitter is in solid blue.

2. Press the linking button on the transmitter to start or stop recording.
3. Swipe down on the Wireless Microphone interface to configure audio-related parameters for the transmitter. Swipe left on the camera interface to set microphone gain and noise cancellation.

---

💡 Visit <https://www.dji.com/downloads/products/mic-mini-2#doc> and check OsmoAudio Compatibility List for supported devices and features.

---

## 2.9 Storage

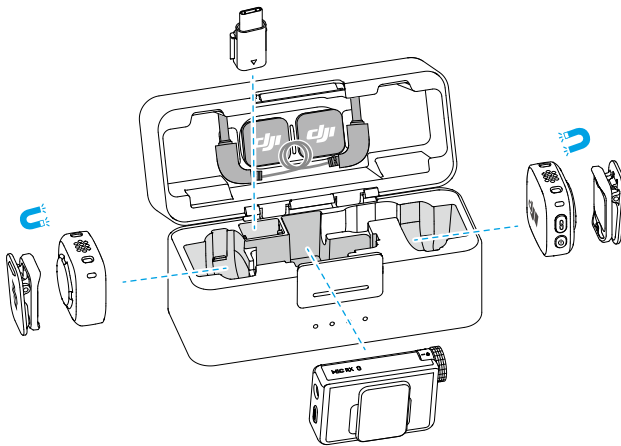

- 
- 💡
- The storage slots with magnets also hold clips.
  - Avoid stacking accessories in the charging case to prevent pressure on the receiver screen.
- 

## 2.10 Charging

### Charging with the Charging Case

Place the transmitters and the receiver in the charging case to start charging simultaneously. If the charging case runs out of power, use the provided USB-C cable to recharge. The transmitter and receiver will automatically power on once removed from the charging case.

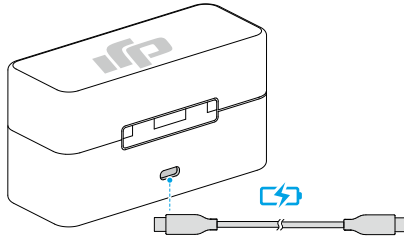

### Charging without the Charging Case

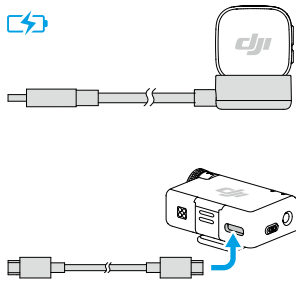

## 3 Firmware Upgrade and Parameter Adjustment

After connecting the microphone to the DJI Mimo app, you can update the firmware or adjust parameter settings using your phone.

### 3.1 Connecting to the DJI Mimo App

#### Connecting via the Adapter

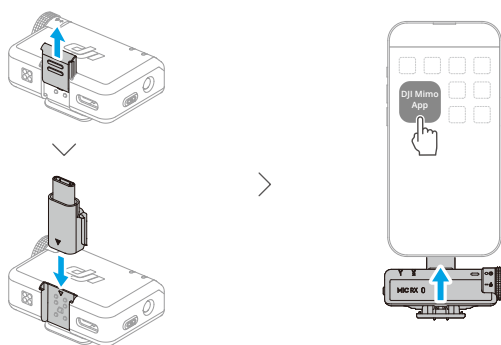

💡 Make sure that the transmitter and receiver are linked.

#### Connecting via Bluetooth

##### Connecting the Transmitter

1. Connect the transmitter to your phone via Bluetooth. Refer to [Using with a Phone](#) for connection instructions.
2. Open the DJI Mimo app to automatically search for nearby available devices. Tap to connect once the transmitter is discovered. After successful connection, the app will automatically enter the device settings interface.

##### Connecting the Receiver (iOS only)

1. When the receiver is powered off, press and hold the power button for six seconds. The system status LED on the receiver will blink green and then blink blue, indicating that the receiver is ready to be connected.

2. Open the DJI Mimo app to automatically search for nearby available devices. Tap to connect once the receiver is discovered. After successful connection, the app will automatically enter the device settings interface.

## 3.2 Adjusting Parameters

In the device settings interface of the DJI Mimo app, you can view connected devices and their battery status or adjust parameters.

## 3.3 Firmware Update

When new firmware is available, a notification will appear at the top of the Home page in the app. Tap to update the firmware.

Tap **About Devices** on the device setting interface of the DJI Mimo app to view the device name, SN code, and firmware version.

---

 When updating the firmware on an iOS device, disconnect the adapter and then connect the transmitter and receiver to the DJI Mimo app via Bluetooth separately.

---

## 4 Appendix

### 4.1 Specifications

Visit the following website for specifications.

<https://www.dji.com/mic-mini-2/specs>

### 4.2 Aftersales Information

Visit <https://www.dji.com/support> to learn more about aftersales service policies, repair services, and support.

WE ARE HERE FOR YOU



WeChat

Contact **DJI Support**

This content is subject to change without prior notice.

Download the latest version from



<https://www.dji.com/downloads/products/mic-mini-2#doc>

If you have any questions about this document, contact DJI by sending a message to [DocSupport@dji.com](mailto:DocSupport@dji.com)

DJI is a trademark of DJI.

Copyright © 2026 DJI All Rights Reserved.