

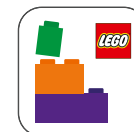

10359



Booklet available in English
Heft in deutscher Sprache erhältlich
Livret disponible en français
Libretto disponibile in italiano
Folleto disponible en español
如需中文版手册



LEGO® Builder





LEGO.com/sustainable-packaging



FR
DONNEZ
OU
RECYCLEZ



ASSOCIATION

OU



MAGASIN

OU



DÉCHÈTERIE

Adresses sur quefairedemesdechets.fr



BUILDER



Apple and the Apple logo are trademarks of Apple Inc., registered in the U.S. and other countries and regions. App Store is a service mark of Apple Inc. Google Play and the Google Play logo are trademarks of Google LLC. Tencent and the Tencent logo are trademarks of Tencent Inc.

LEGO.com/devicecheck



LEGO® Builder

Building serenity

Allow yourself to be whisked away to a serene, tranquil garden and, please, stay as long as you like. Maybe you feel inspired to nurture your creative roots or cultivate your own little corner of mindful activity and reflection. This is your space. We hope you will feel right at home among the thriving flora and wildlife by the fountain. You might recognise some of them from your own garden or a familiar place you have visited on a treasured trip to your dream destination.

Every element is as authentic to the area, culture and architecture as possible. The gorgeous decorative tiles are inspired by *zellij* tiles, which influenced building traditions in North Africa and Southern Europe throughout history and add a gorgeously vivid atmosphere to buildings, interior decorations and gardens. We also decided to introduce a new addition to the LEGO® moths and butterflies collection with the mesmerisingly green Spanish moon moth. You can breathe new life into your garden as you move plants to different locations to suit your mood or let them take turns soaking up the sun or cooling down in the shade. You can even move around larger parts of the model to create different shapes and expressions.



“Bring this idyllic Fountain Garden to life
– and a tiny bit of summer atmosphere into
your home, all year round.”

– The LEGO® Design Team

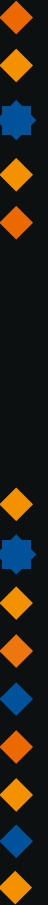





The life in
your garden





1

Pelophylax perezi

Iberian waterfrog



2

Emberiza citrinella

Yellowhammer



3

Graellsia isabellae

Spanish moon moth



4

Pelargonium x hortorum

Red garden geranium



5

Bougainvillea

Pink bougainvillea flower

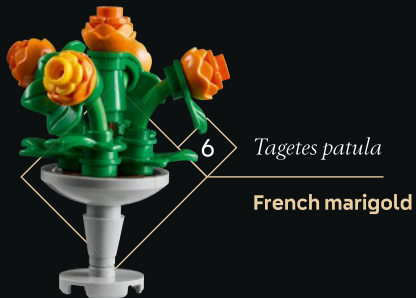

6

Tagetes patula

French marigold

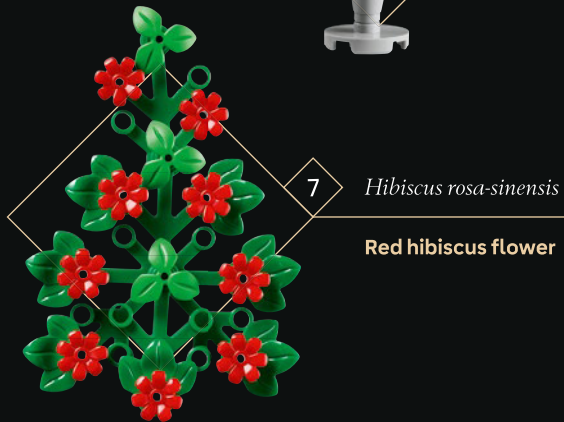

7

Hibiscus rosa-sinensis

Red hibiscus flower

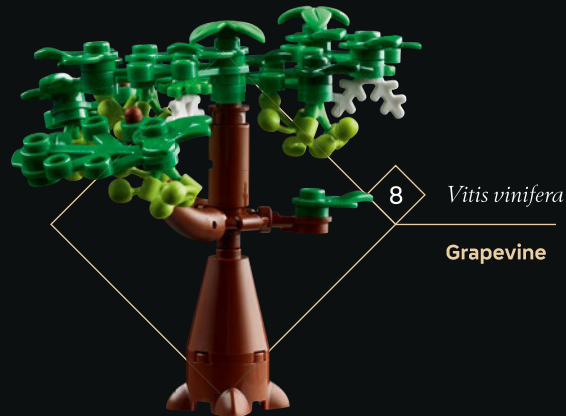

8

Vitis vinifera

Grapevine



9

Petunia axillaris

White petunia

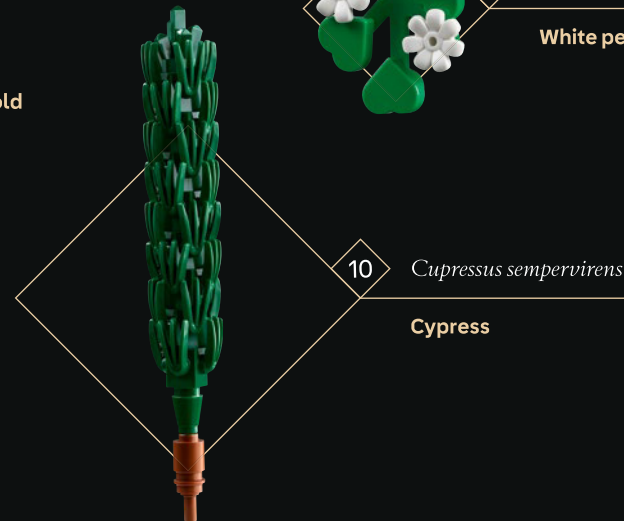

10

Cupressus sempervirens

Cypress



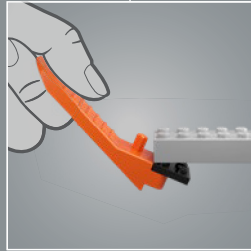
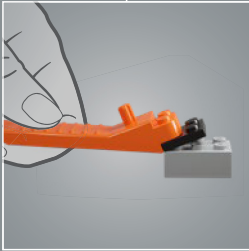
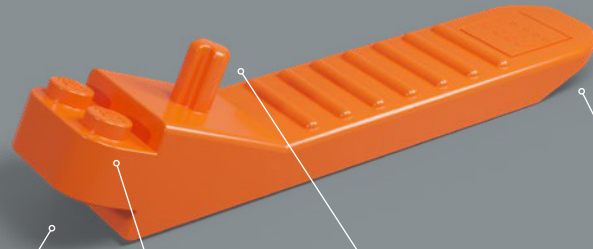

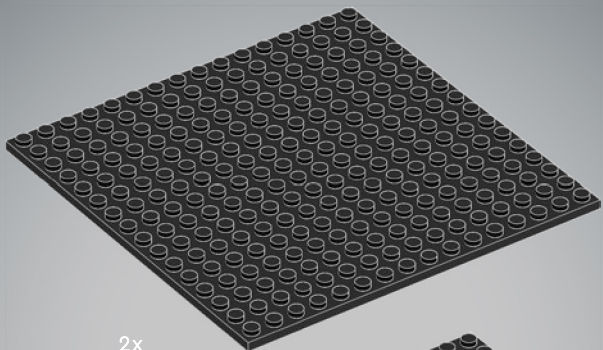

2x

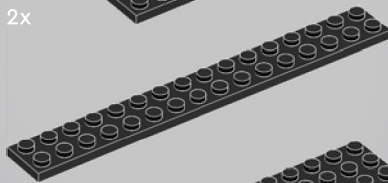

1x

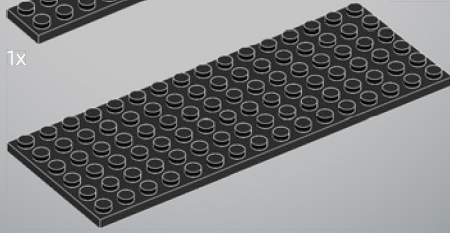

2x

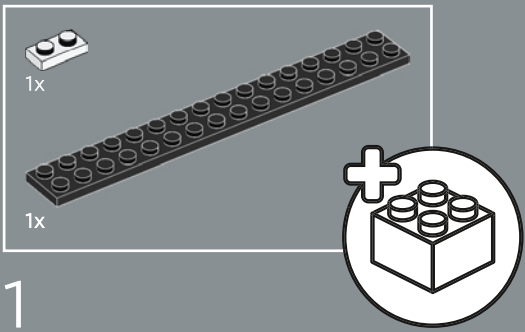

1

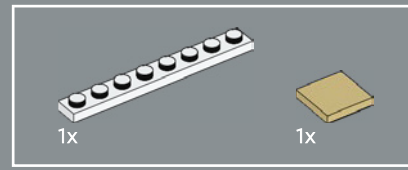
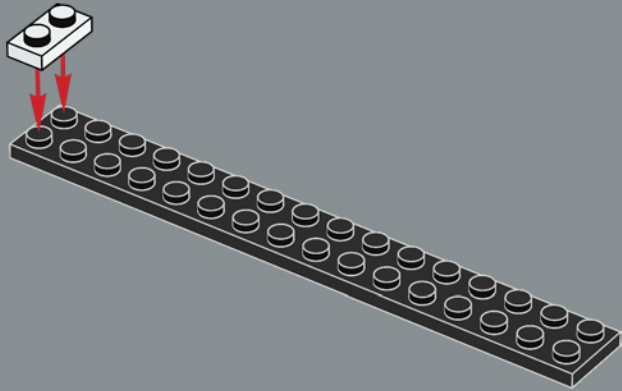

2

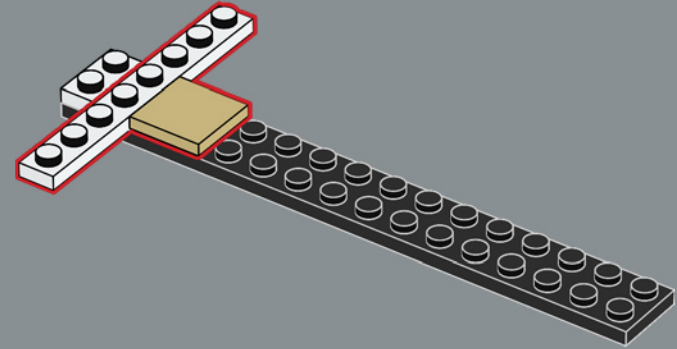

3

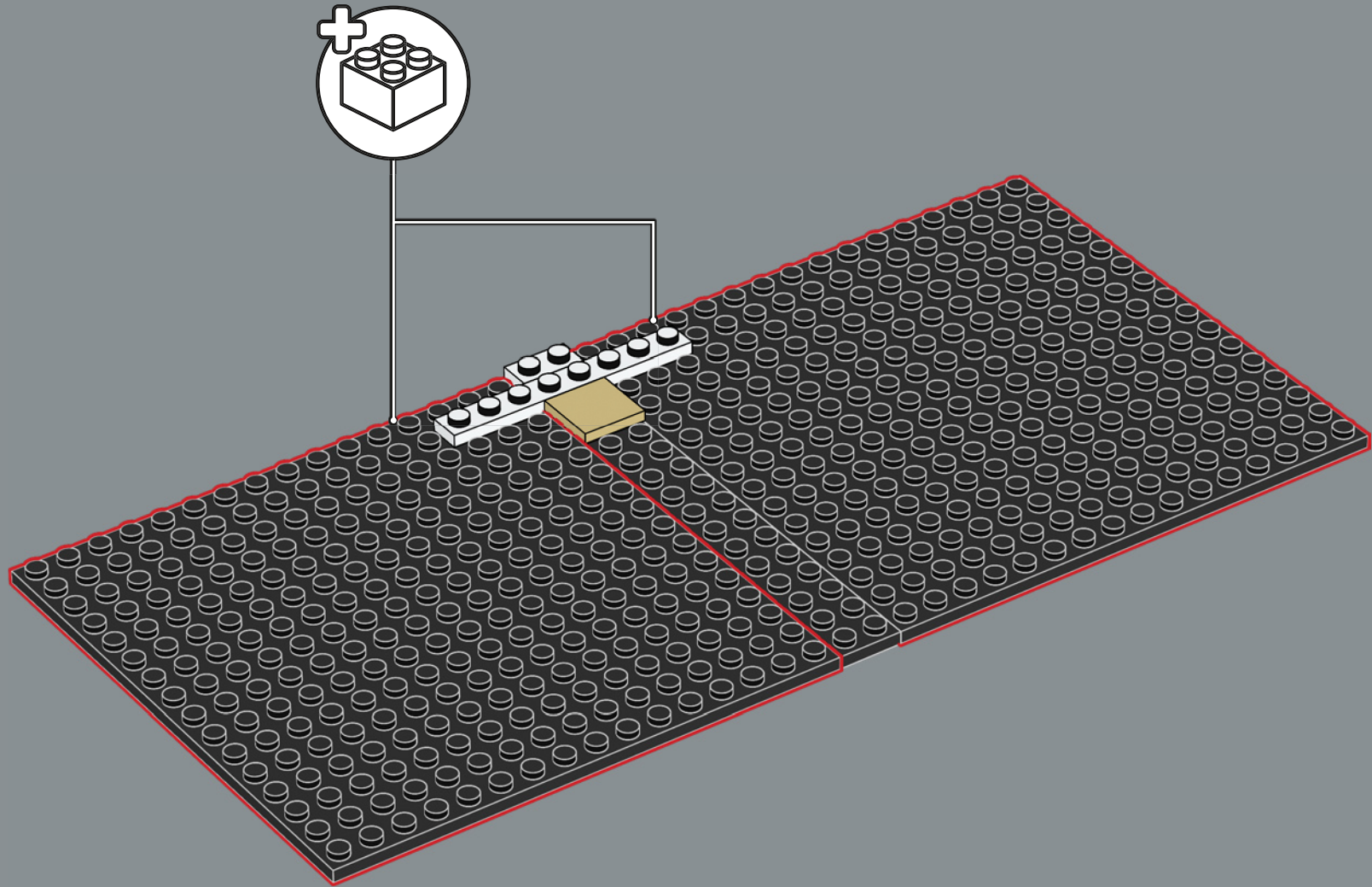

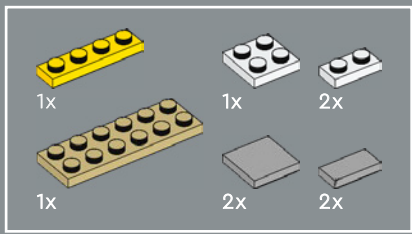

4

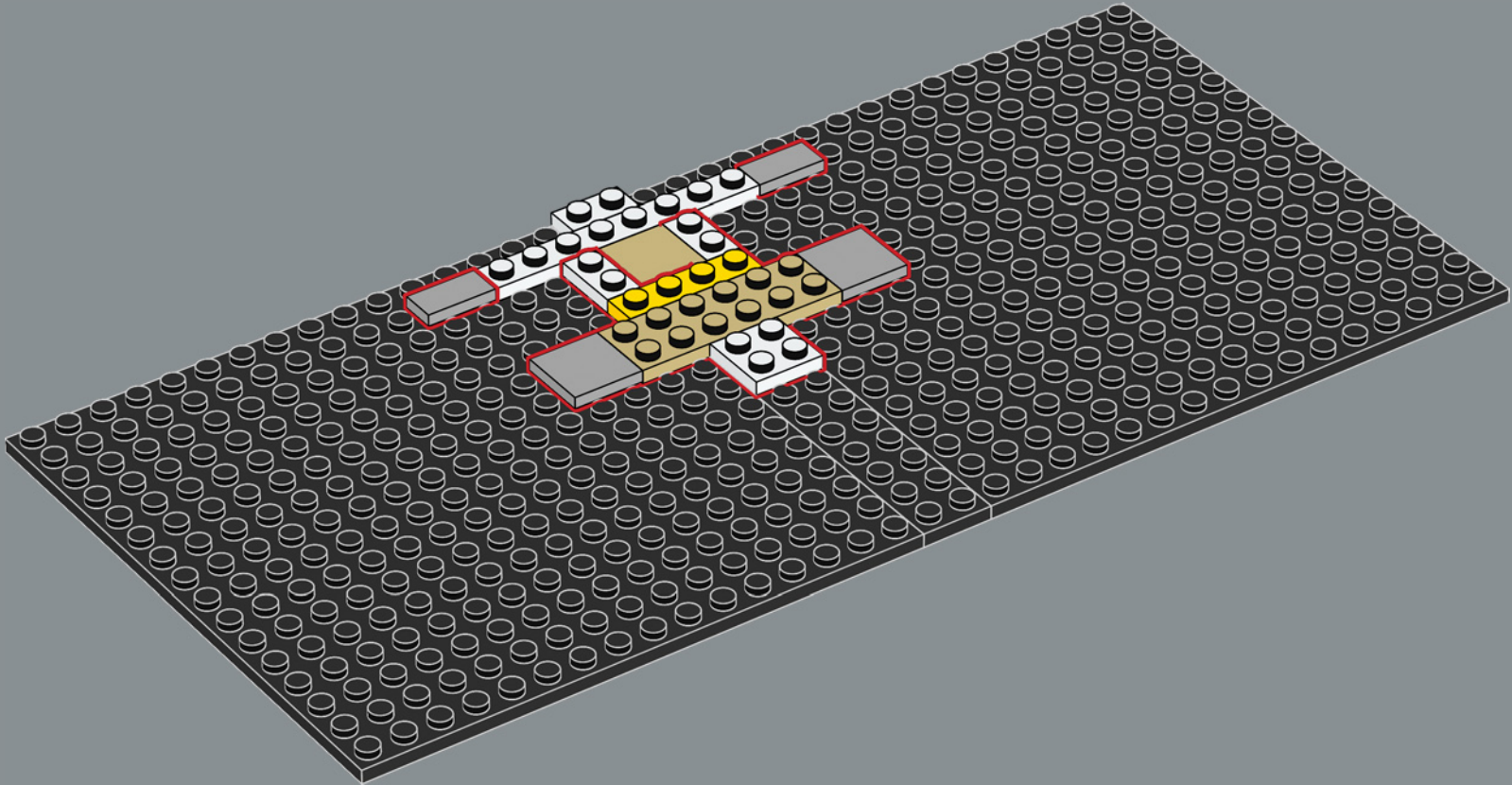

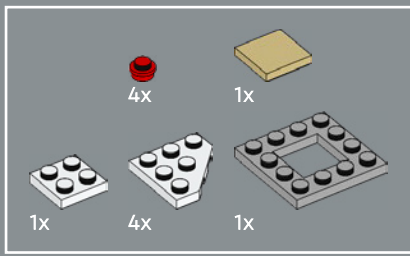

5

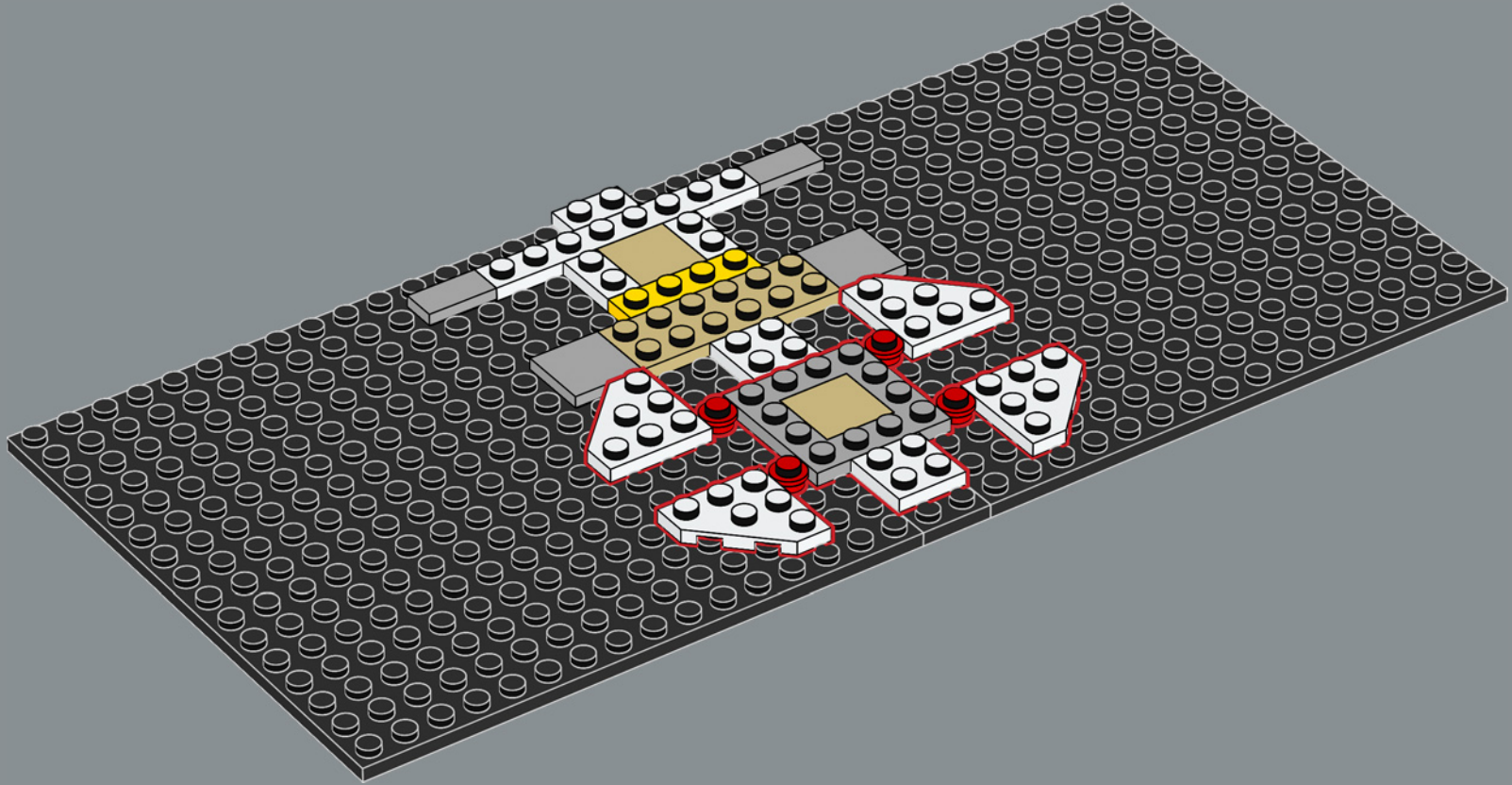

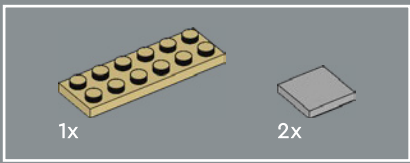

6

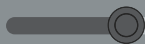
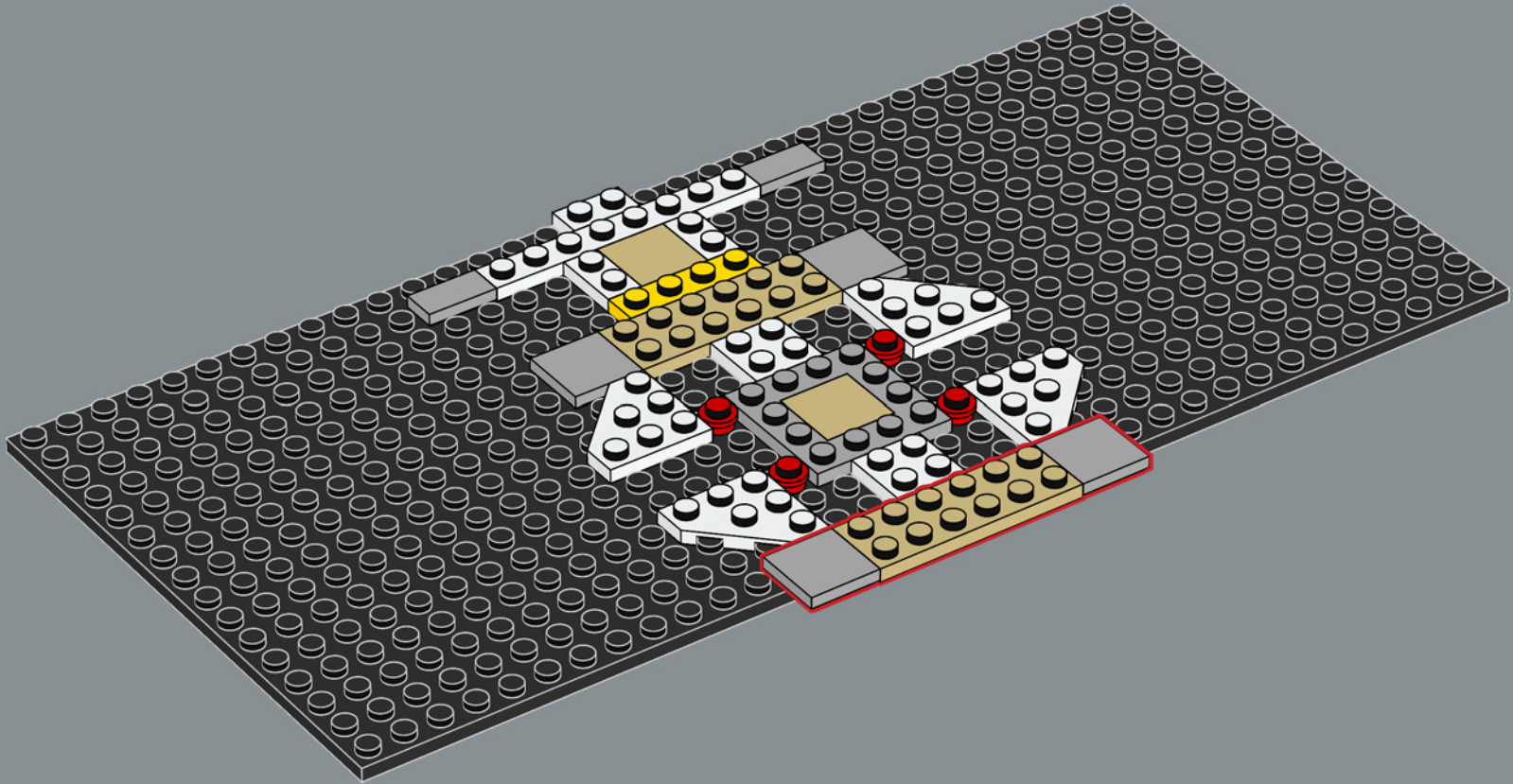

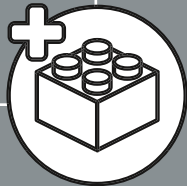
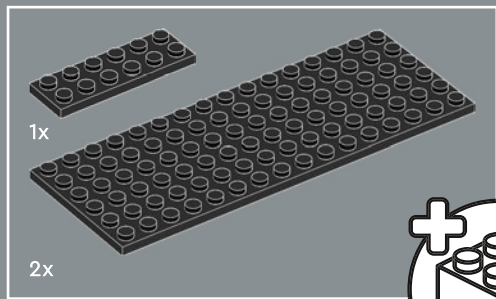

7

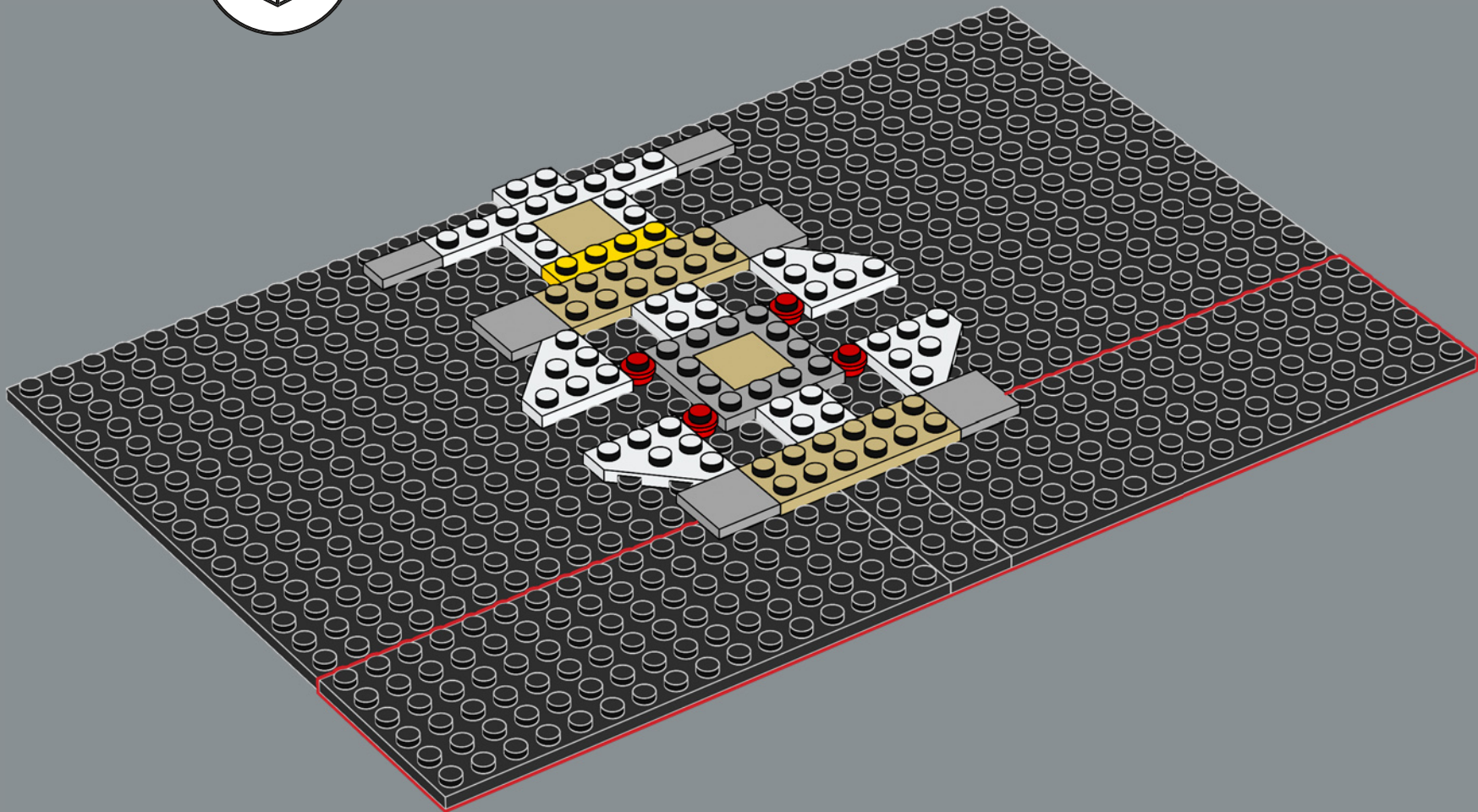

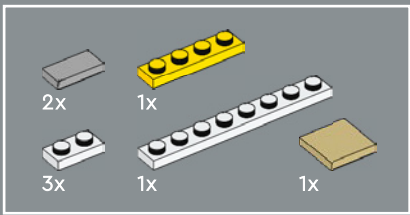

8

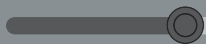
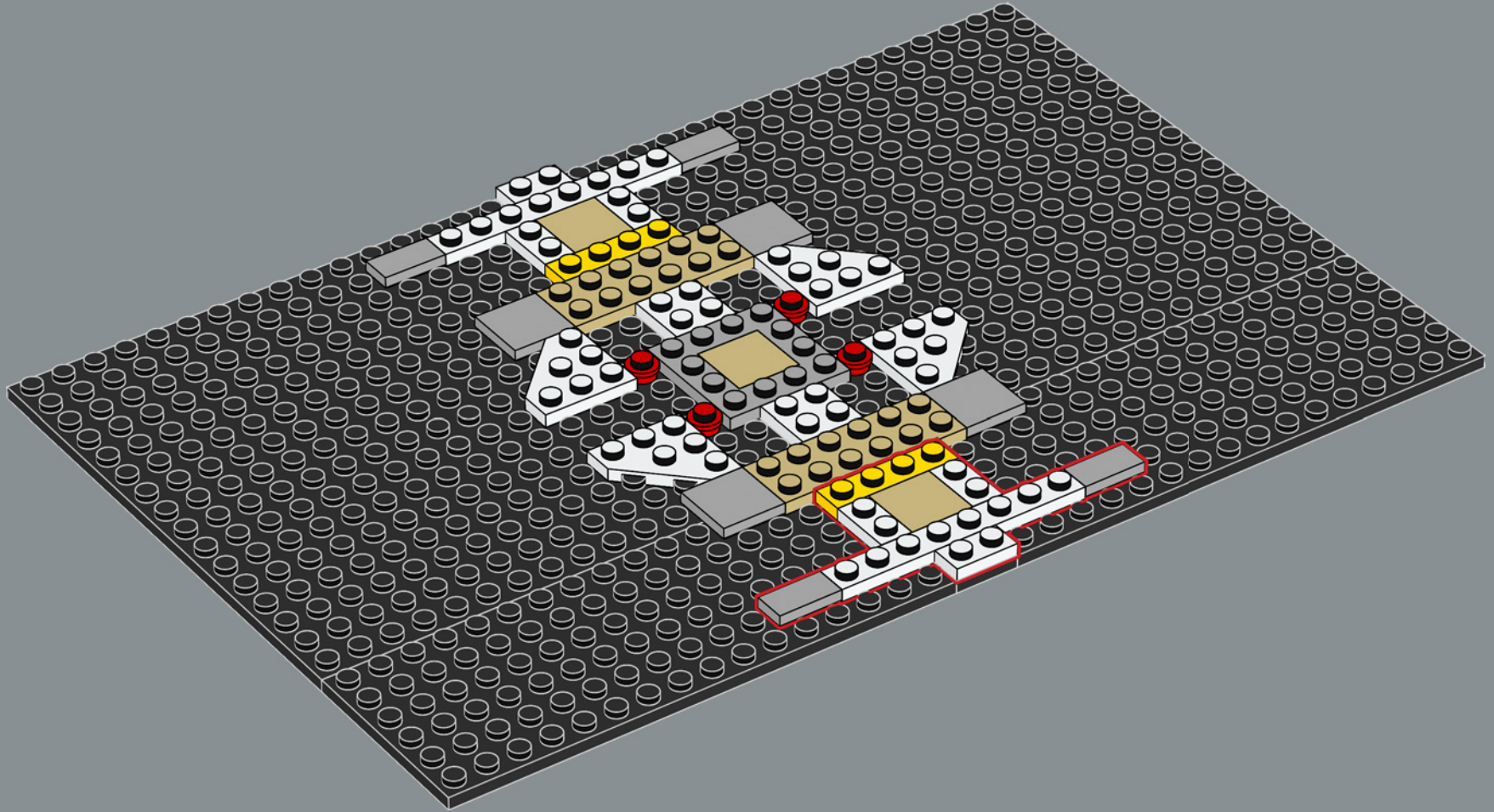

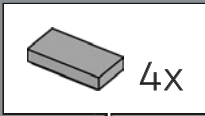
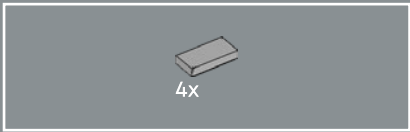

9

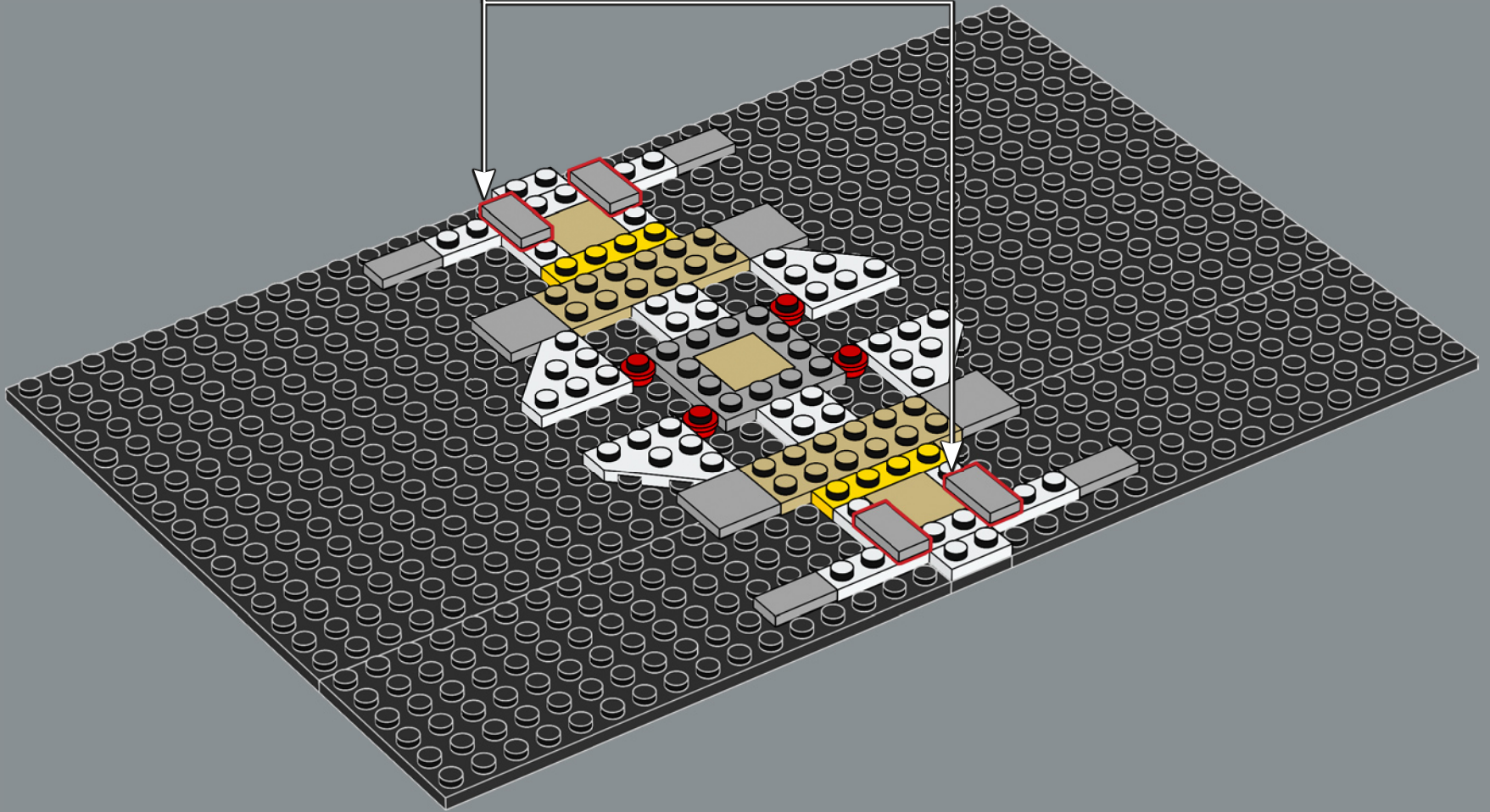

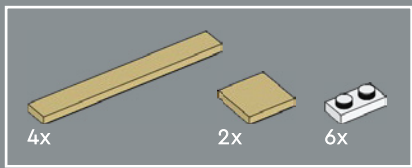

10

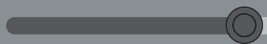
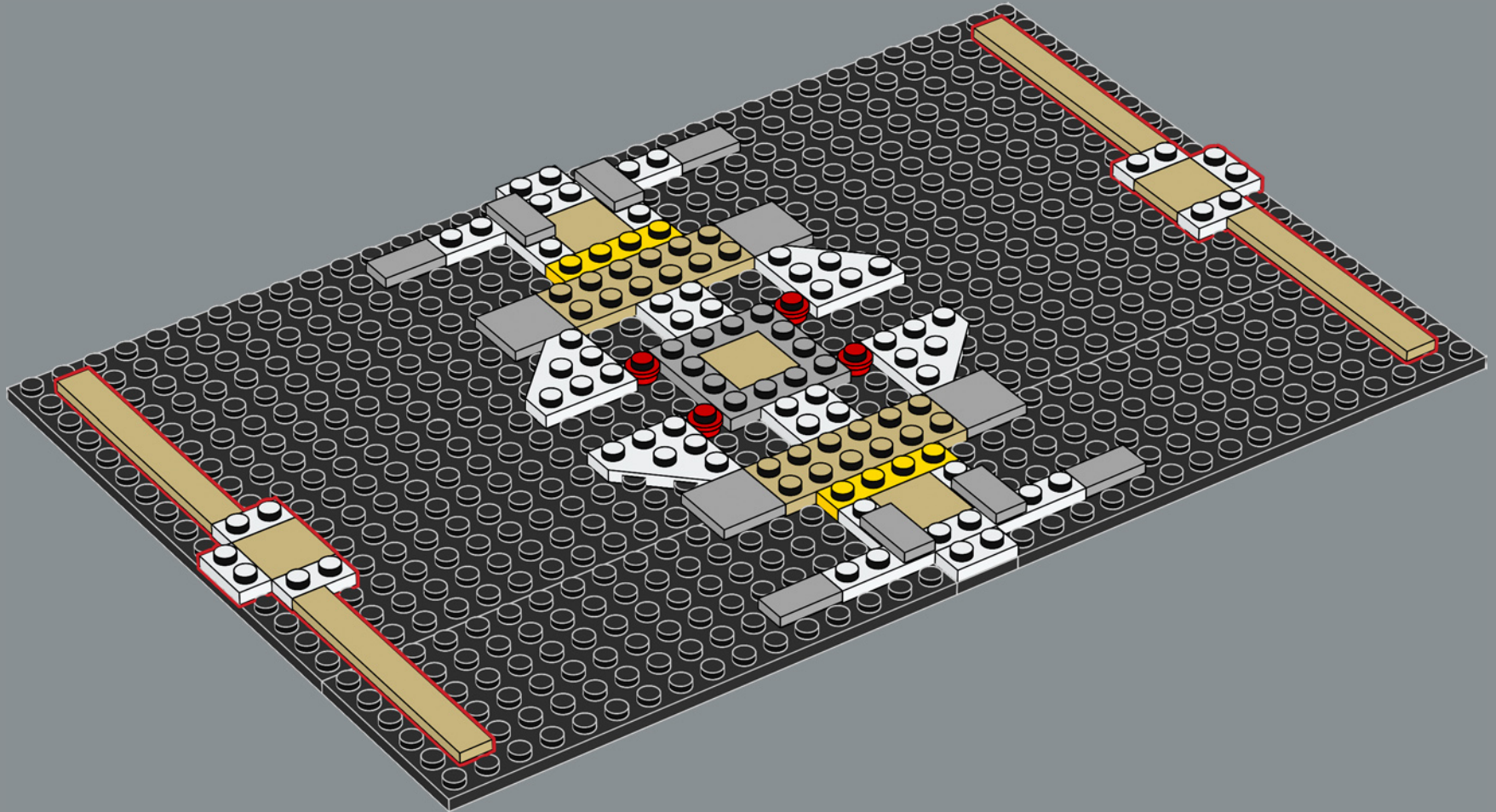

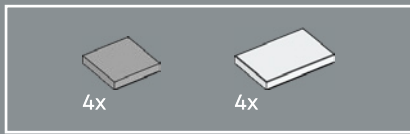

11

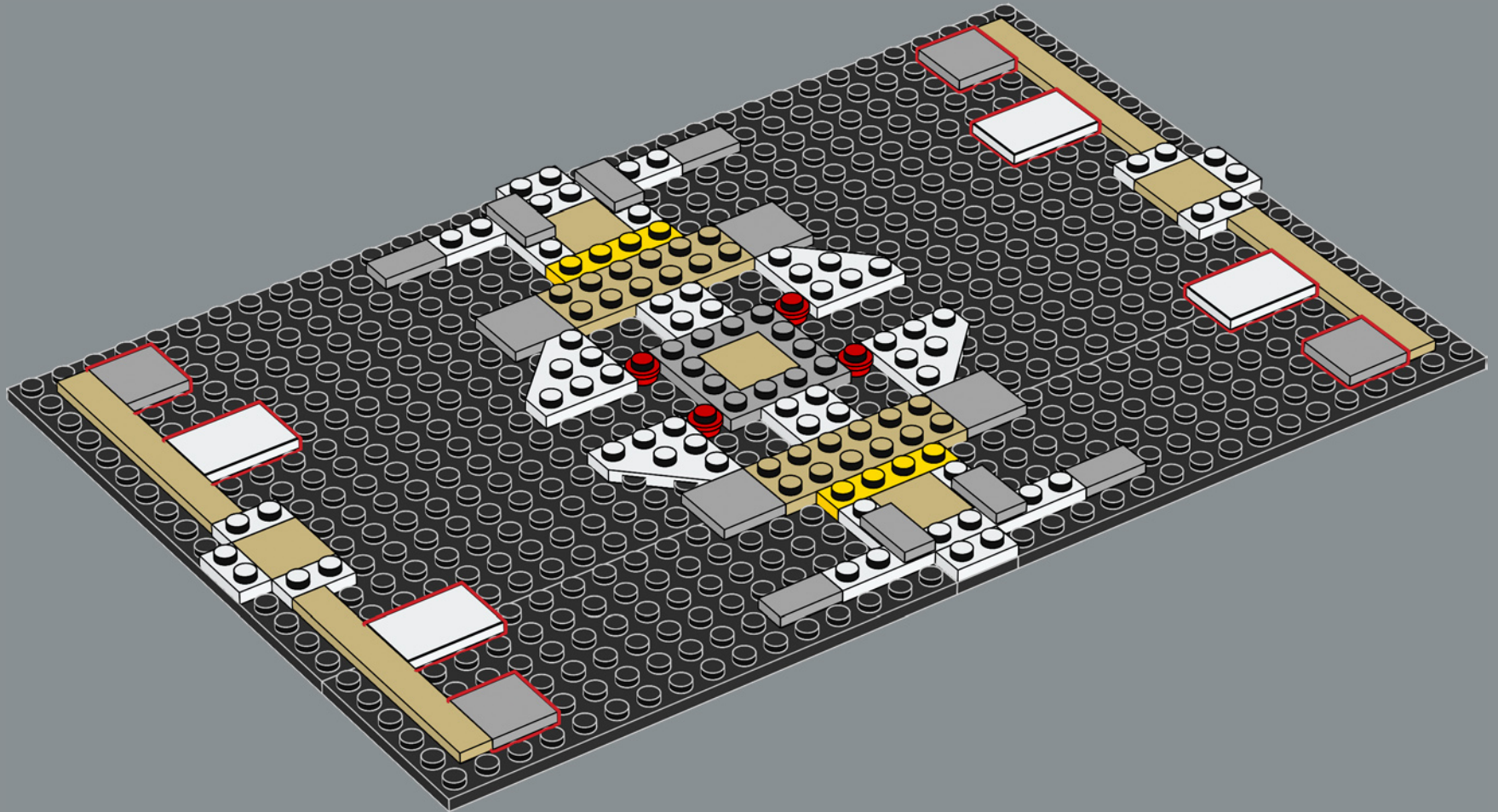

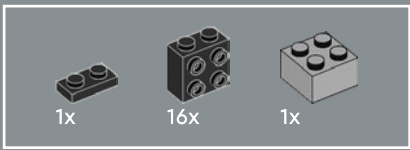

12

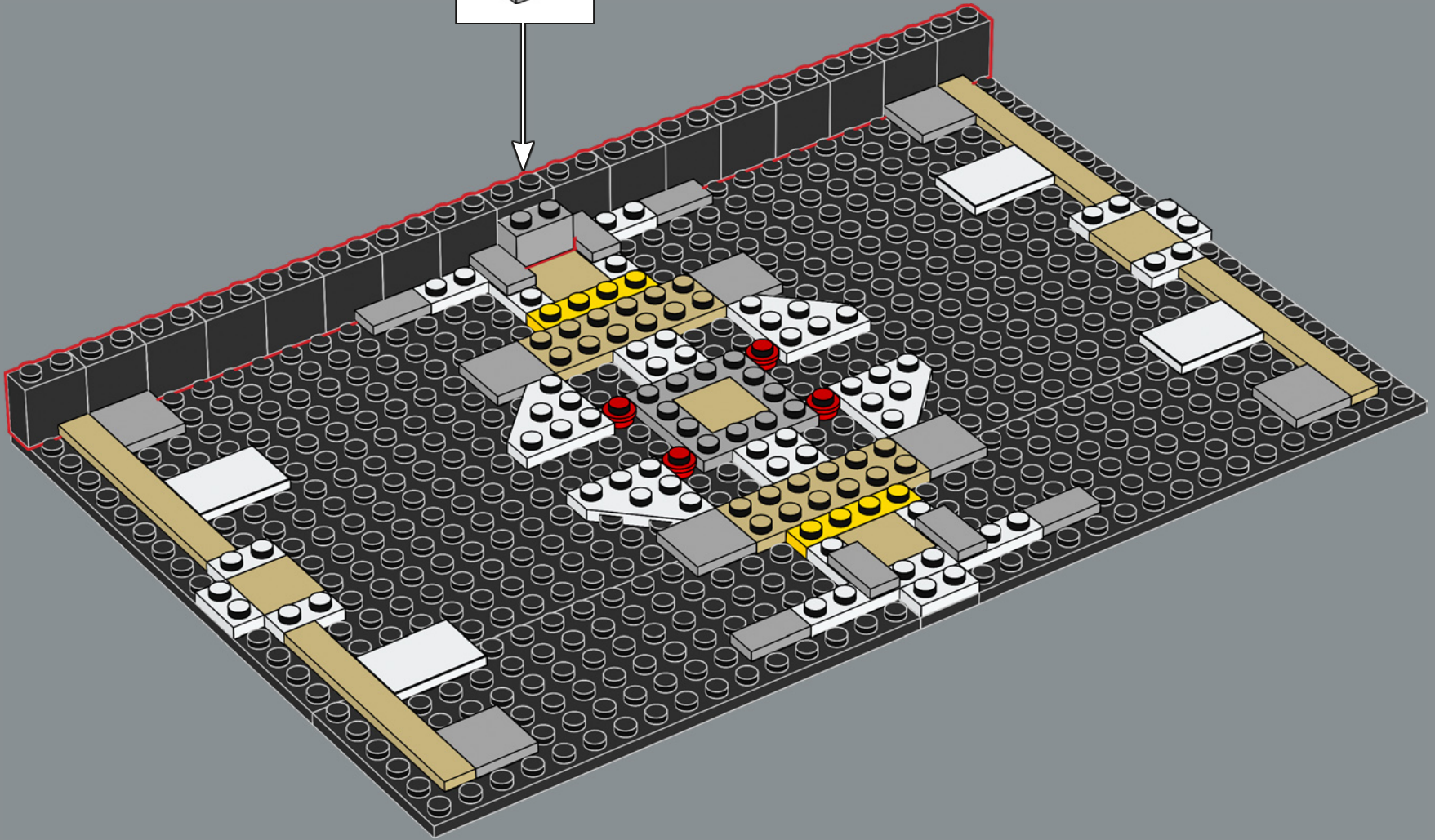
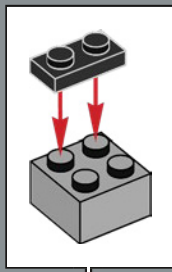

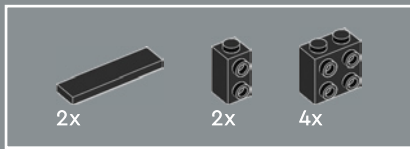

13

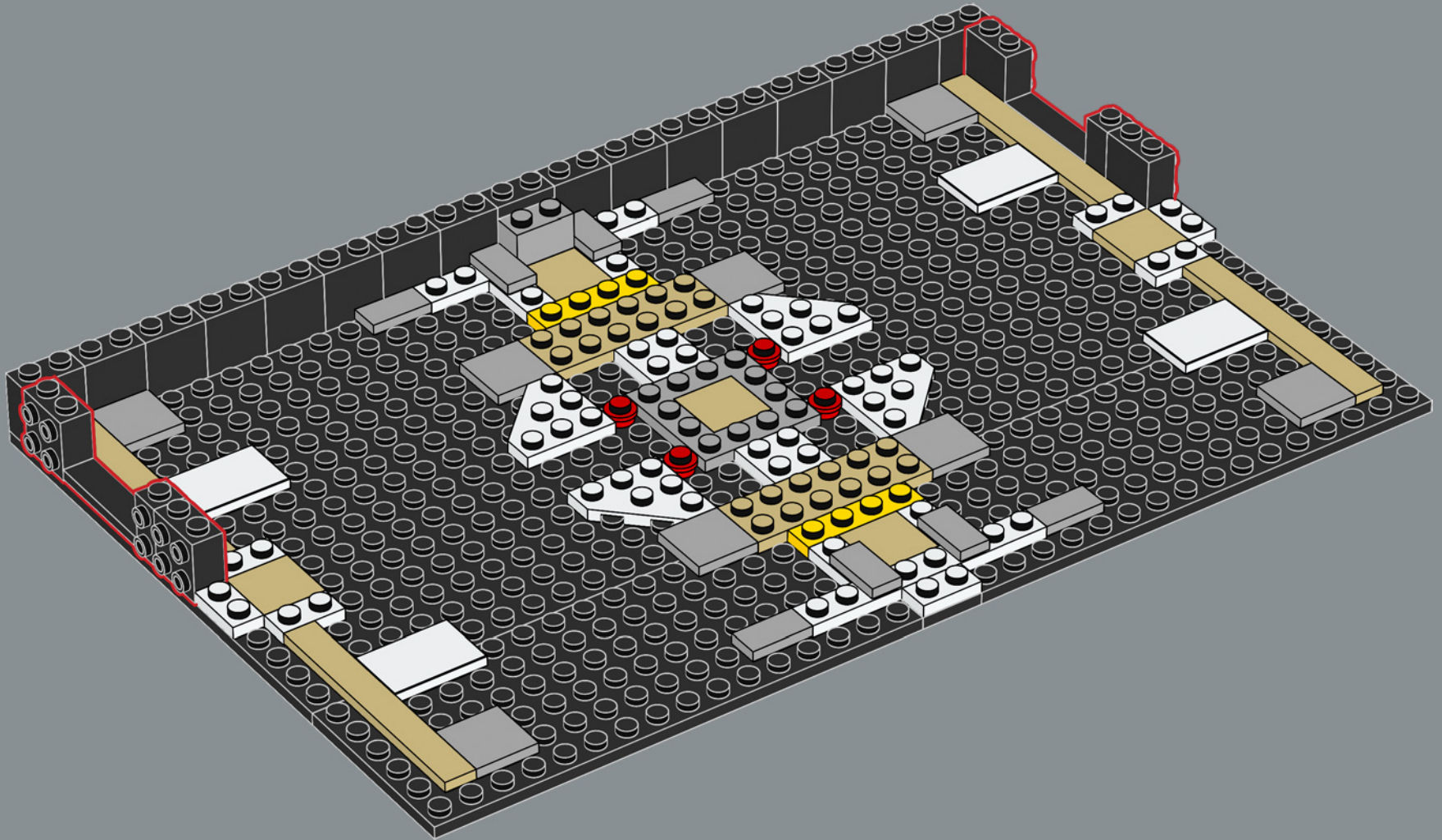

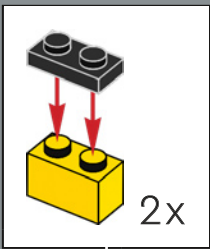
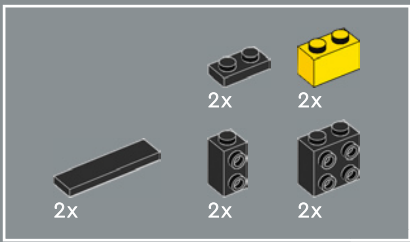

14

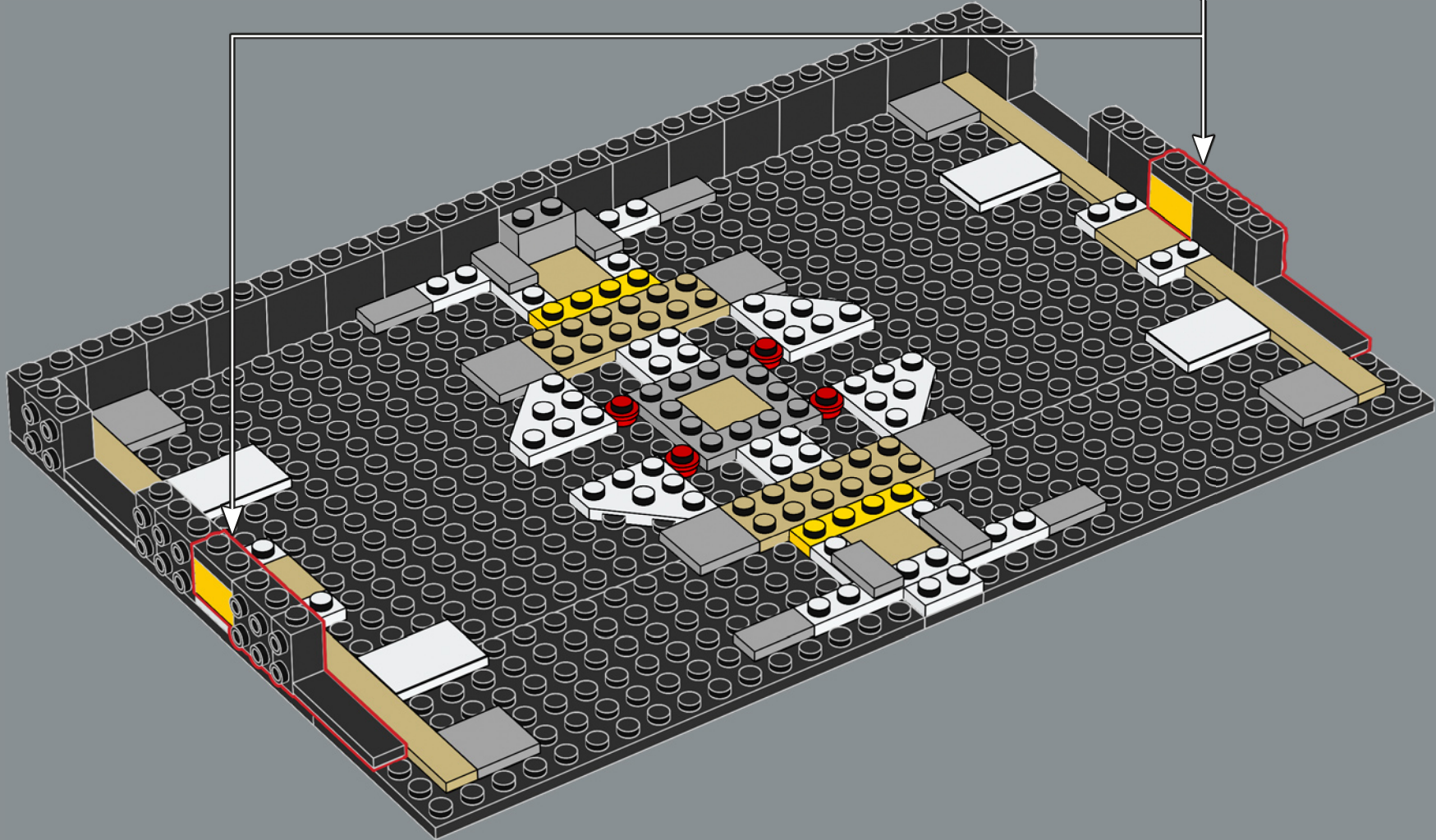

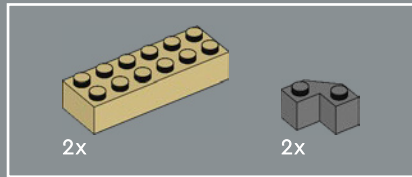

15

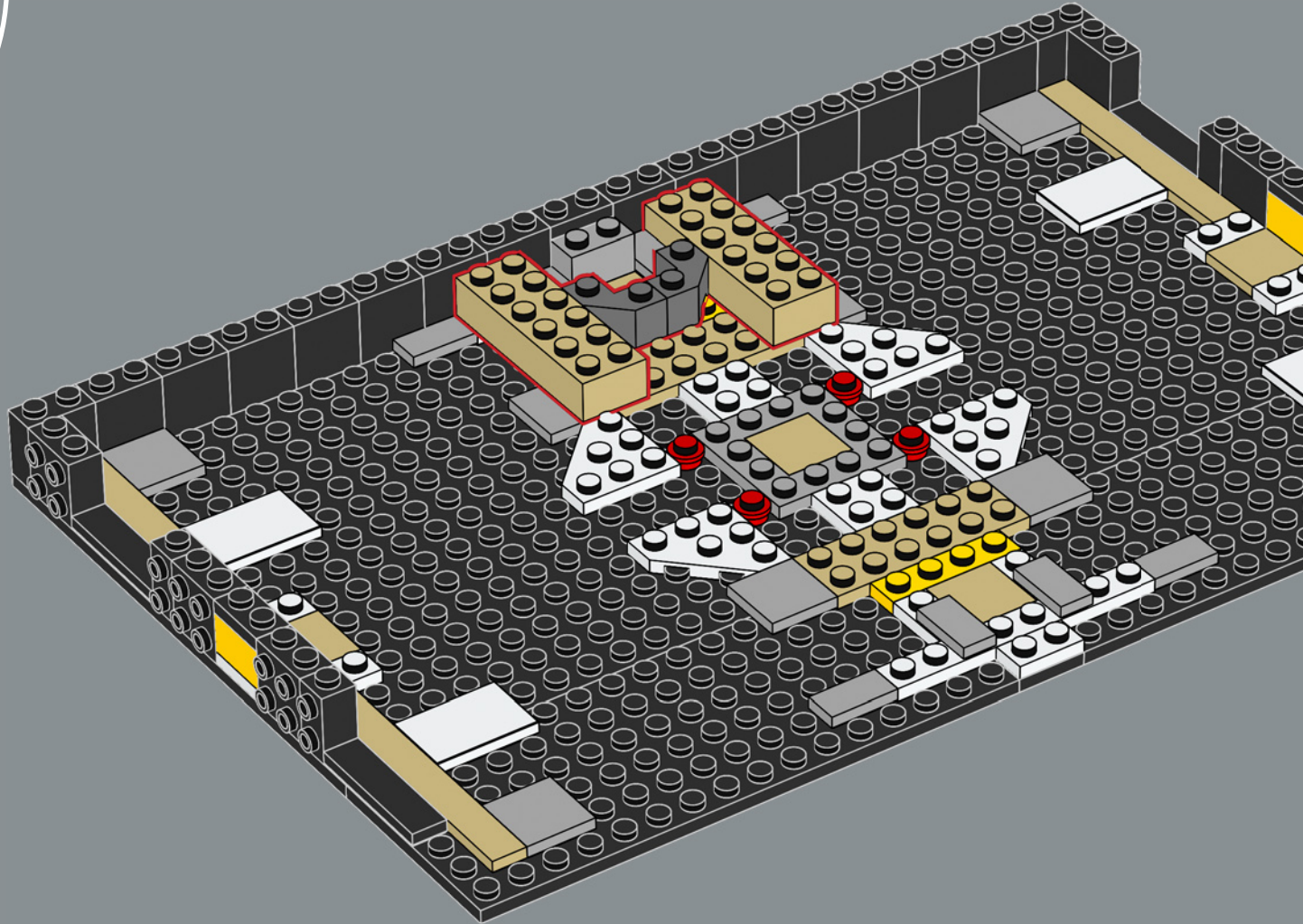

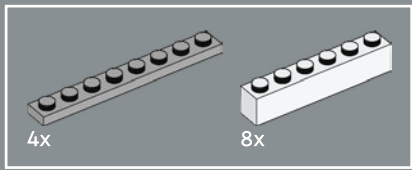

16

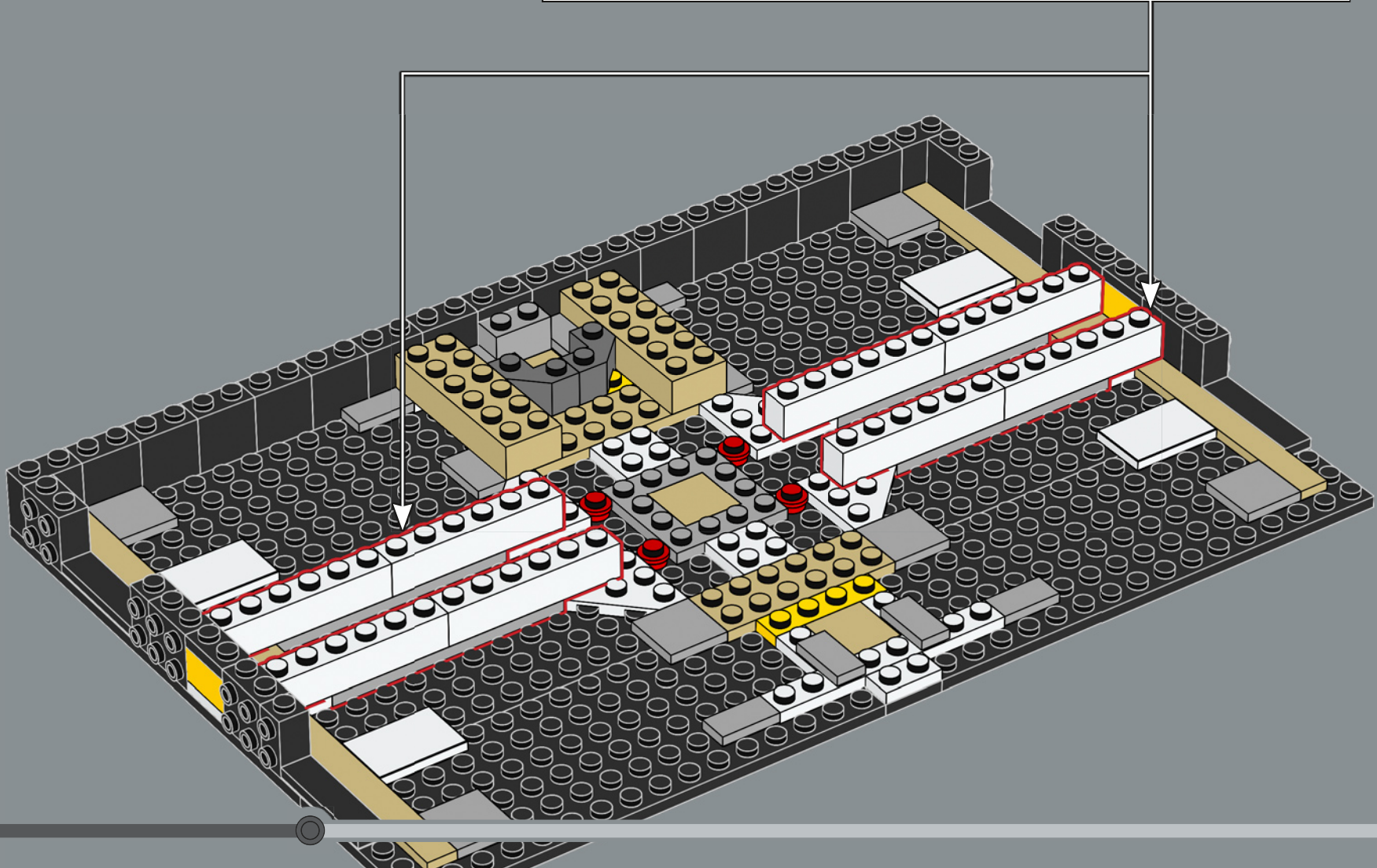
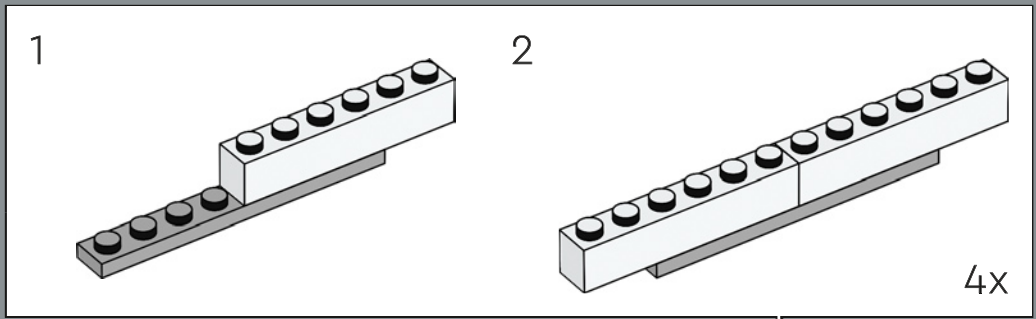

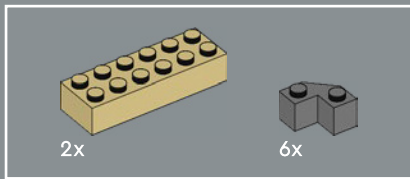

17

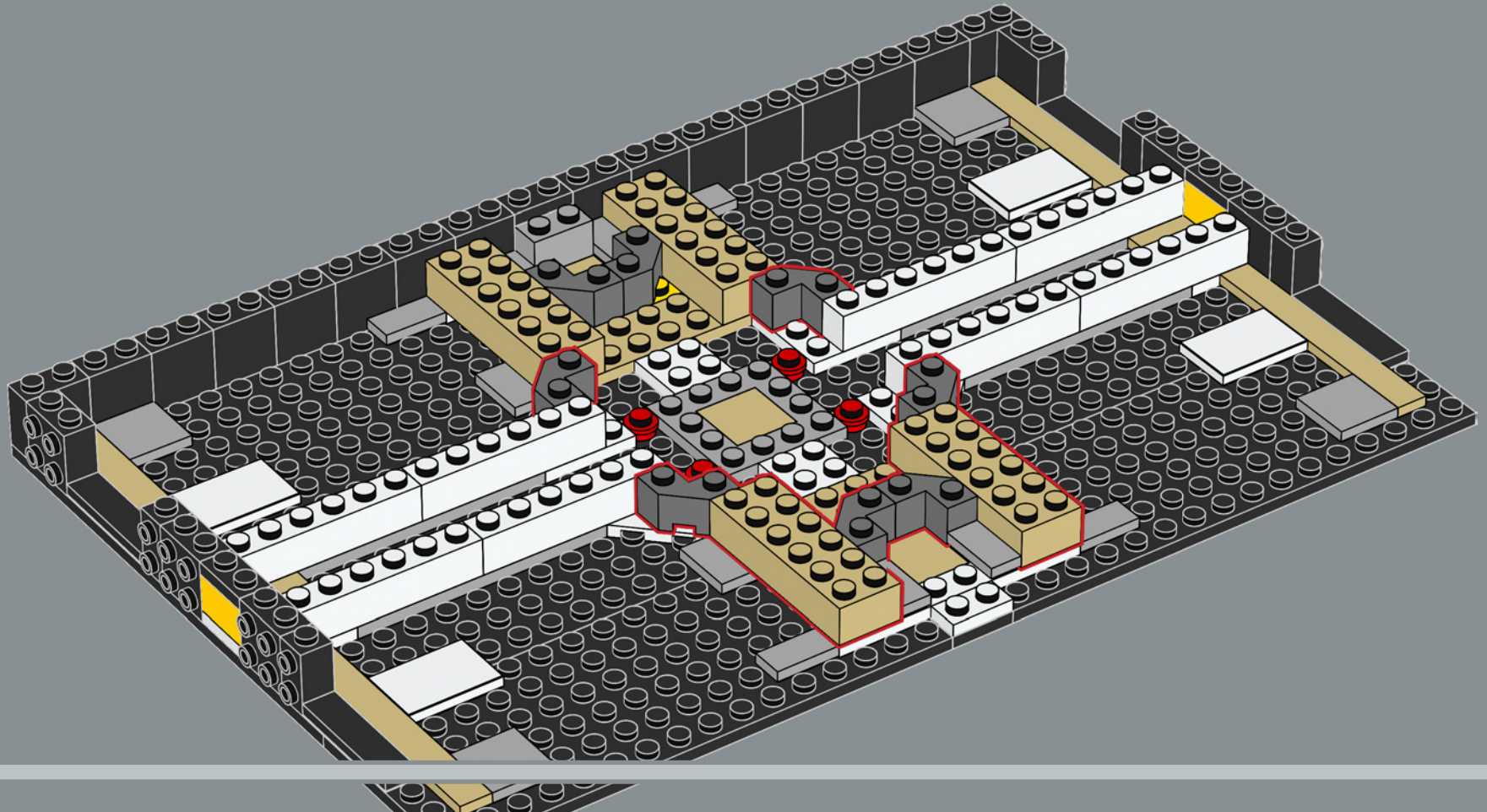

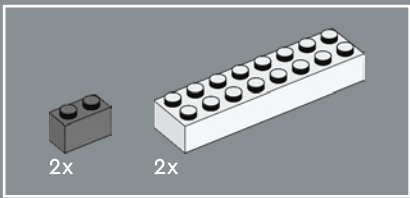

18

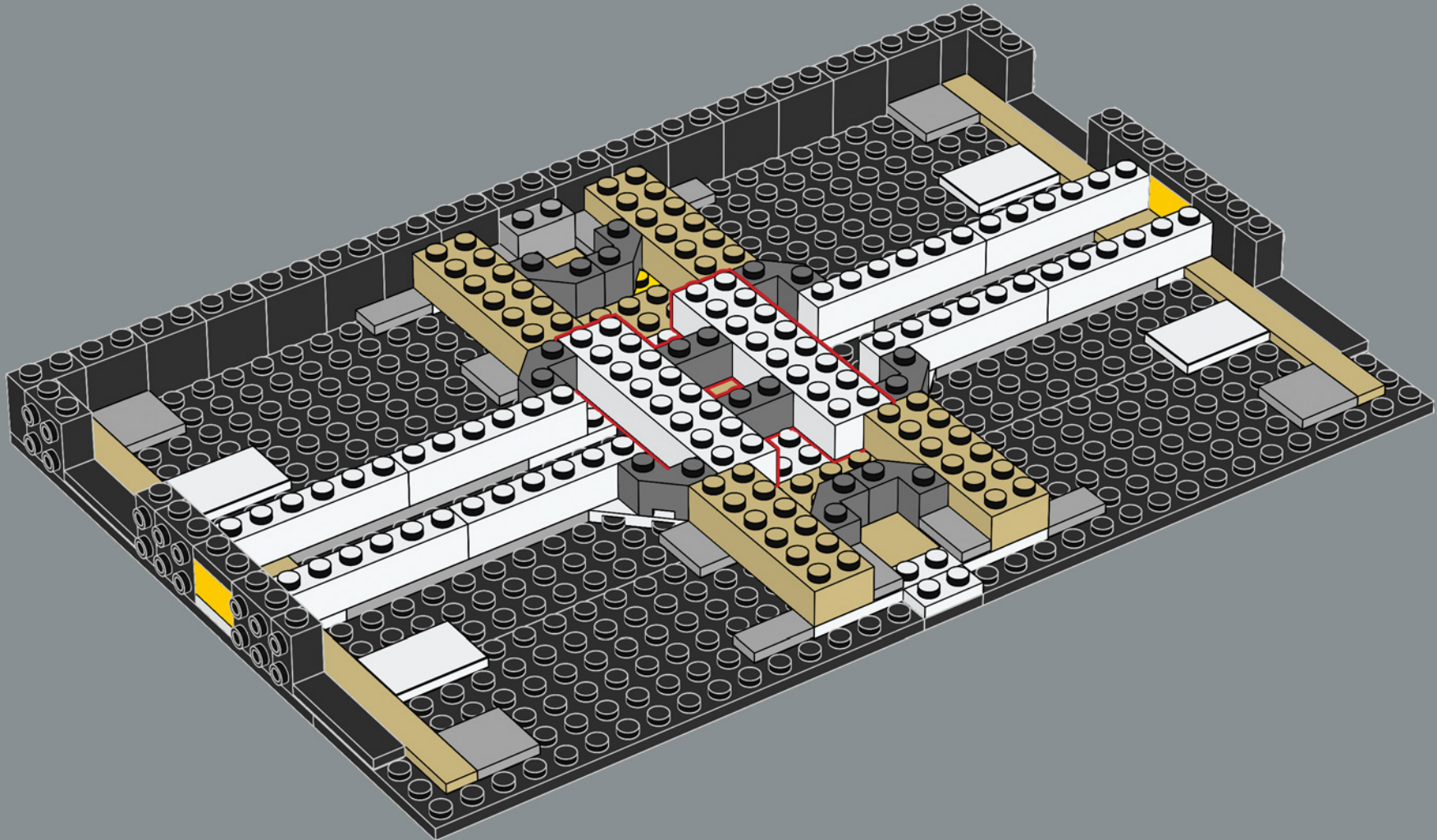

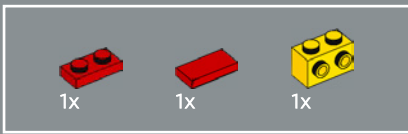

19

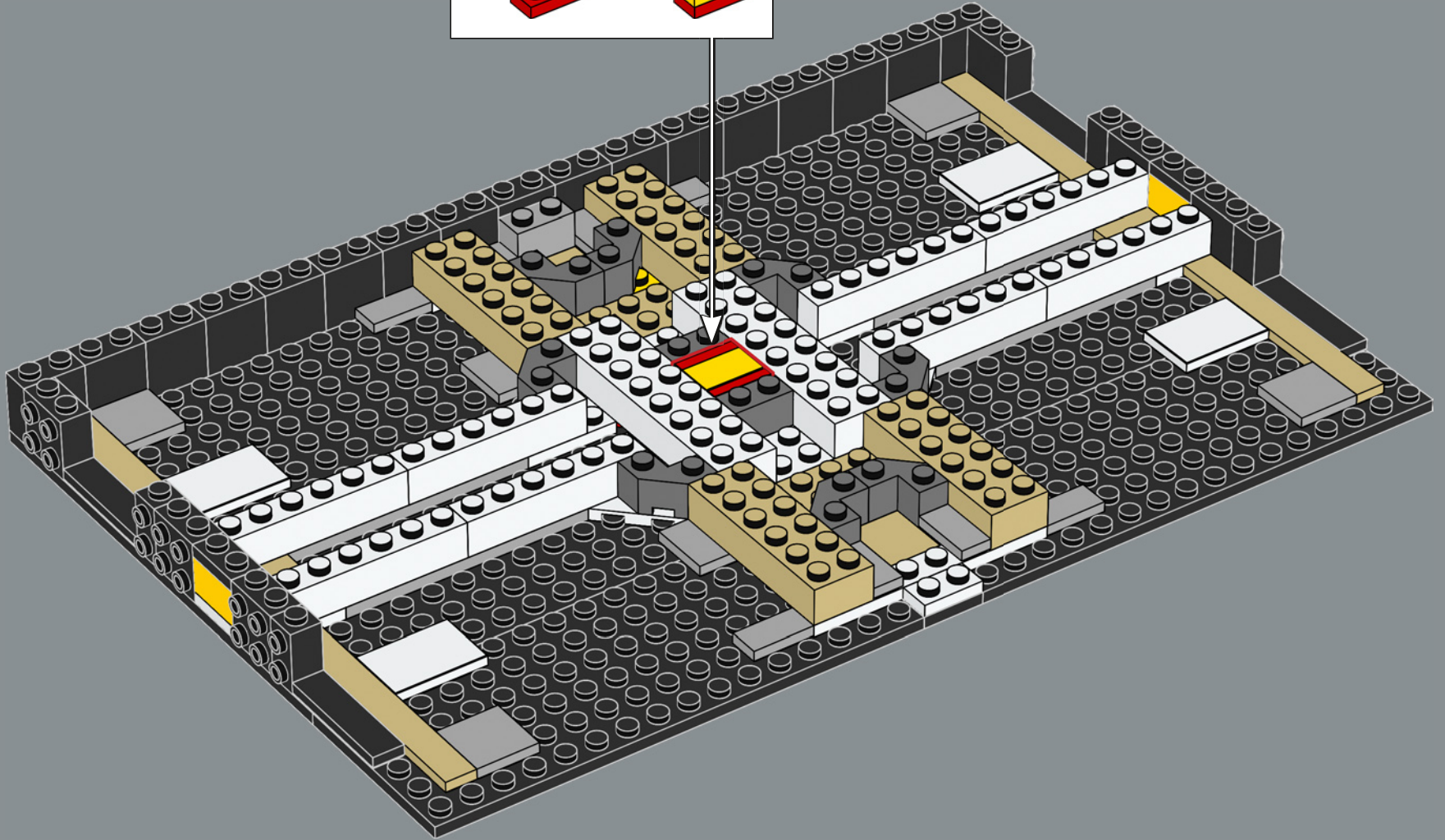
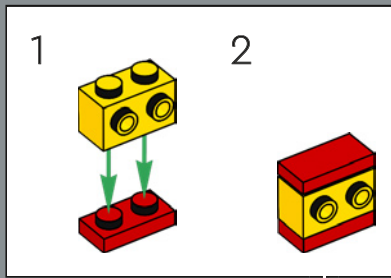

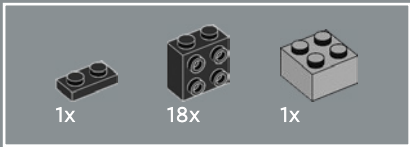

20

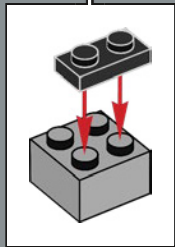
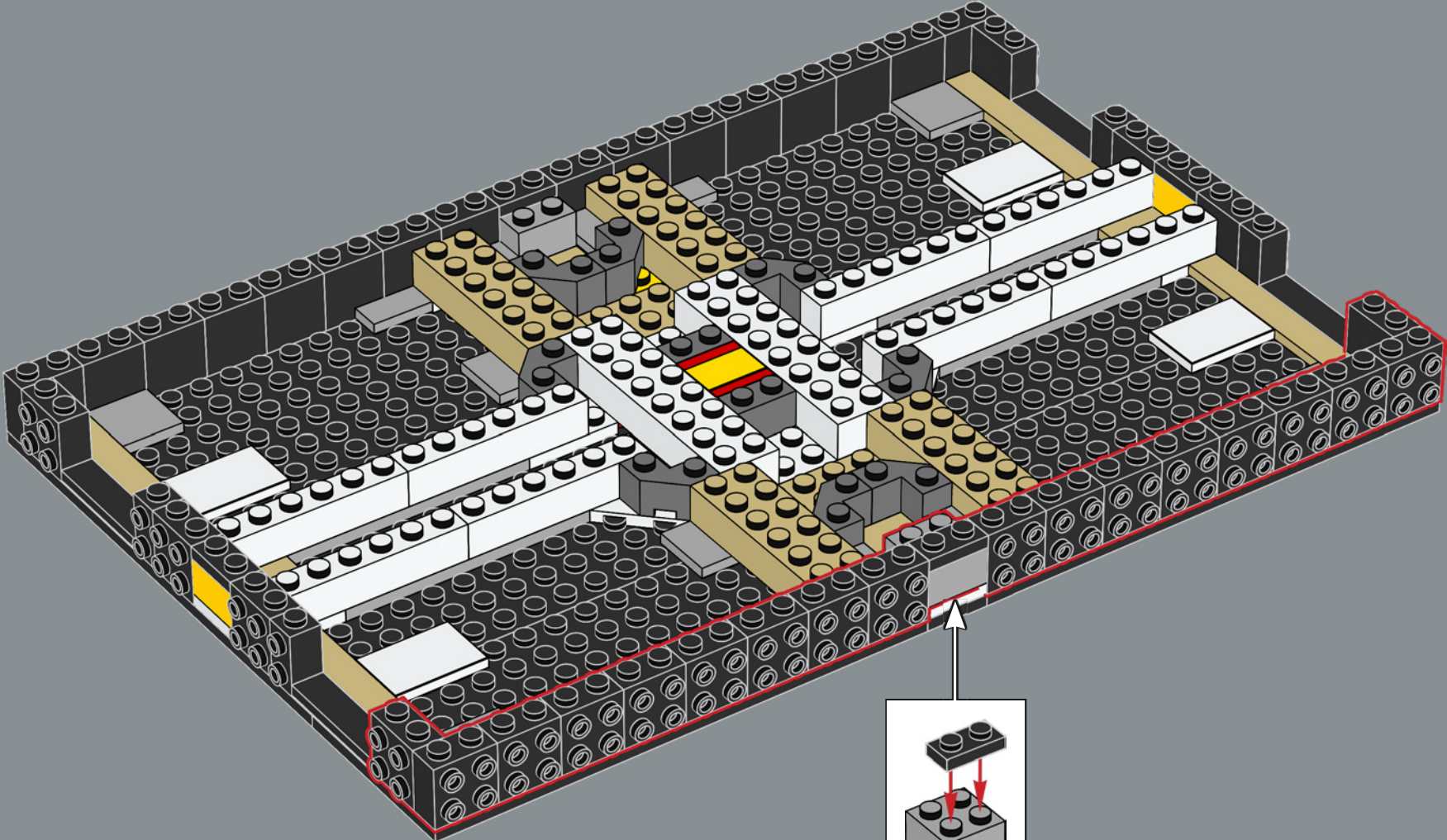

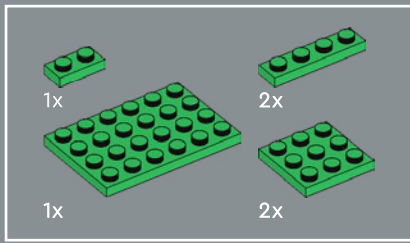

21

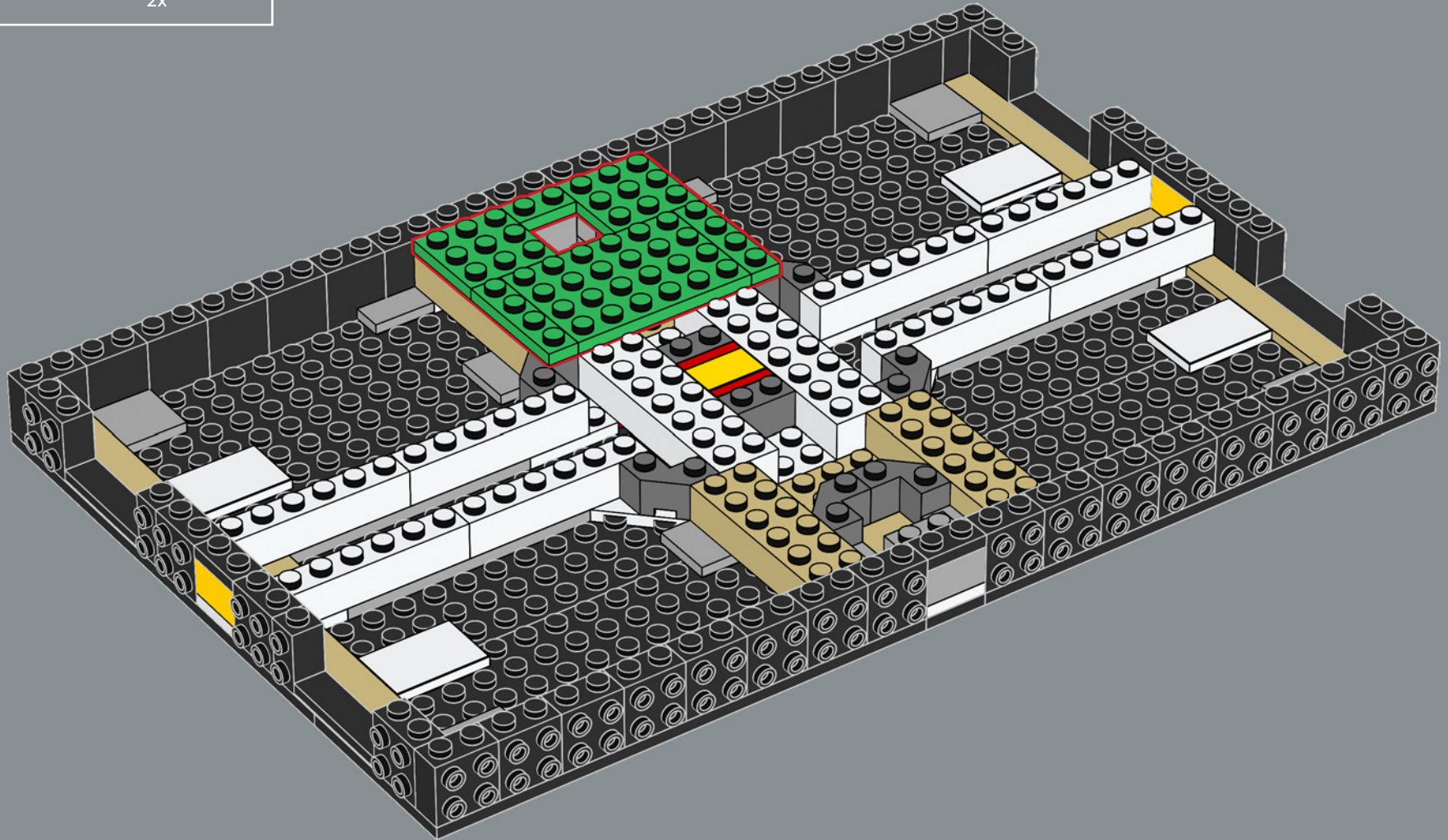

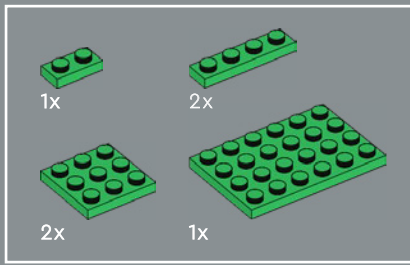

23

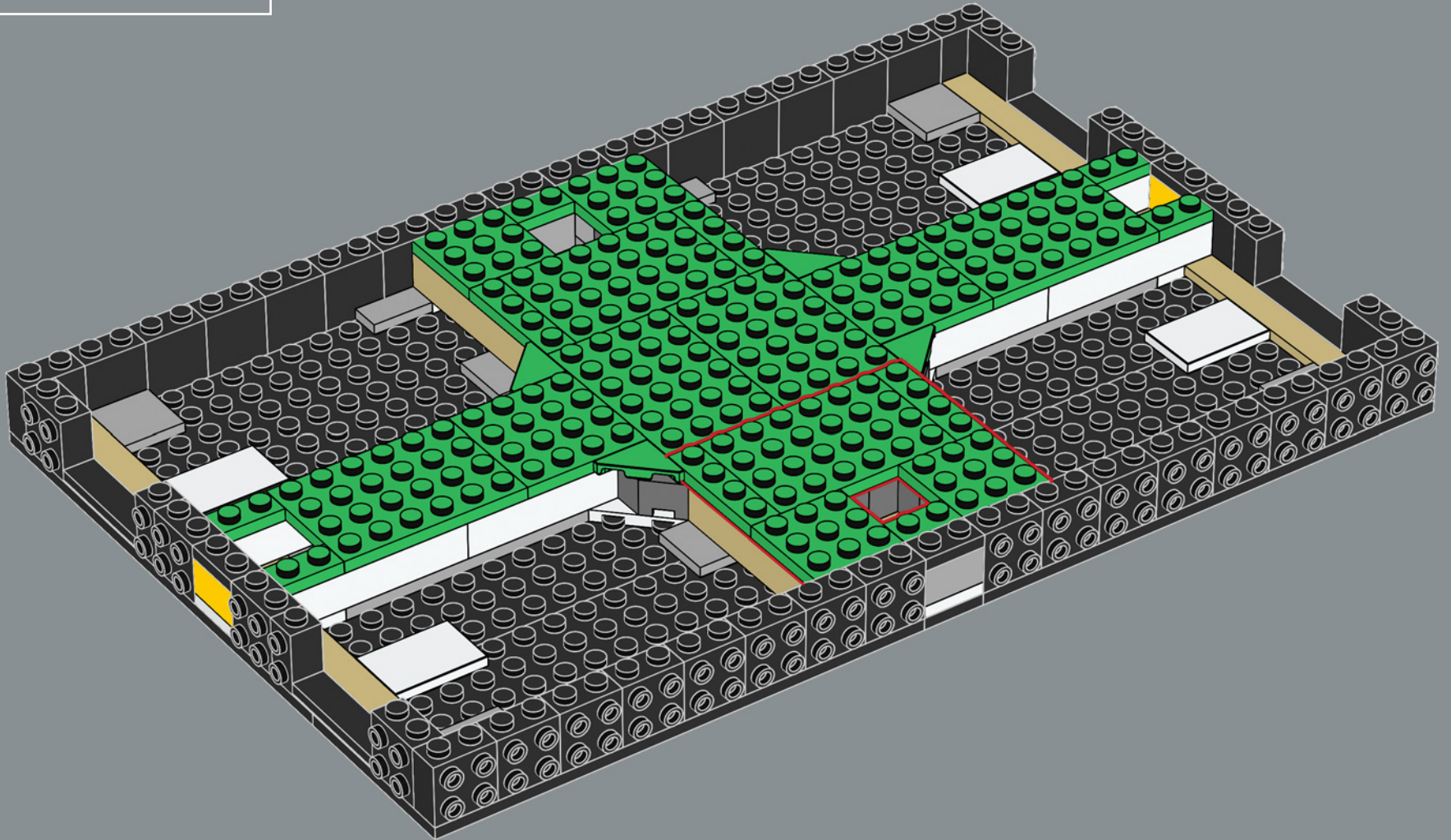



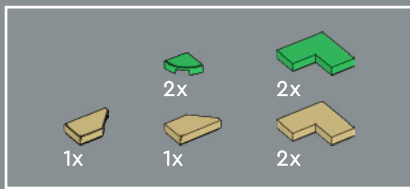

24

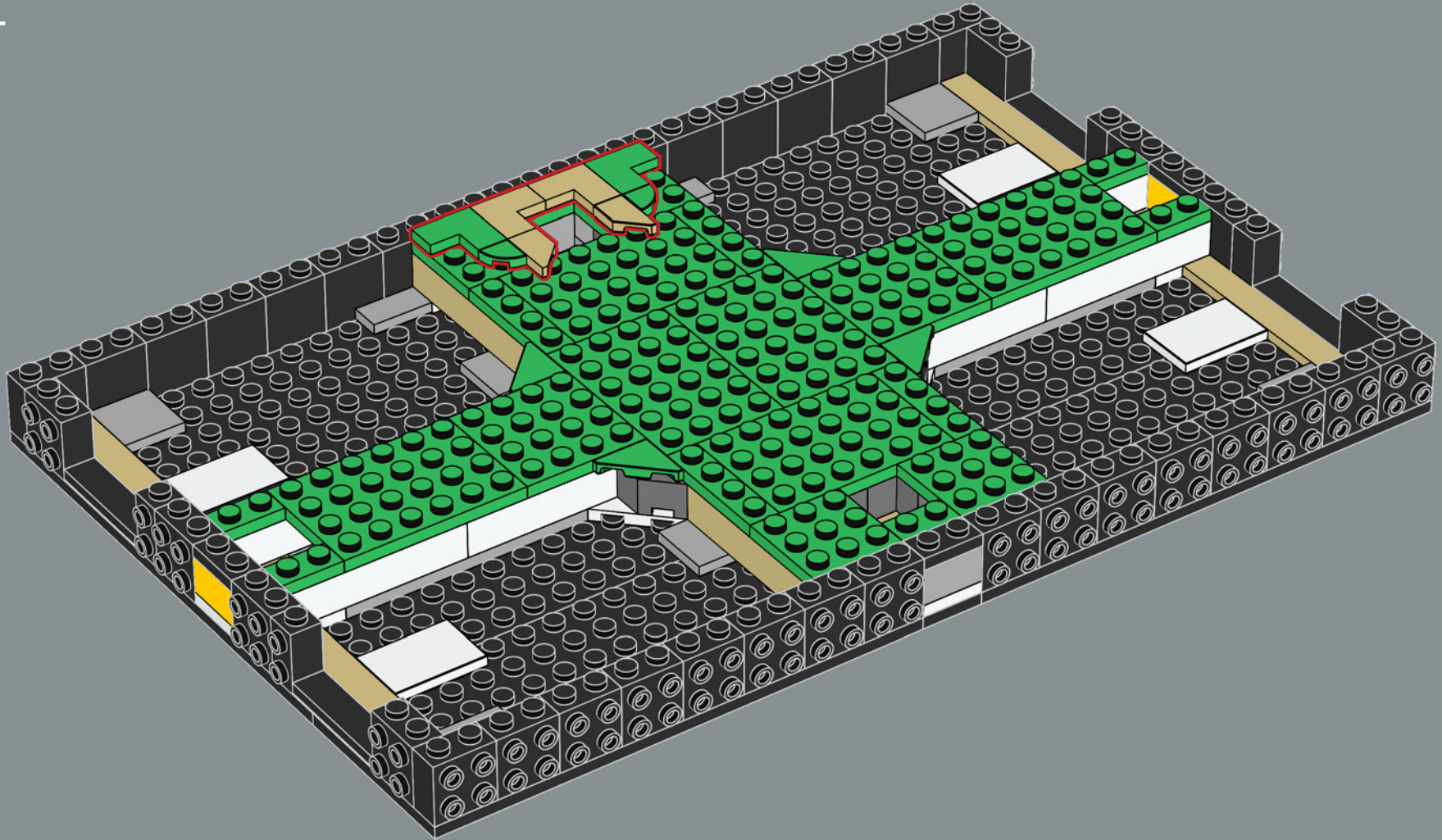



25

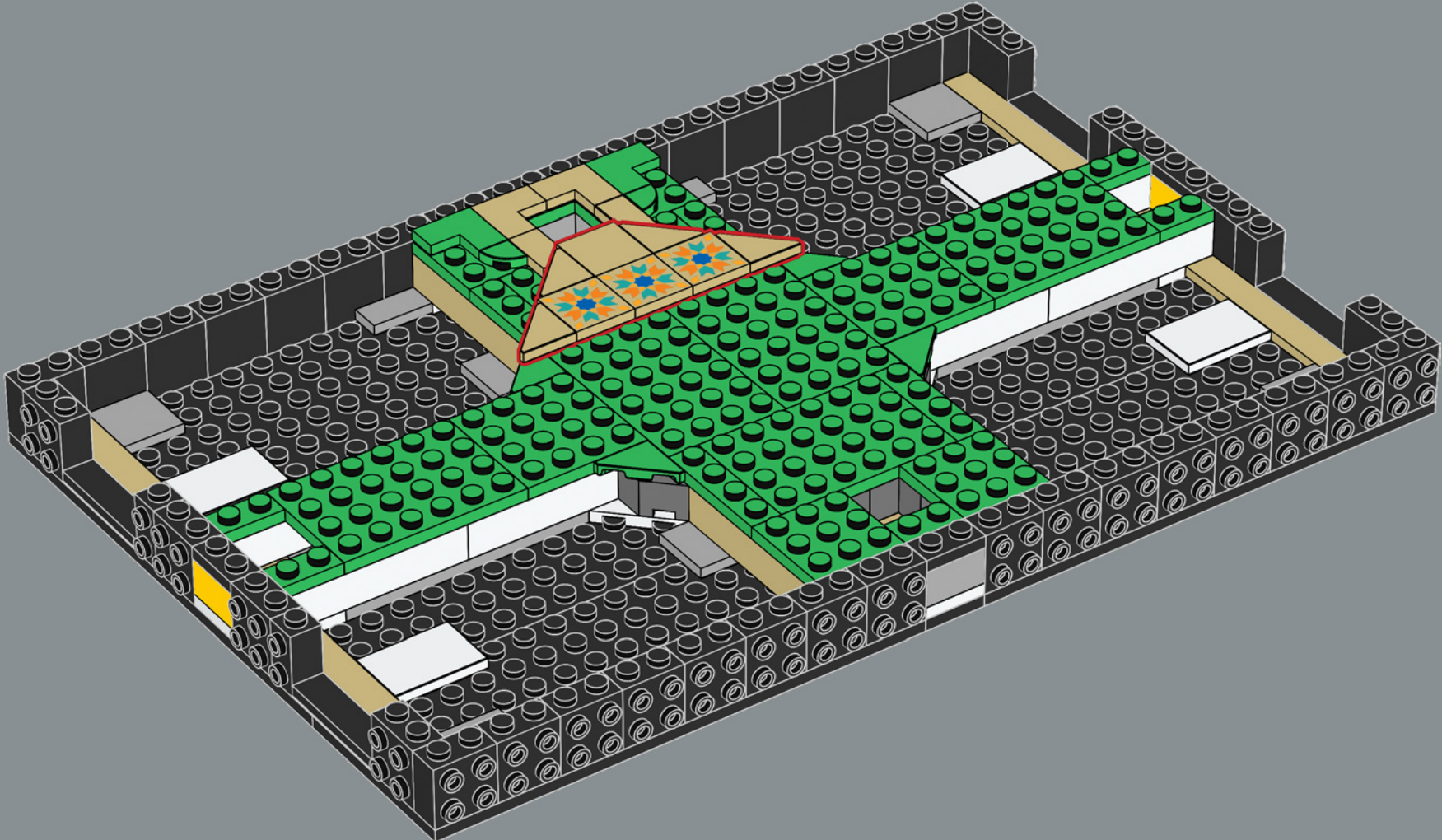

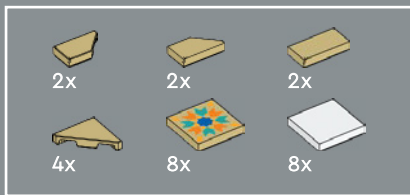

26

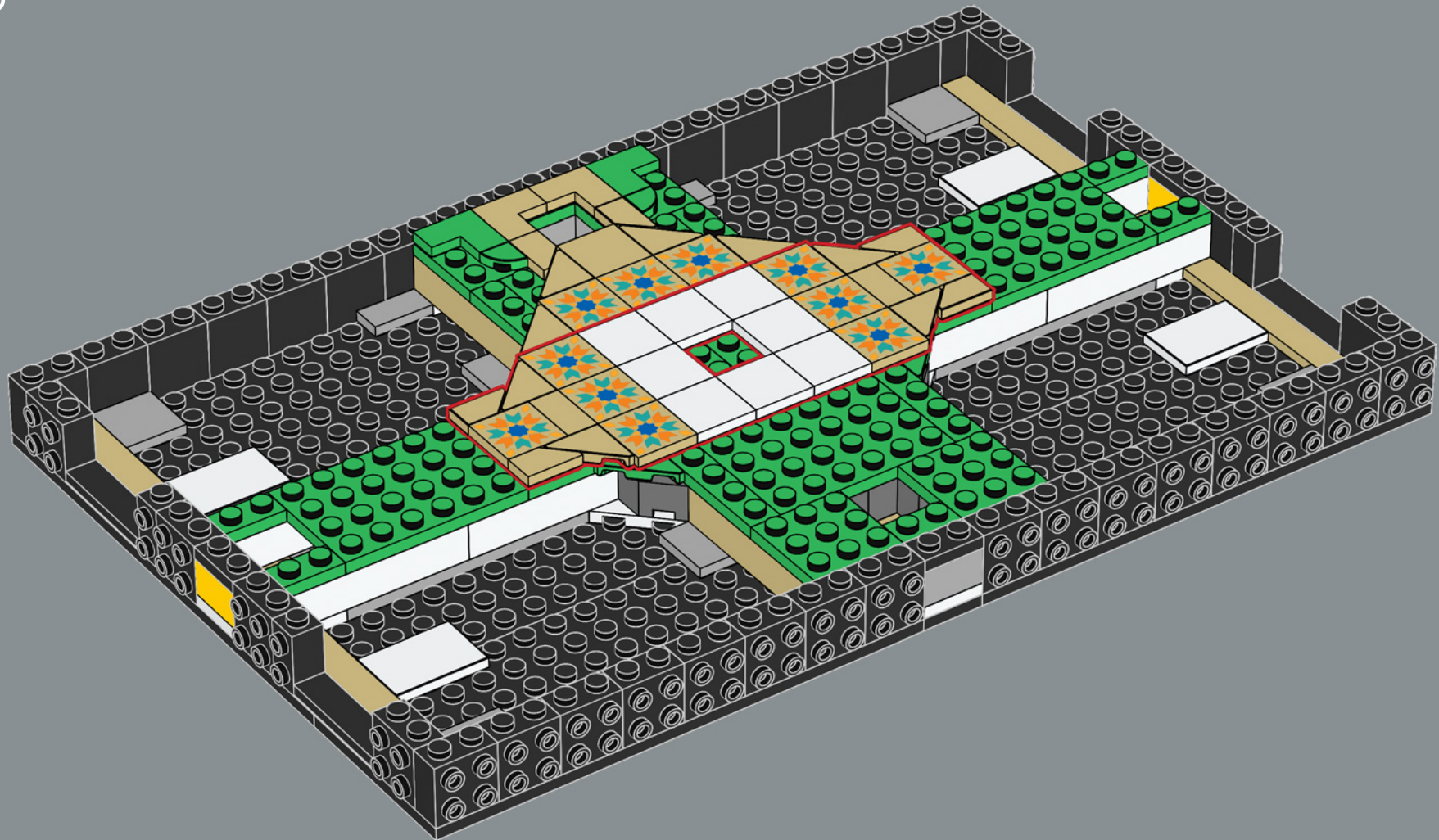

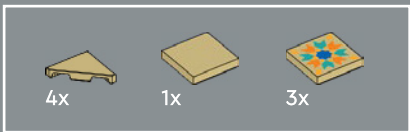

27

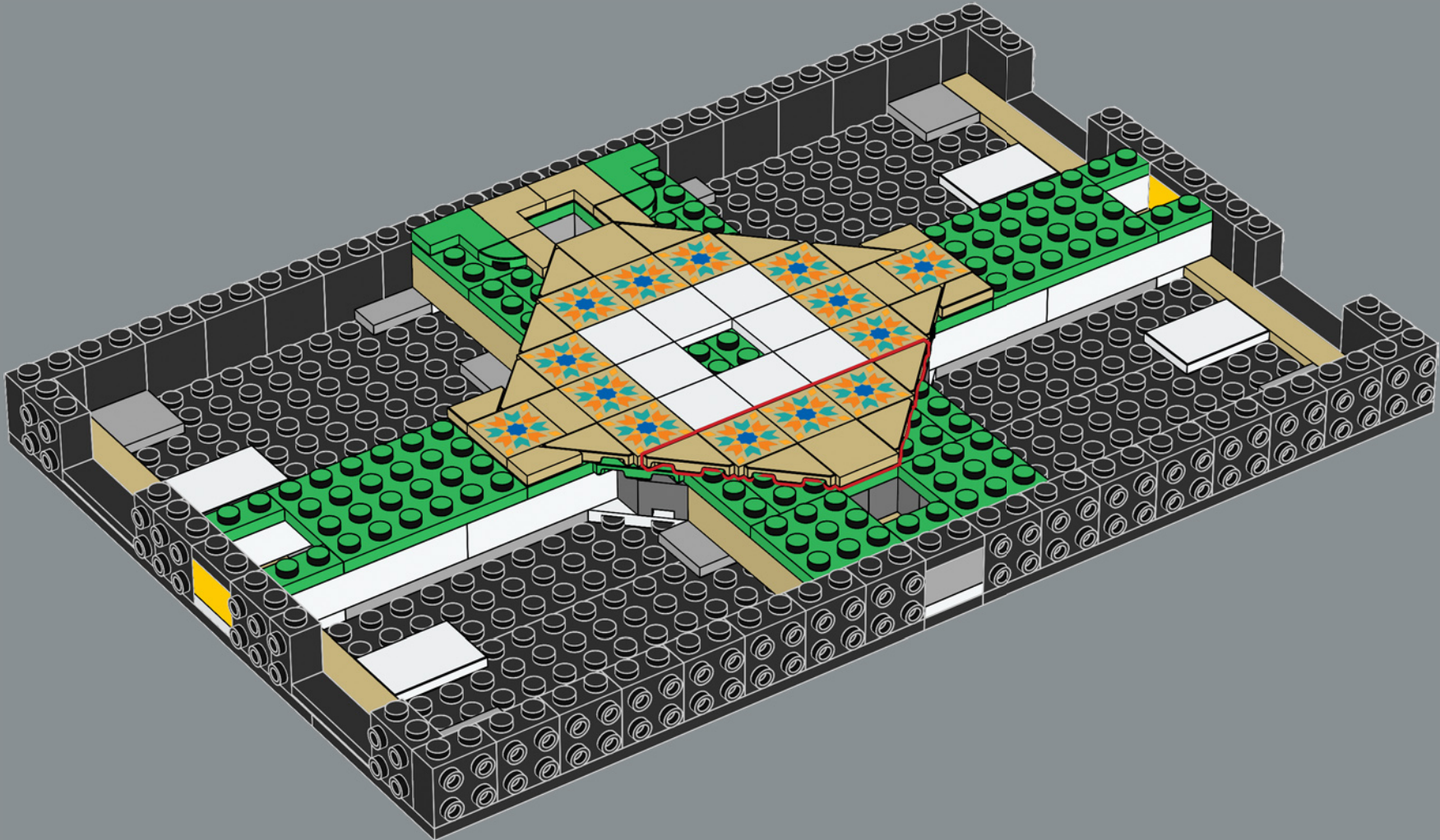

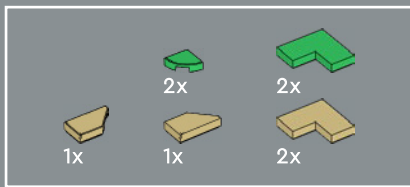

28

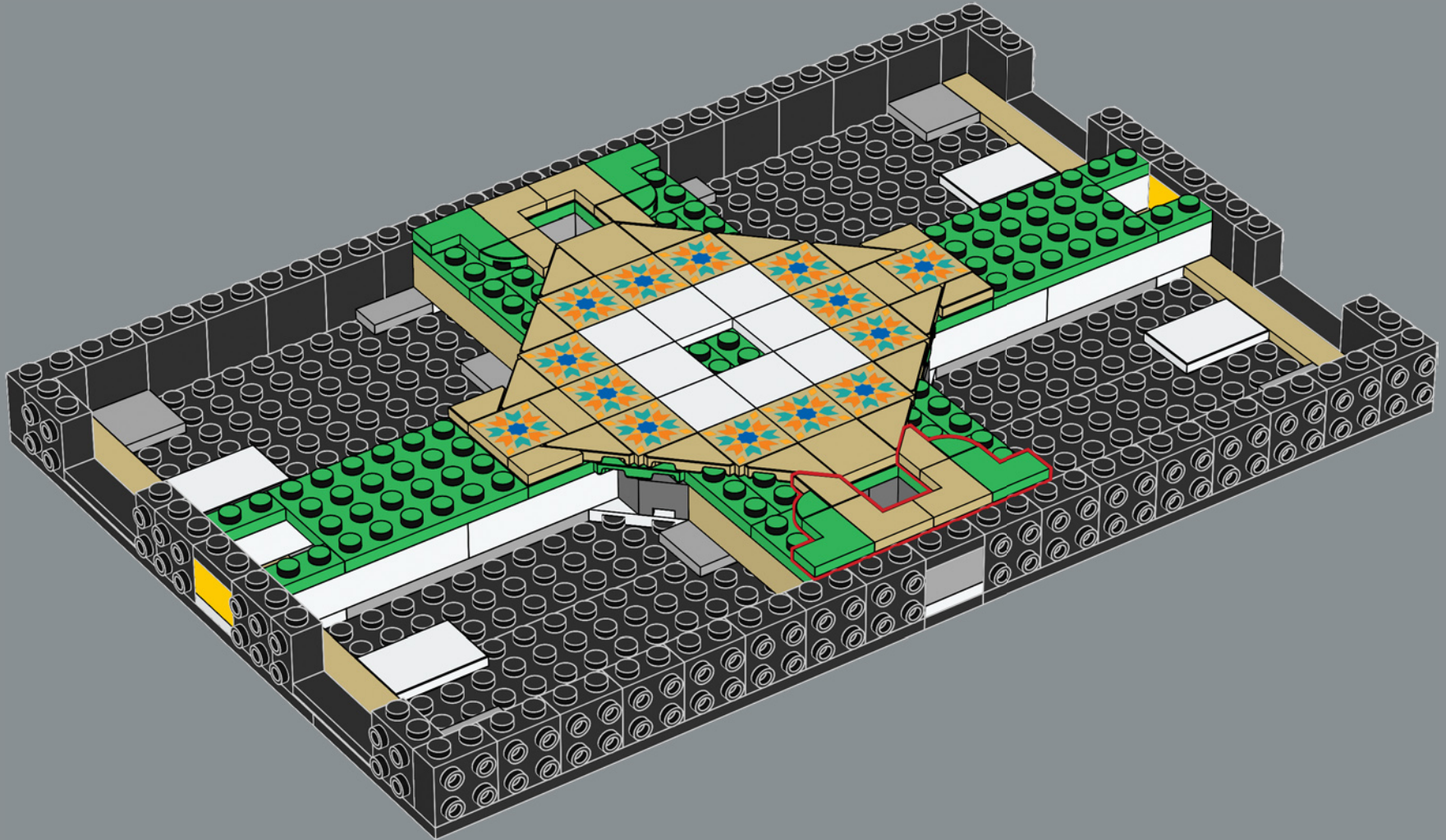

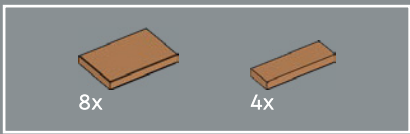

29

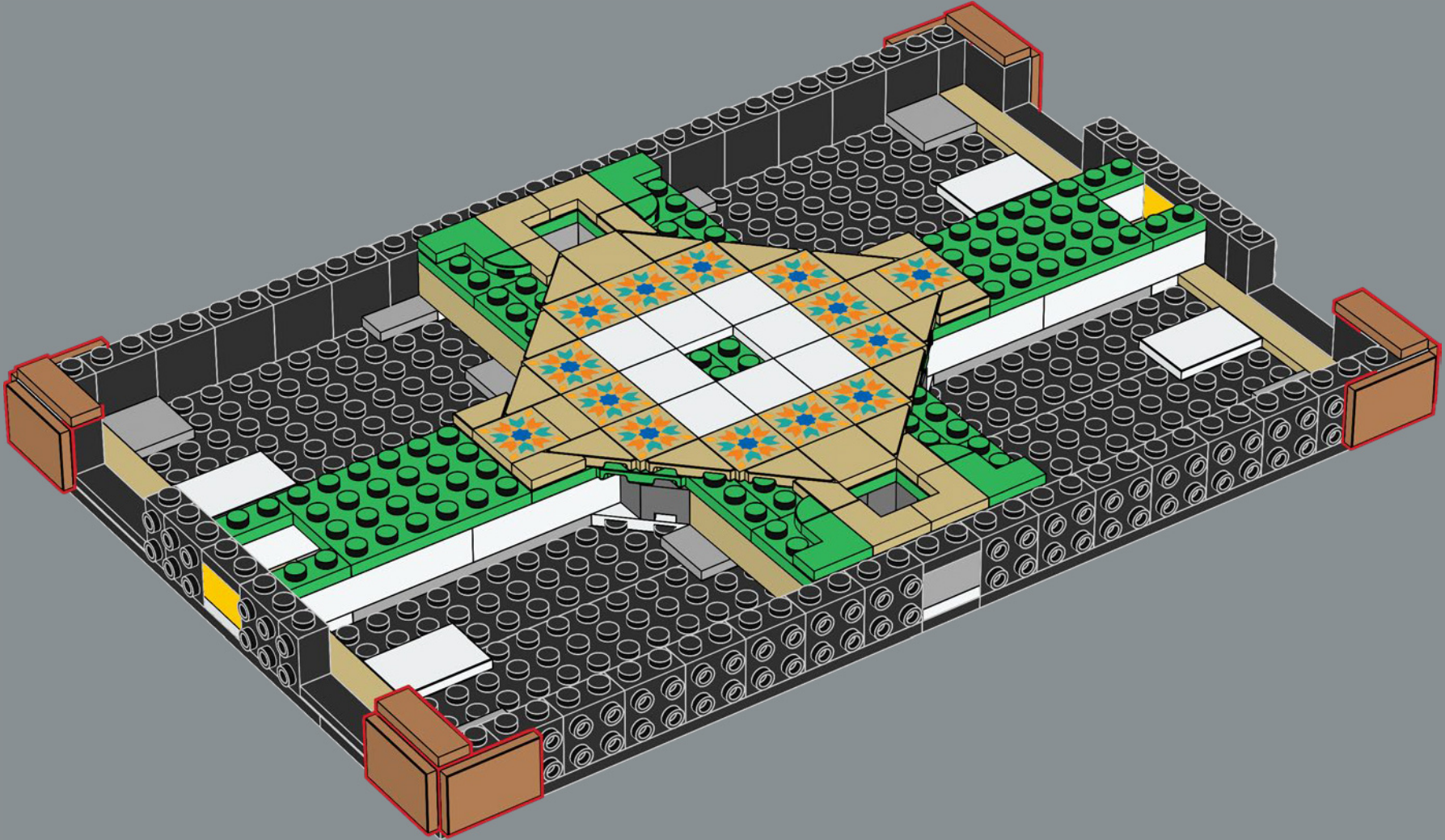



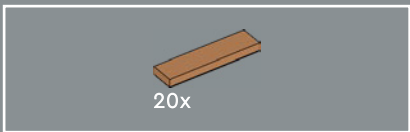

30

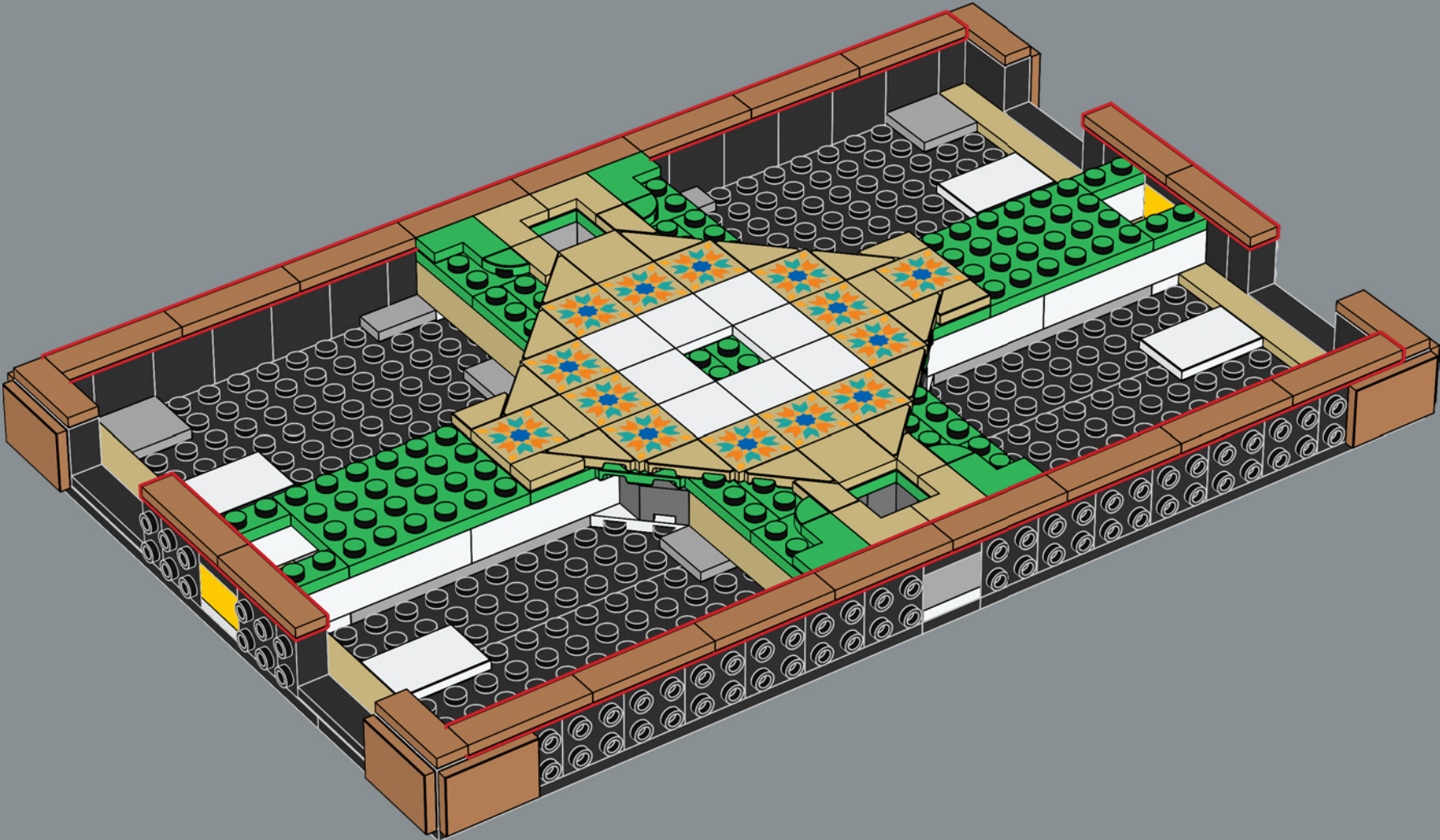

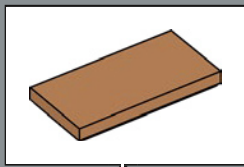

31

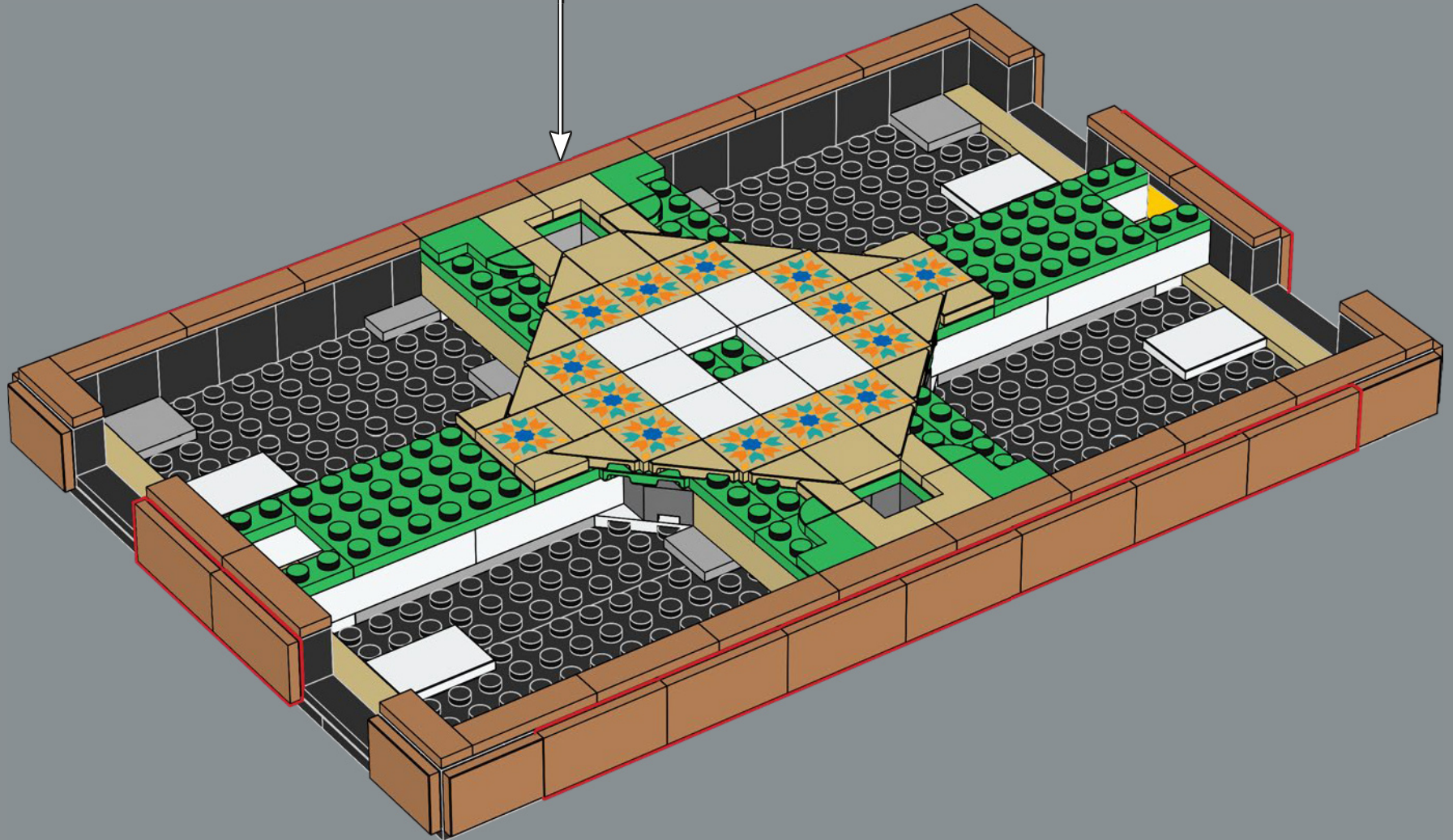

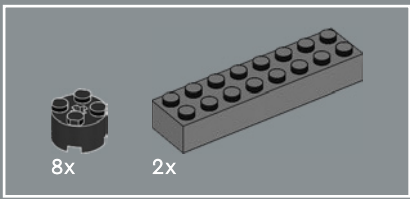

32

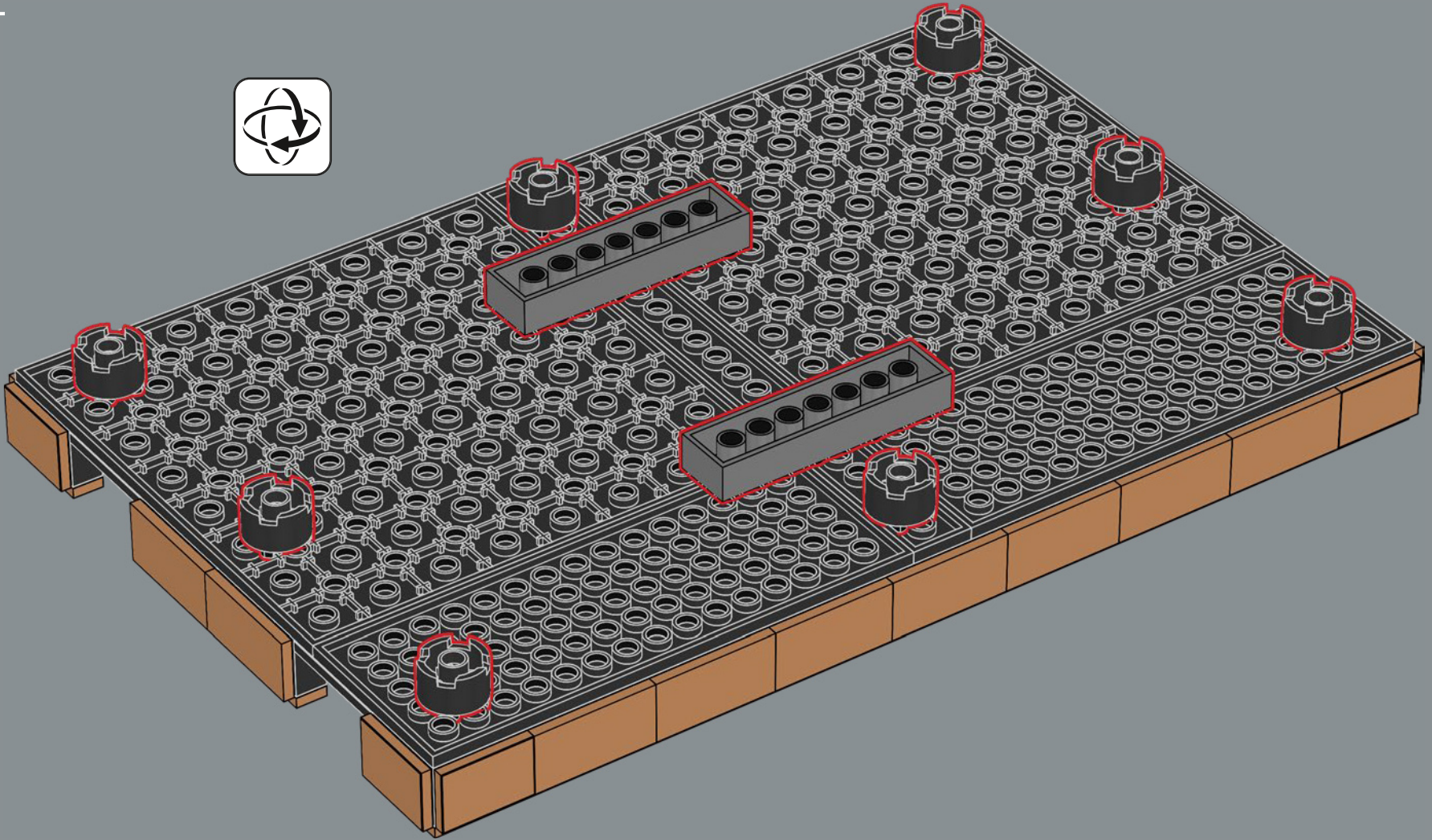

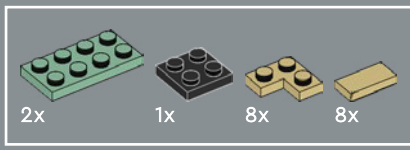

33

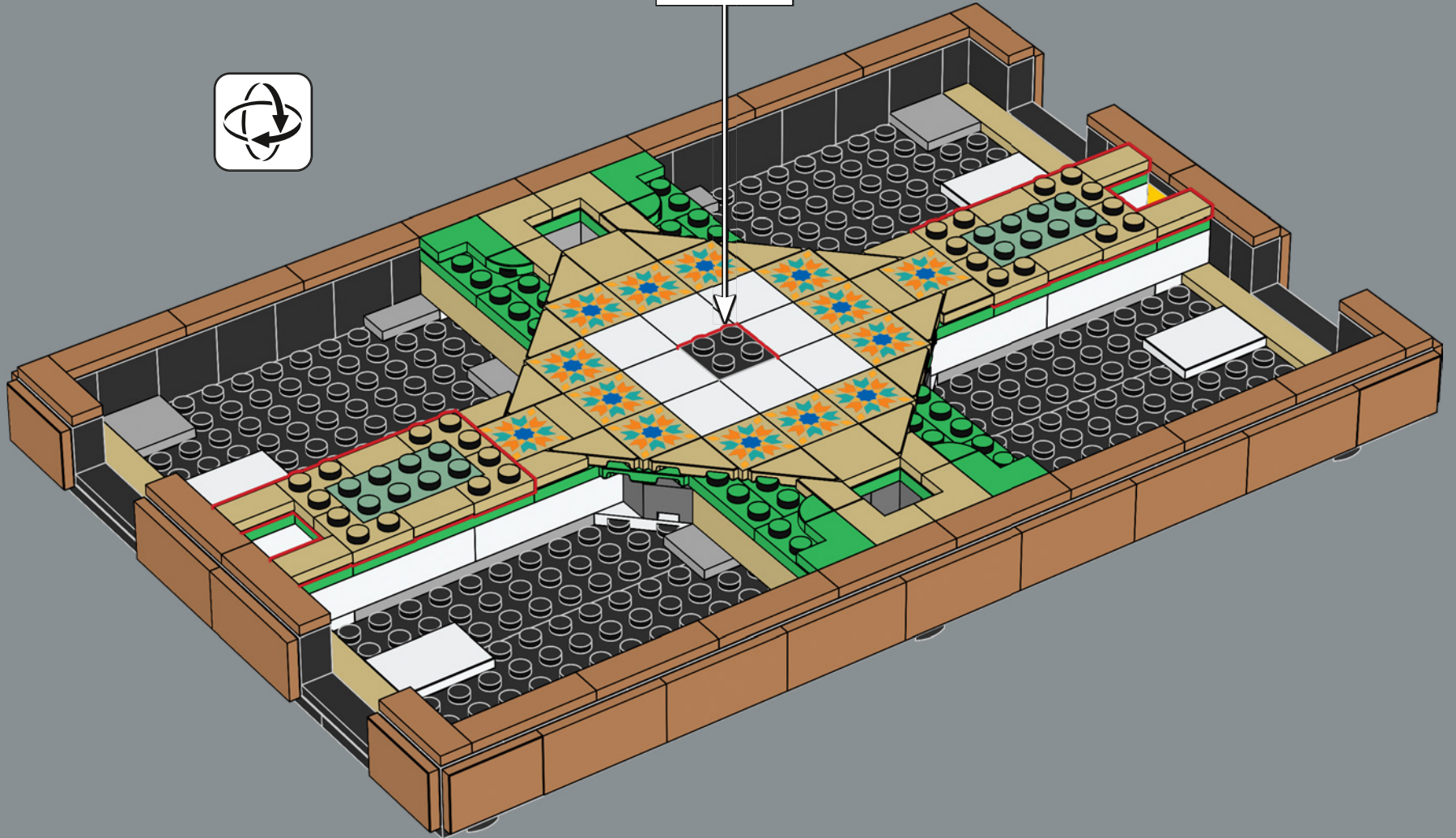
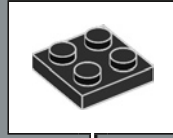



34

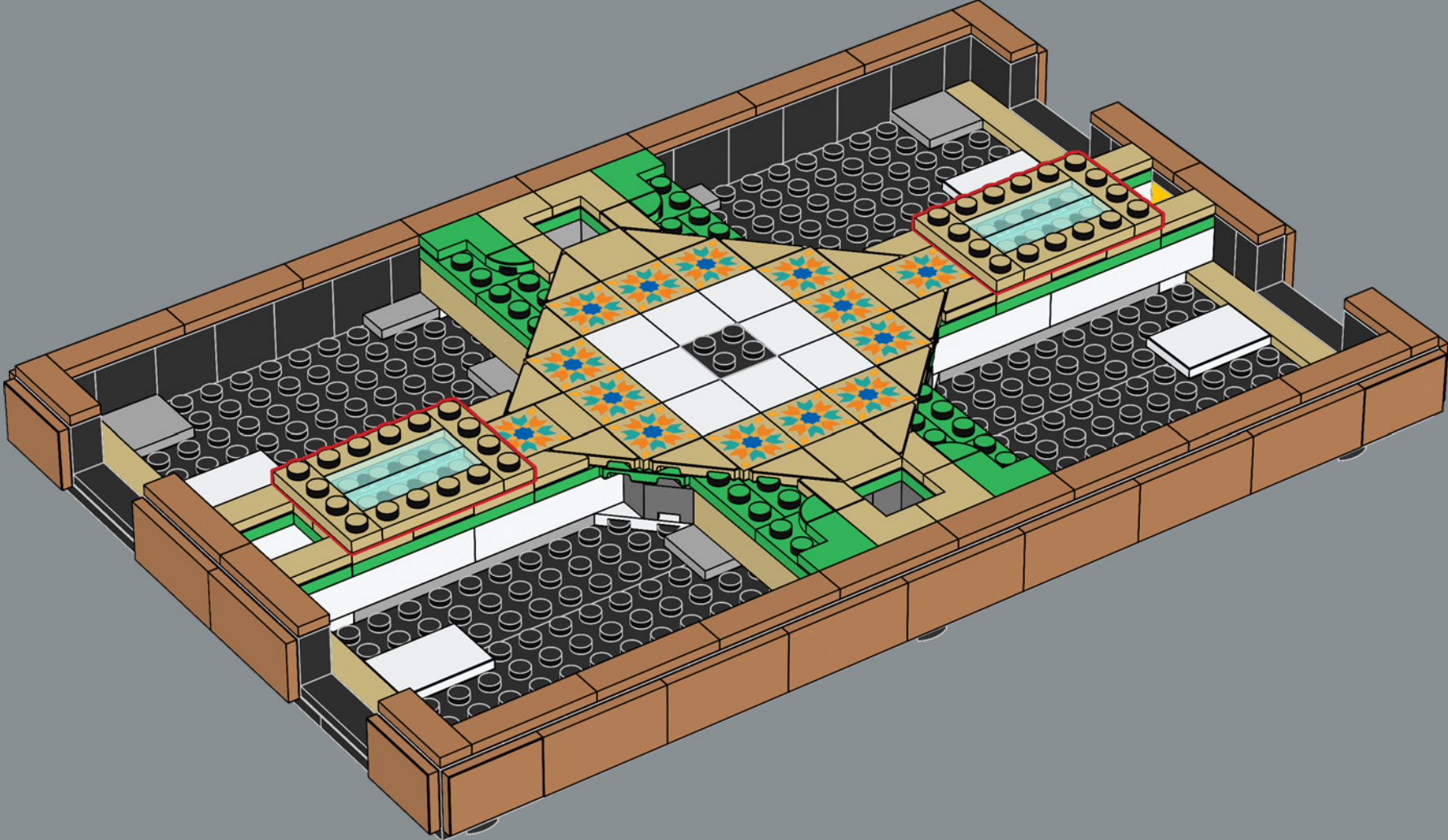

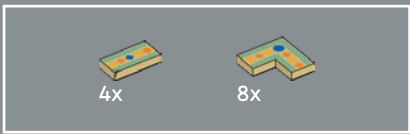

The decorated pieces created for this set were inspired by the *zellij* style of mosaic tilework. They are frequently found in the architecture of ancient historical sites and monuments in countries such as Morocco, Algeria, Tunisia and the Andalusian region of southern Spain.

35

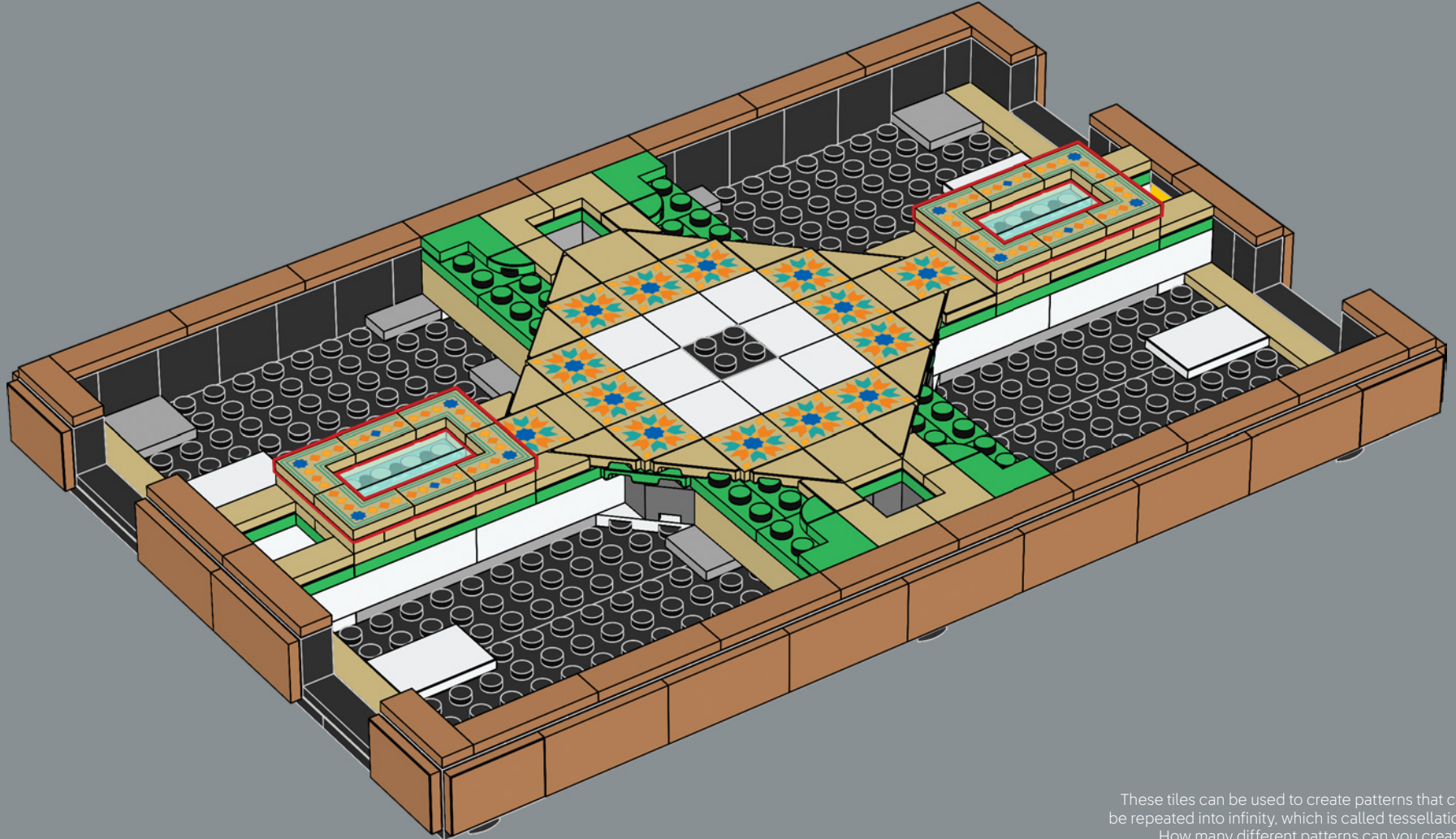

These tiles can be used to create patterns that can be repeated into infinity, which is called tessellation. How many different patterns can you create?

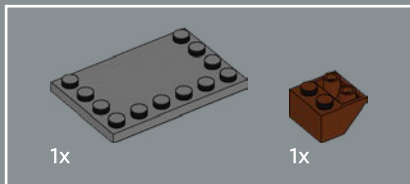
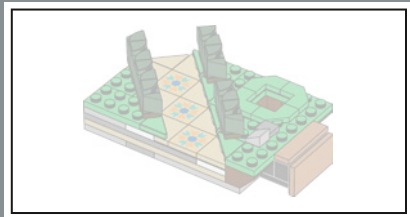

36

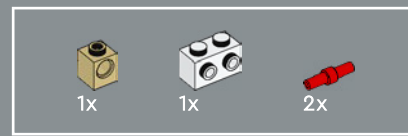
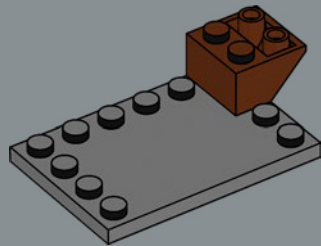

37

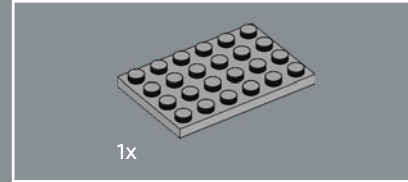
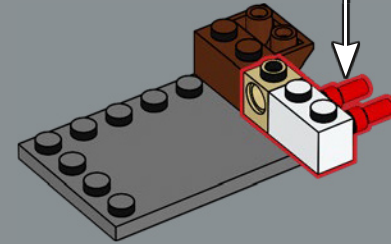
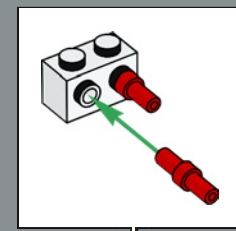

38

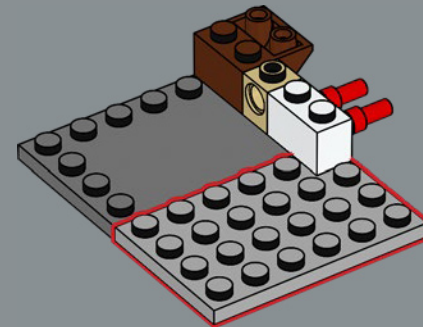



39

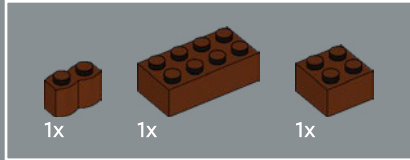
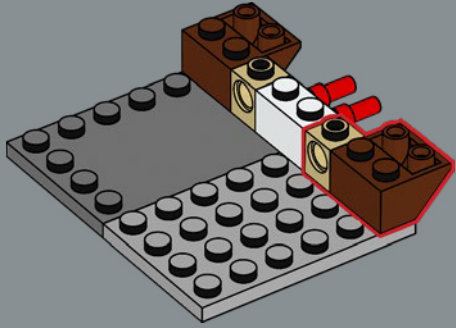

40

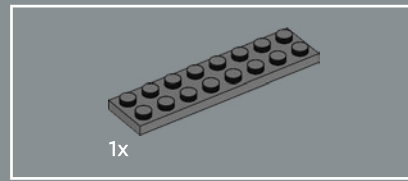
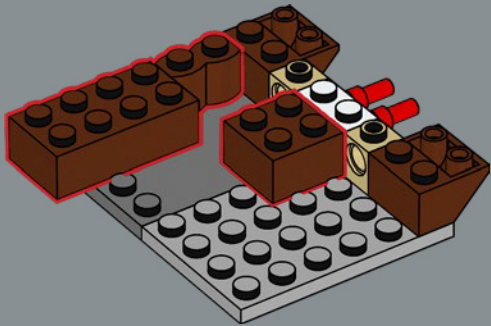

41

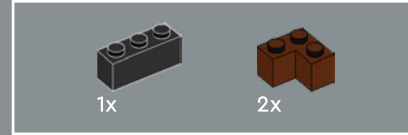
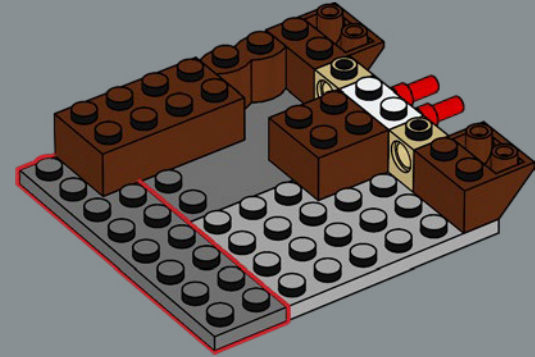

42

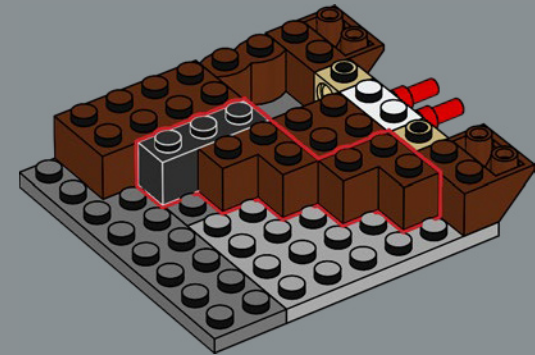

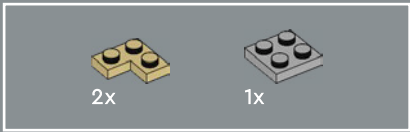

43

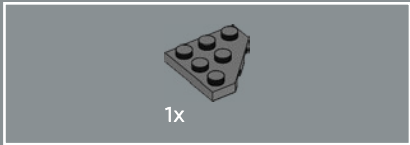
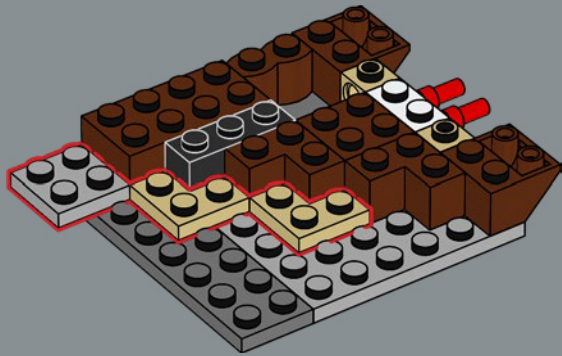

44

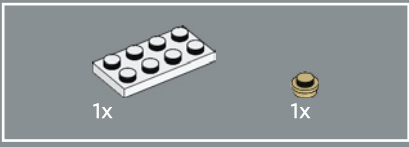
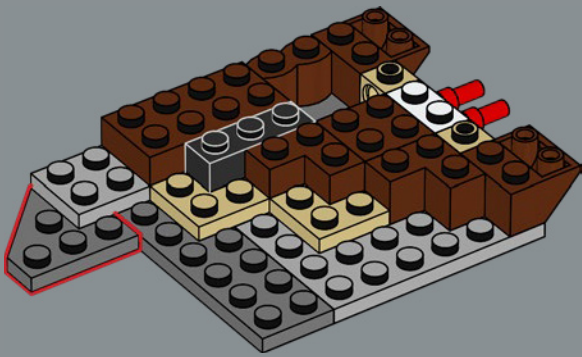

45

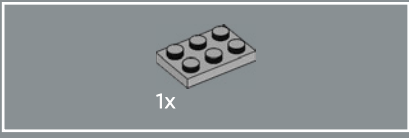
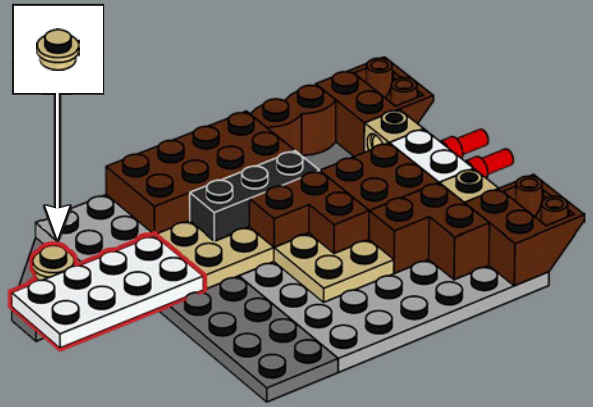

46

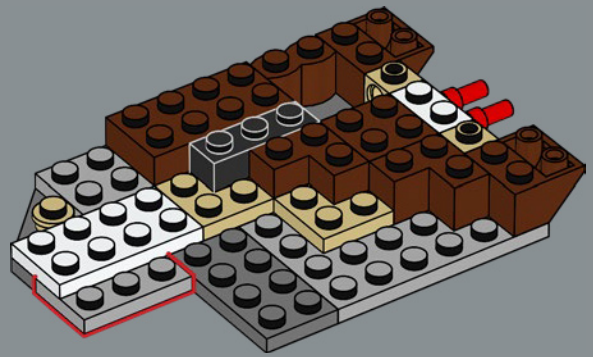

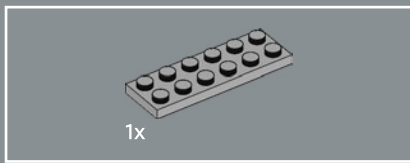

47

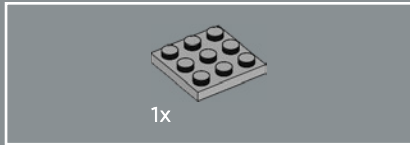
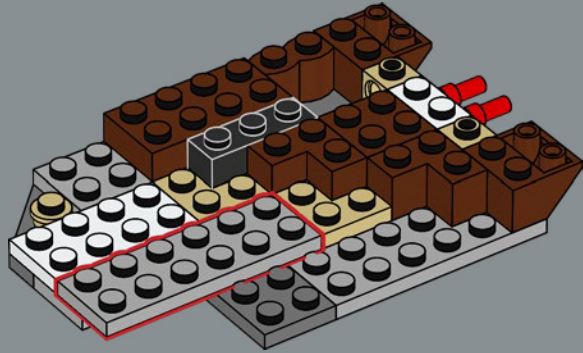

48

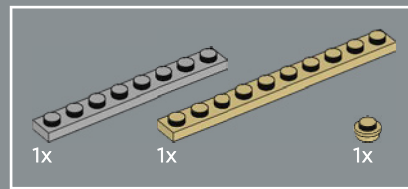
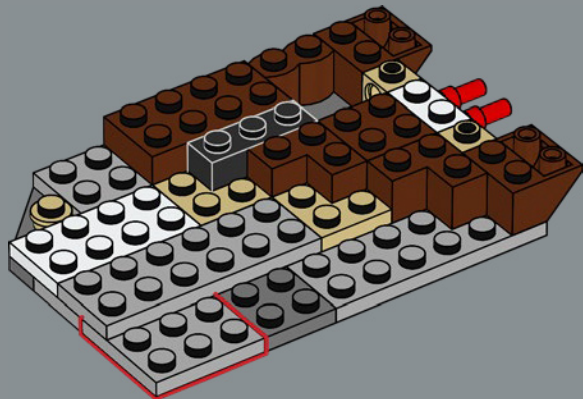

49



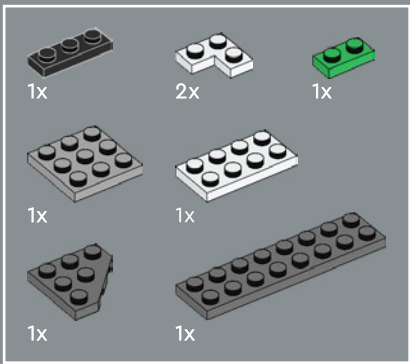

50

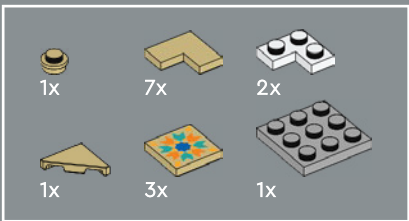

51

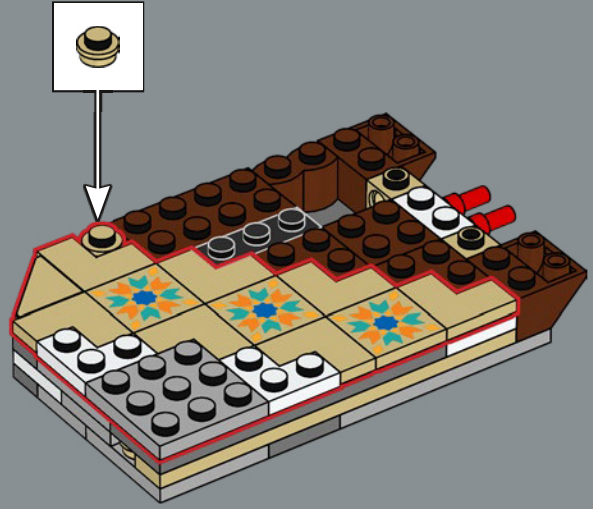

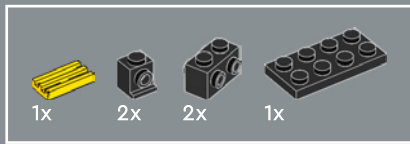

52

1

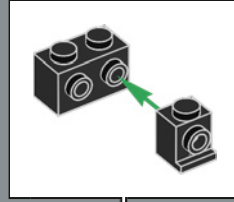
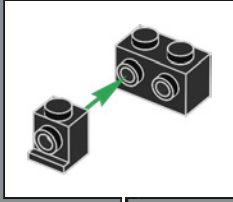
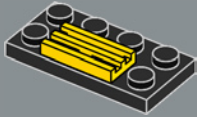

2

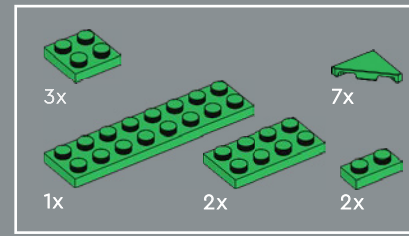
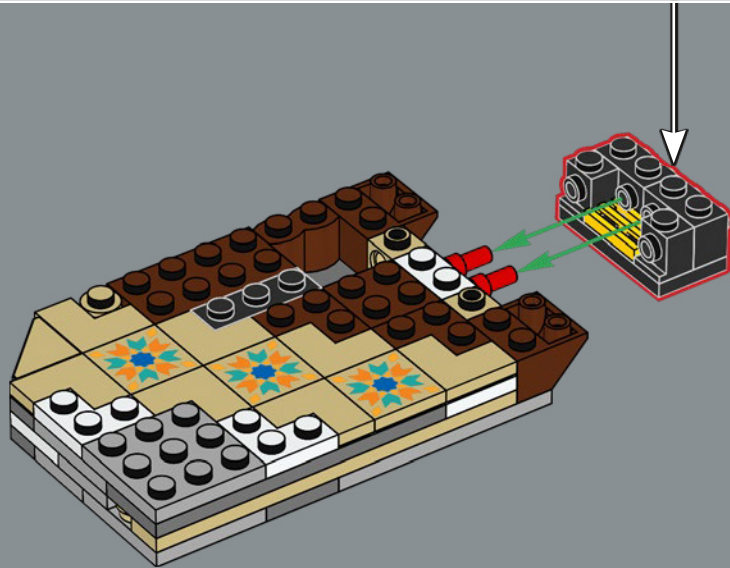
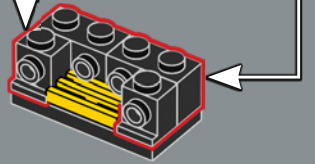

53

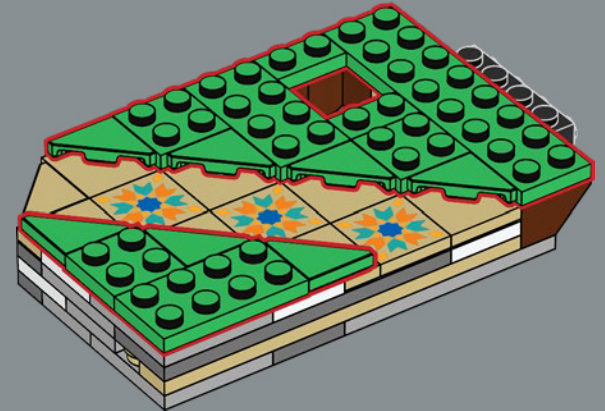



54

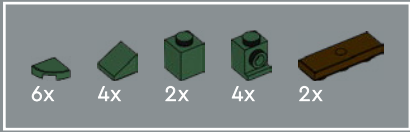
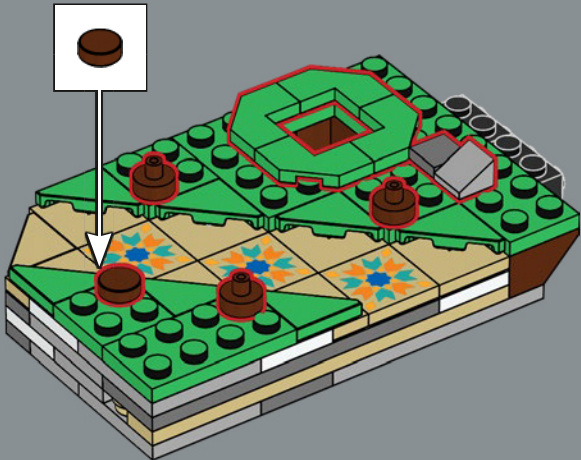

55

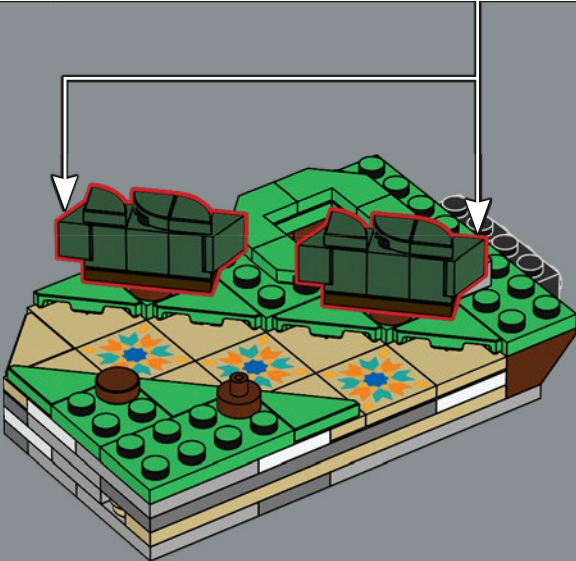
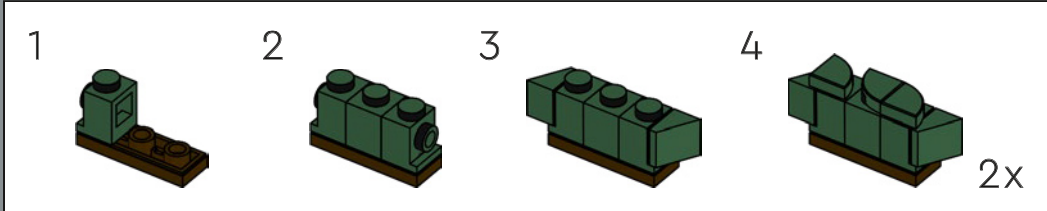

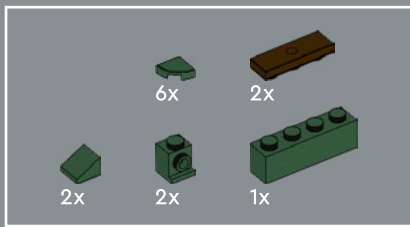

56

1



2

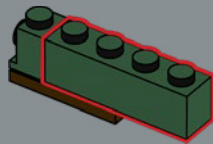

3

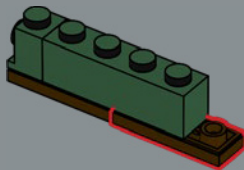

4

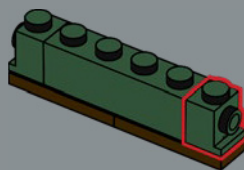

5

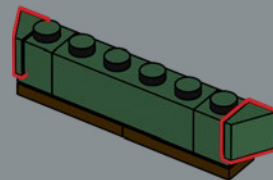

6

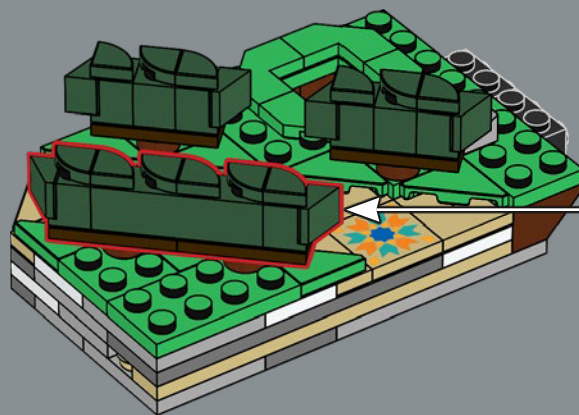
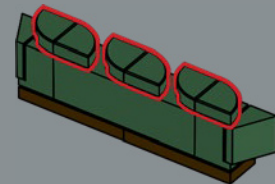

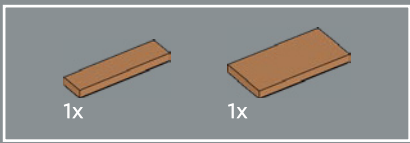

57

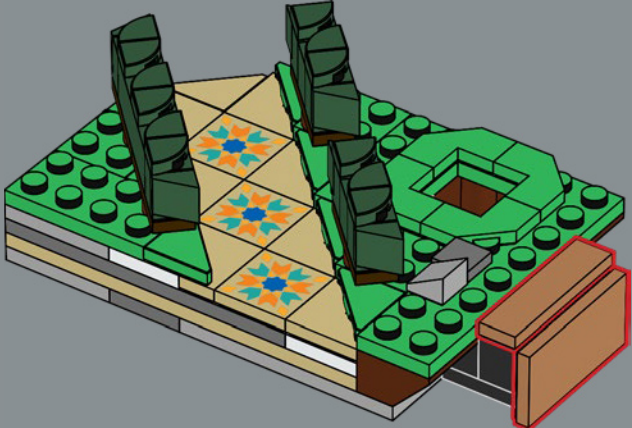

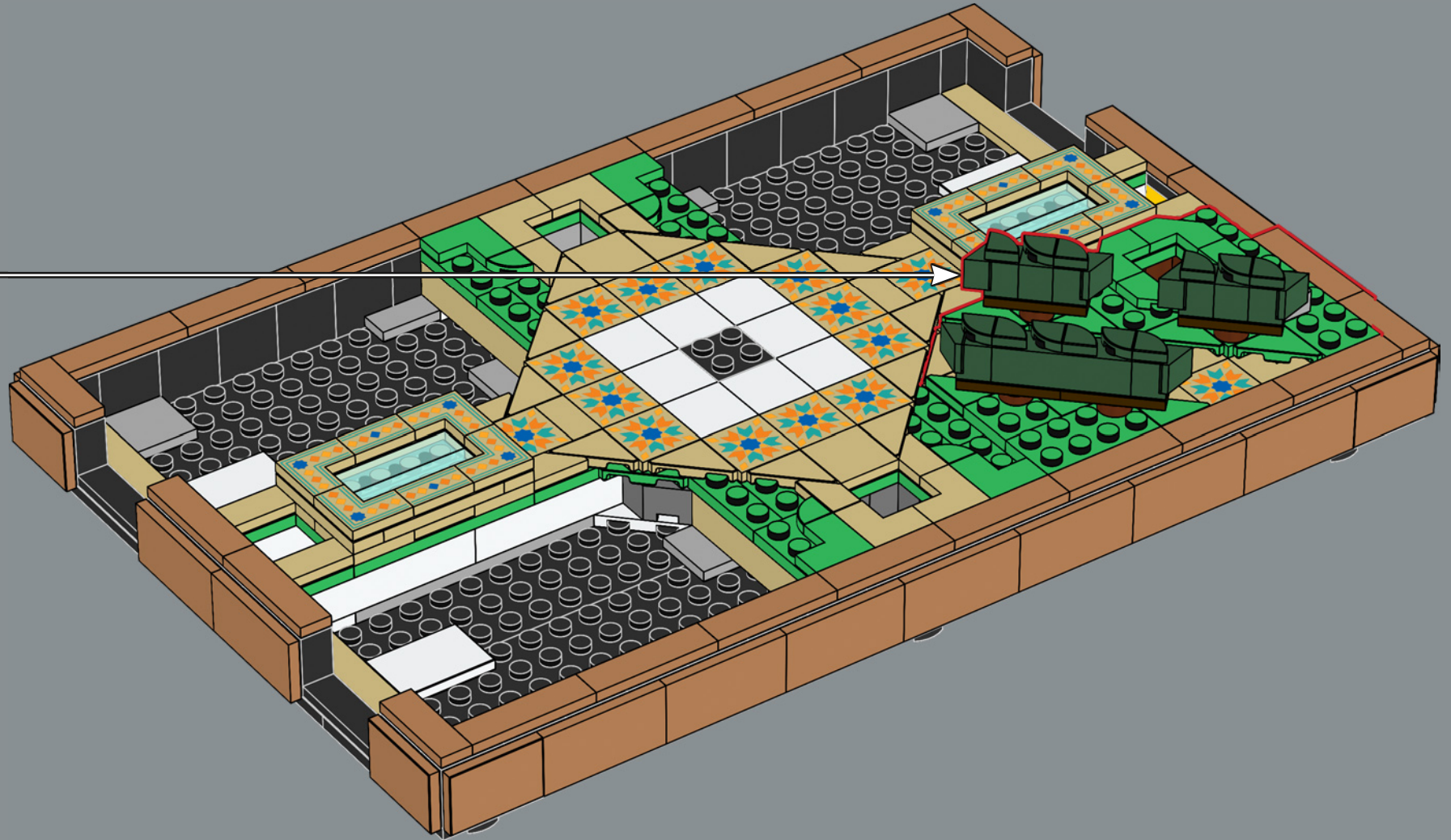

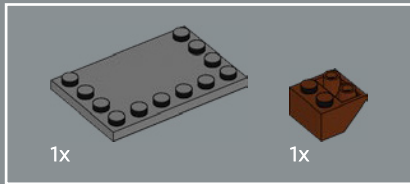
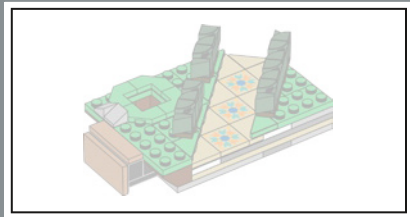

59

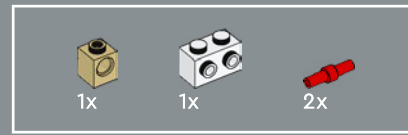
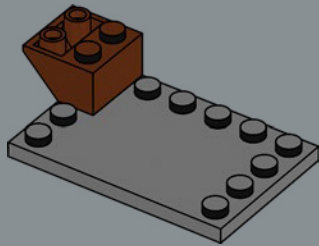

60

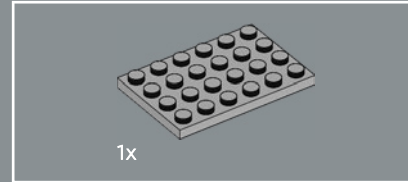
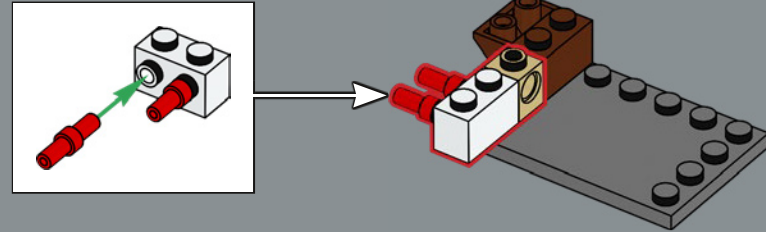

61

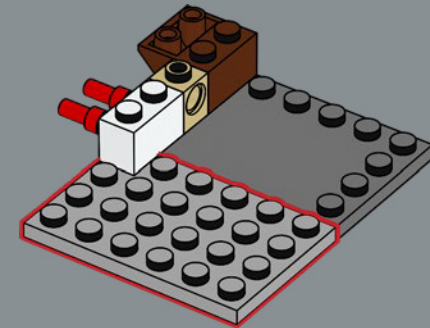

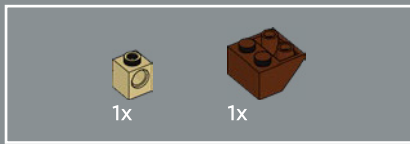

62

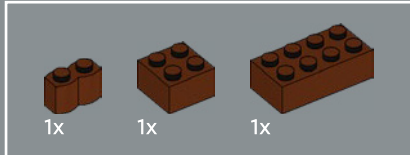
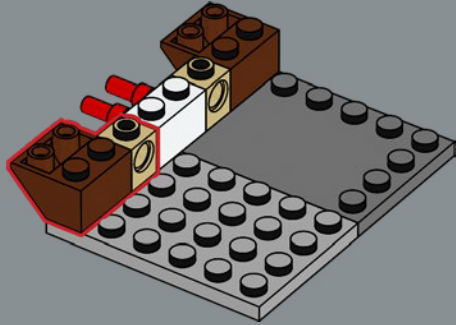

63

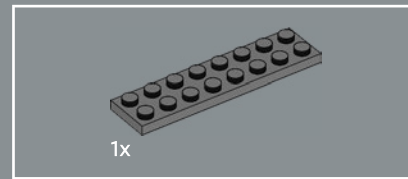
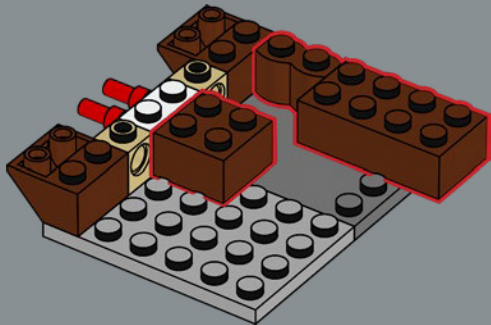

64

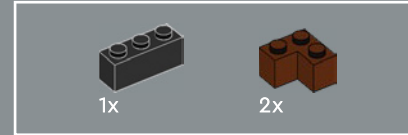
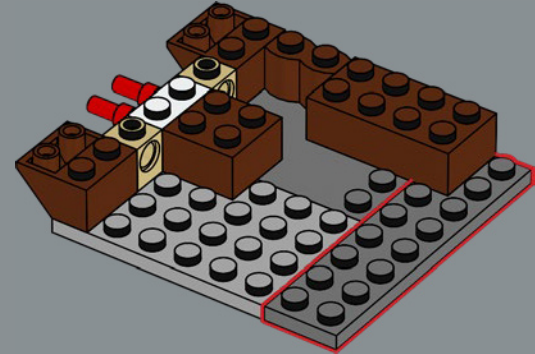

65

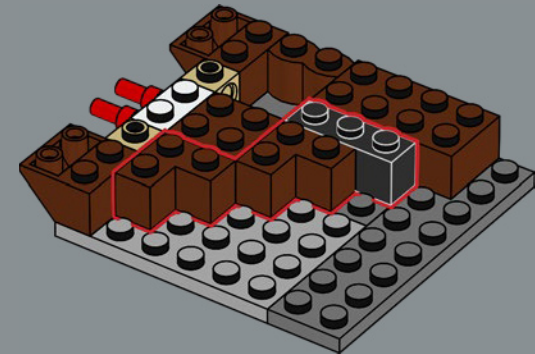

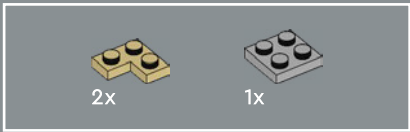

66

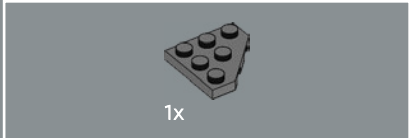
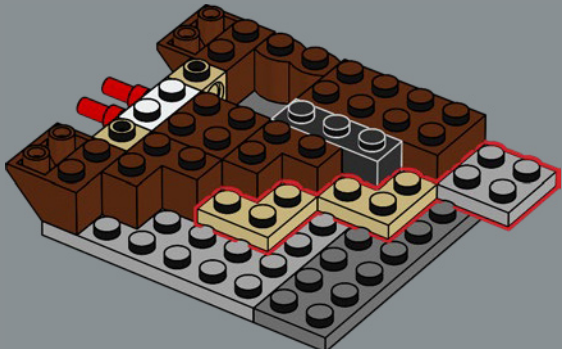

67

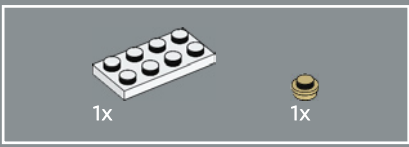
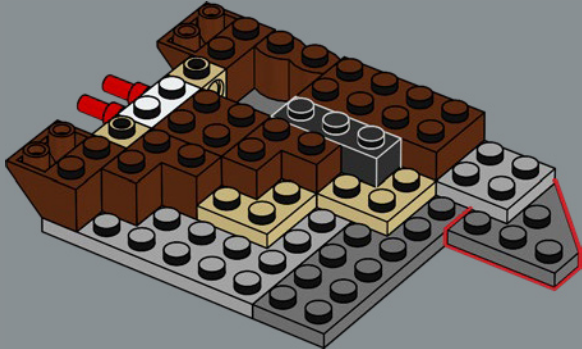

68

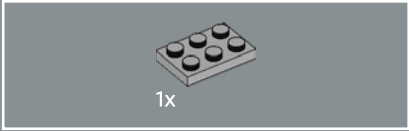
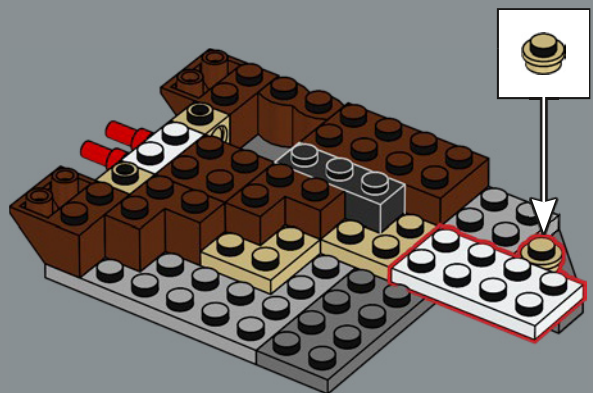

69

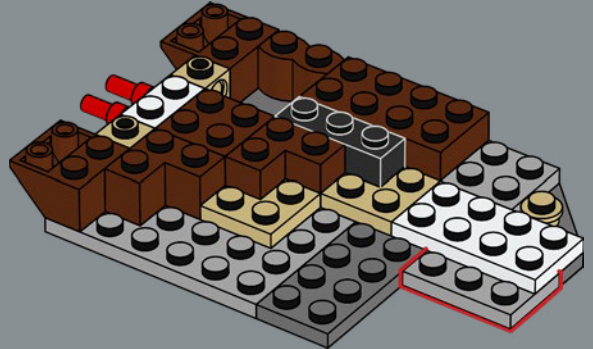

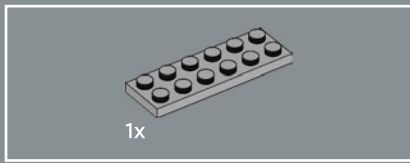

70

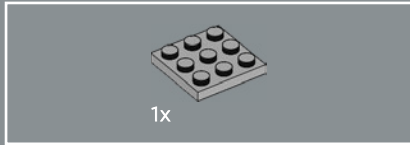
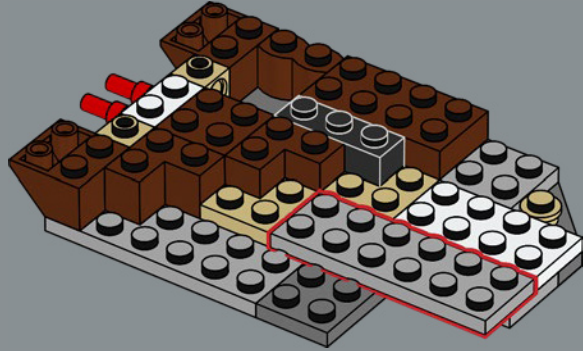

71

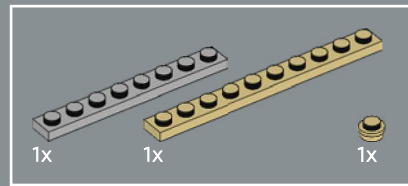
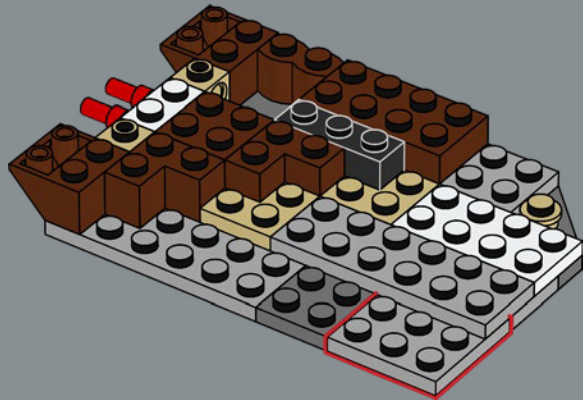

72

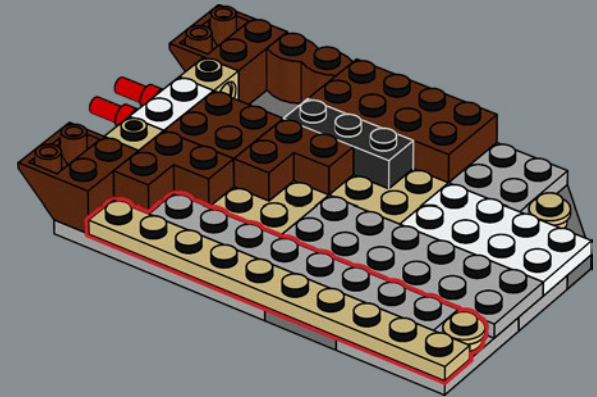

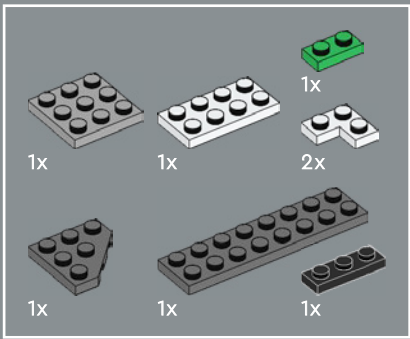

73

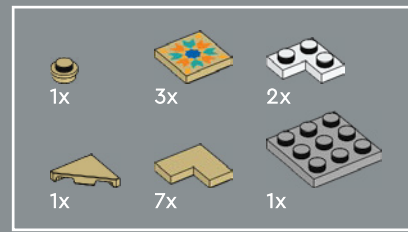
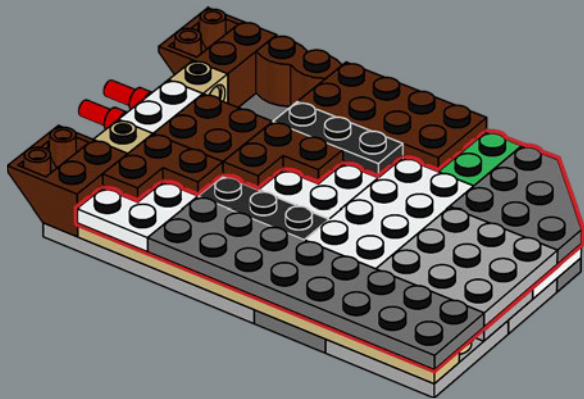

74

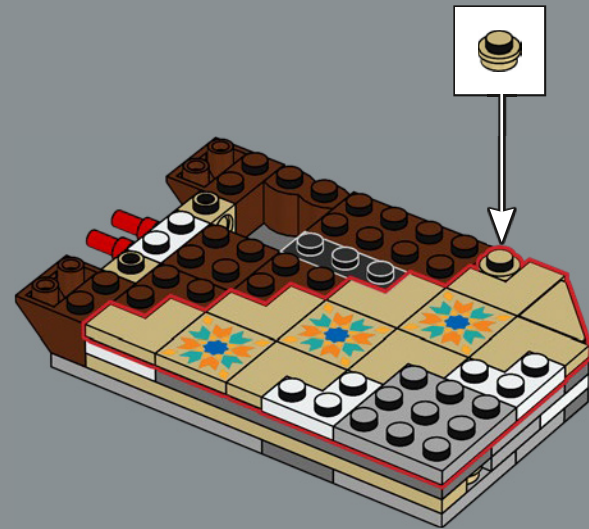

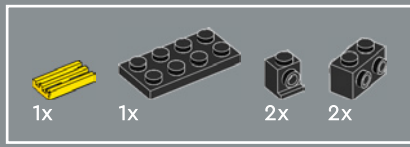

75

1

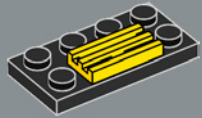

2

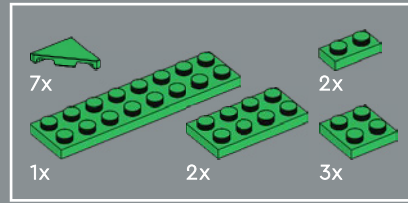
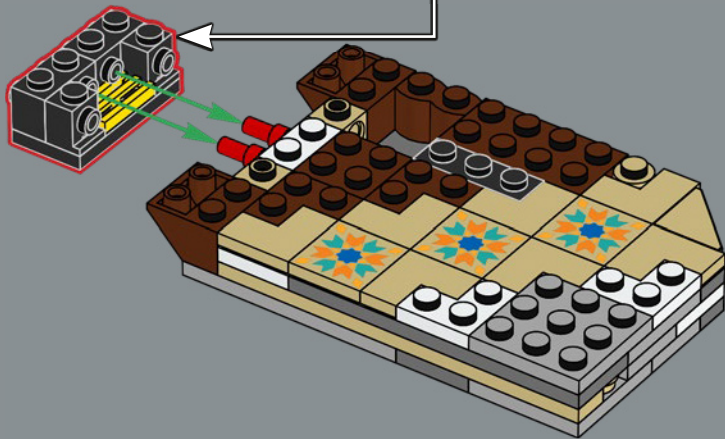
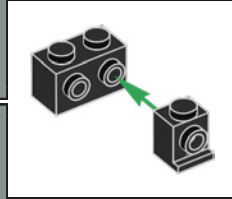
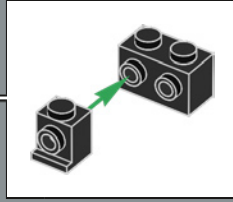
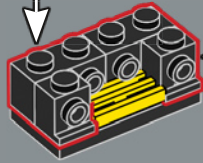

76

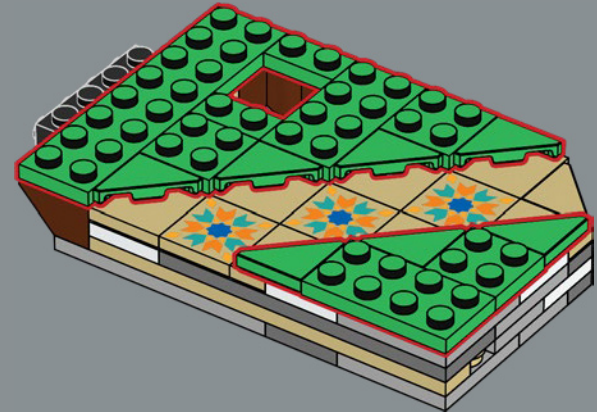

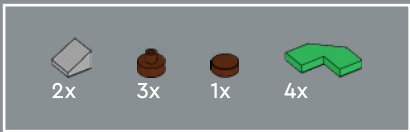

77

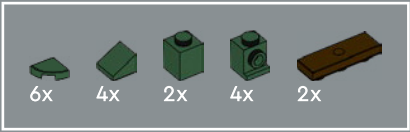
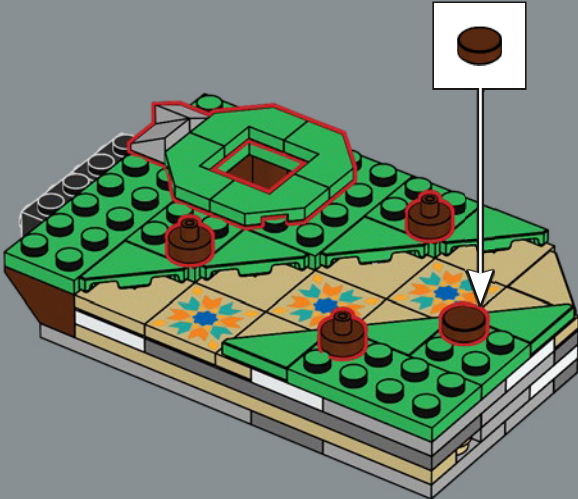

78

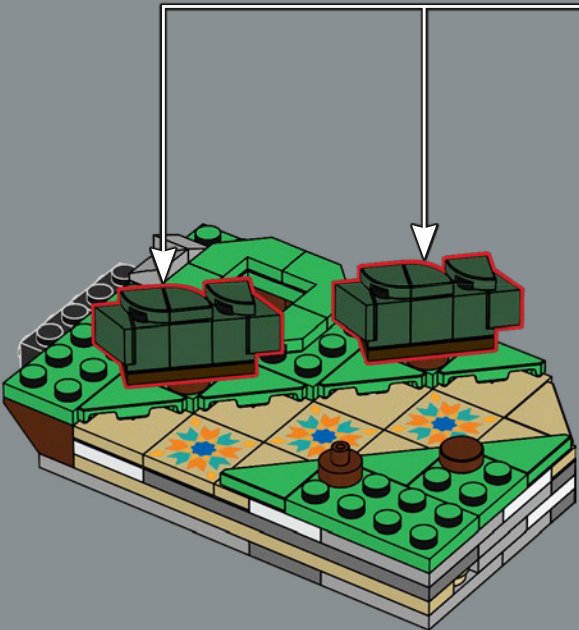
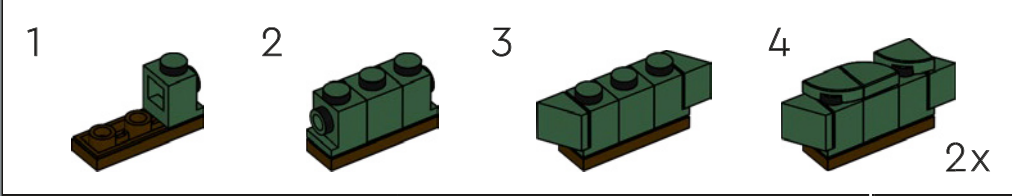

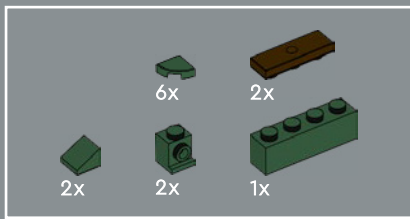

79

1



2

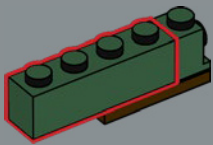

3

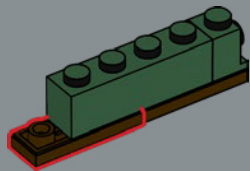

4

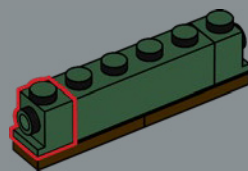

5

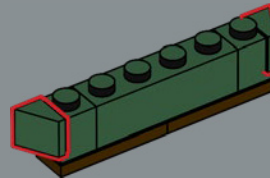

6

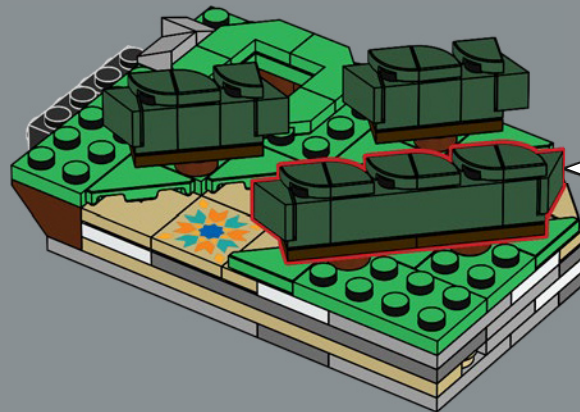
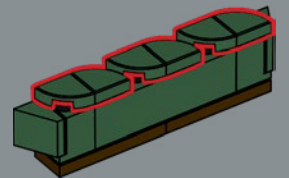

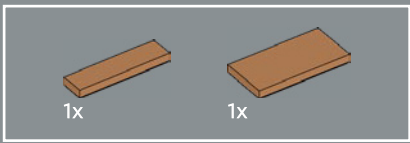

80

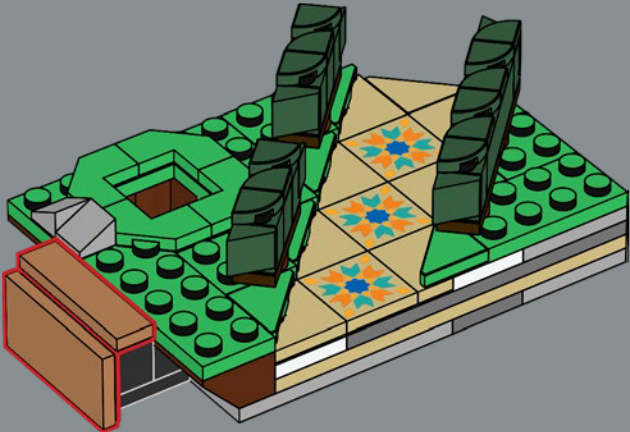

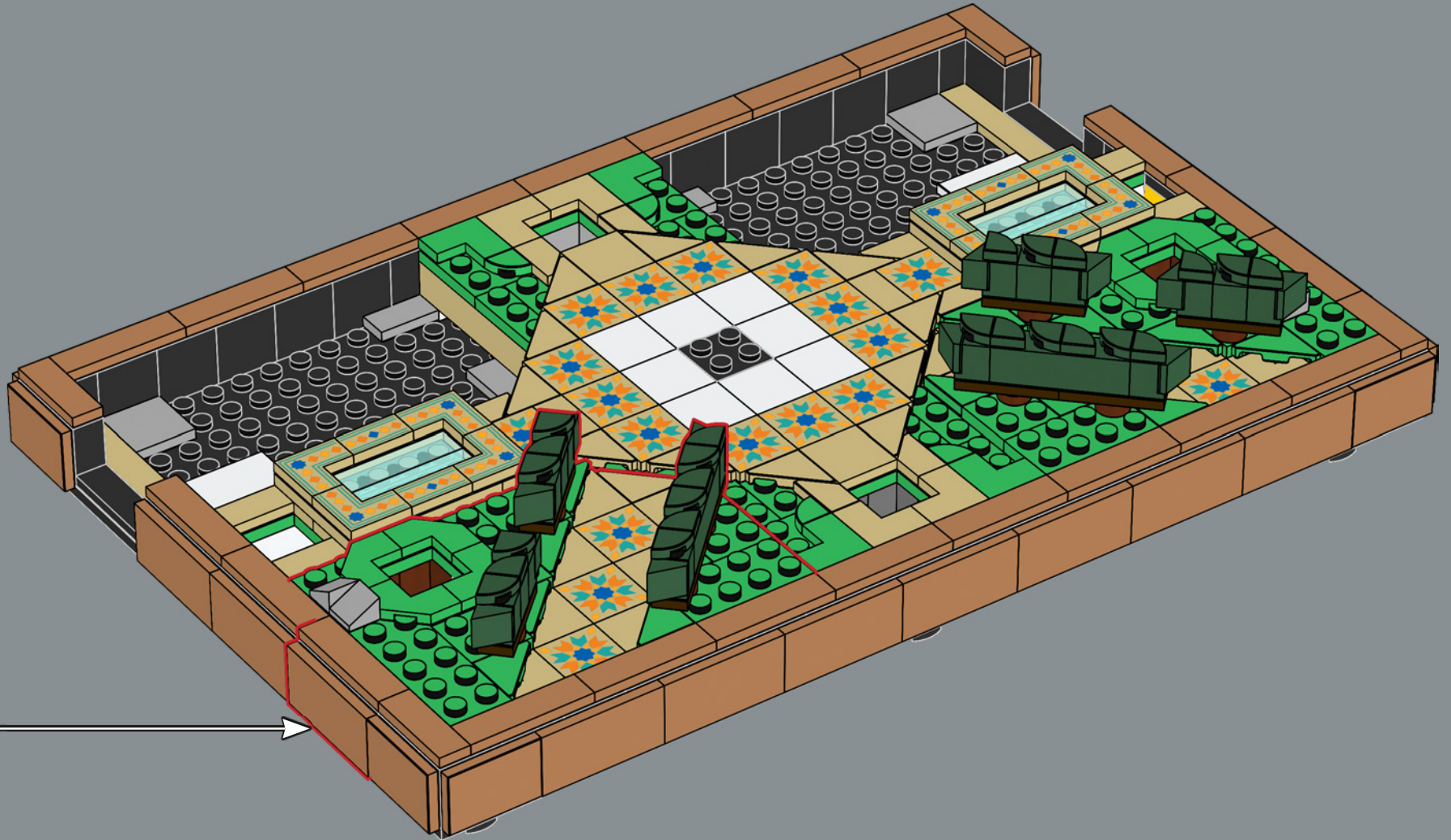

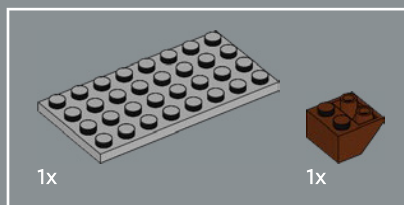
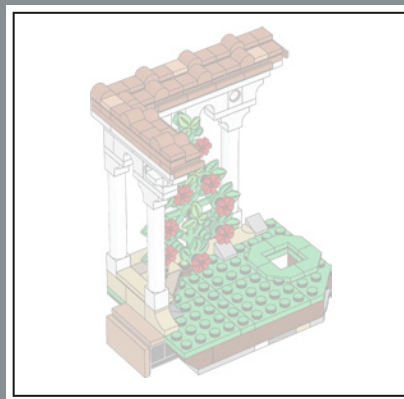

82

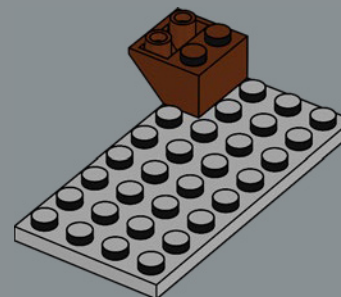

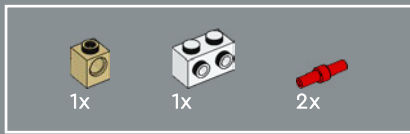

83

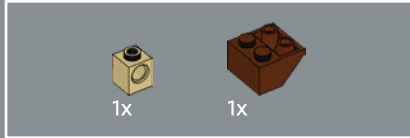
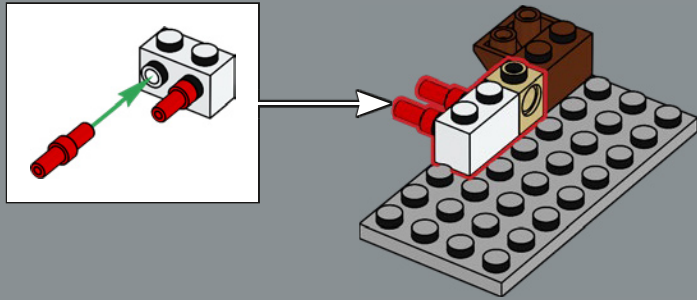

84

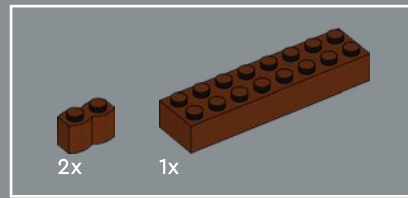
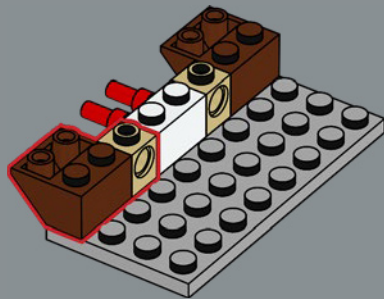

85

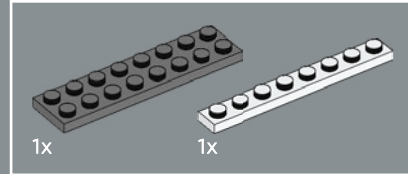
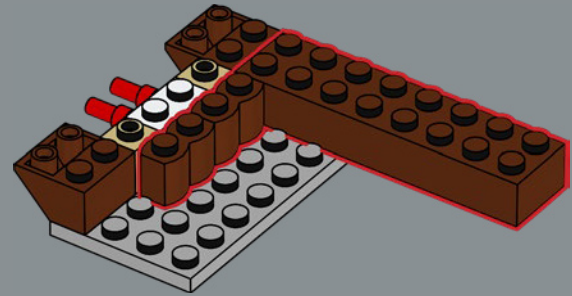

86

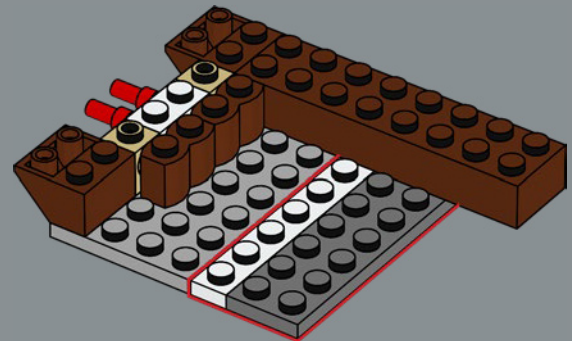

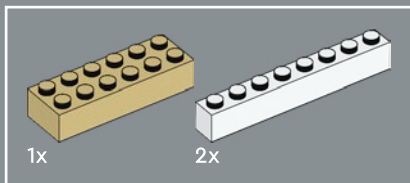

87

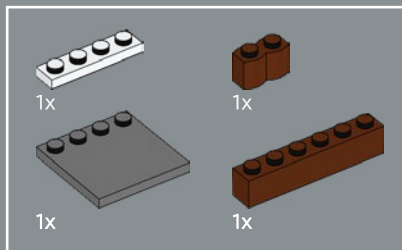
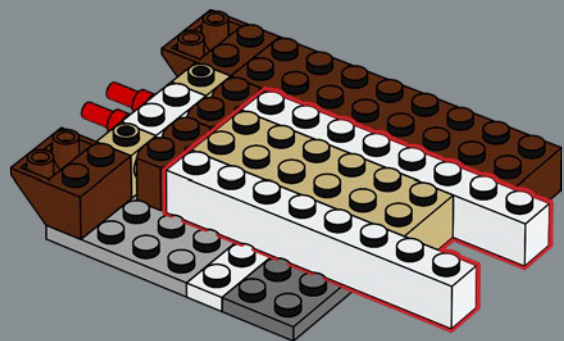

88

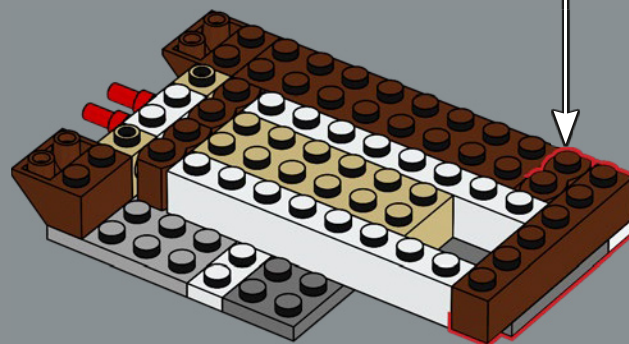
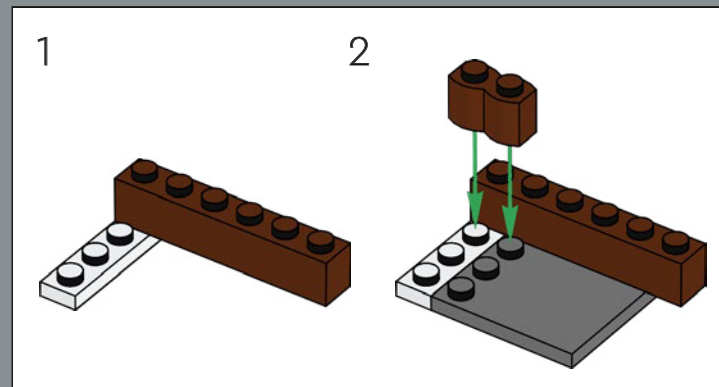

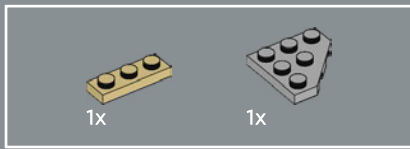

89

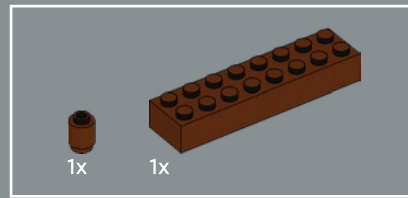
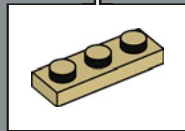
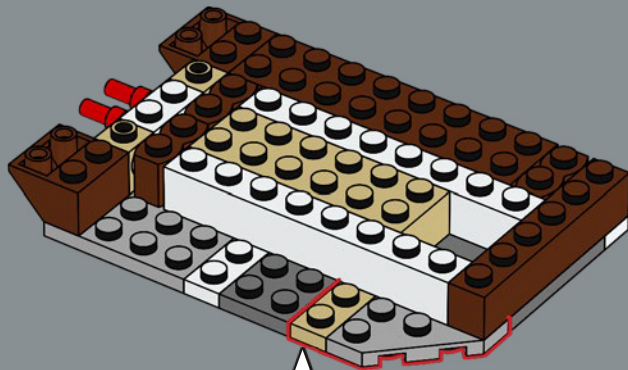

90

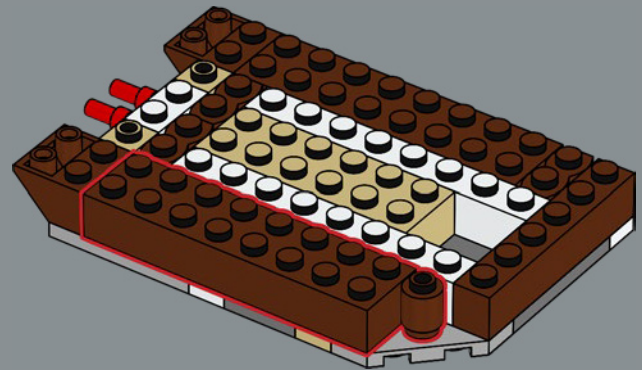

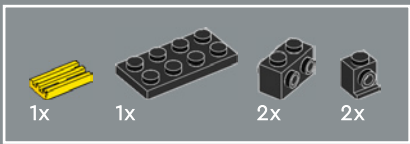

91

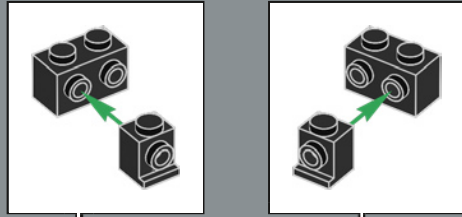

1

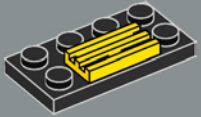

2

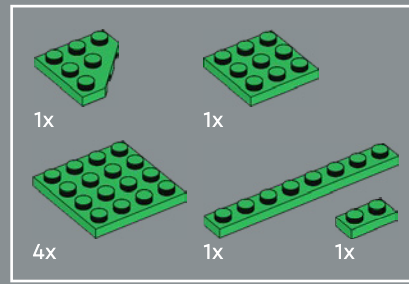
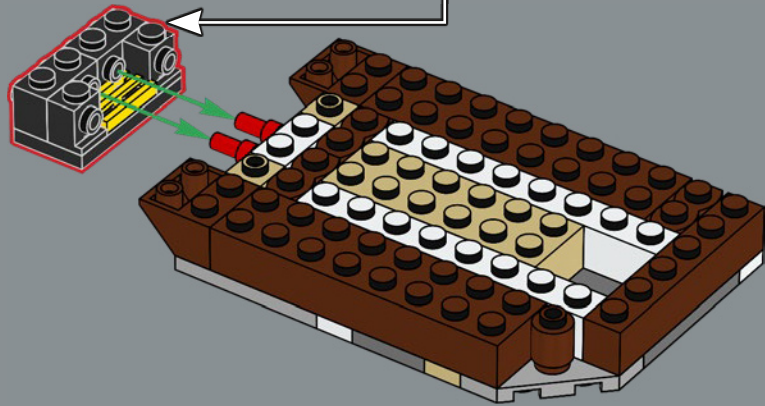
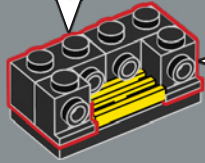

92



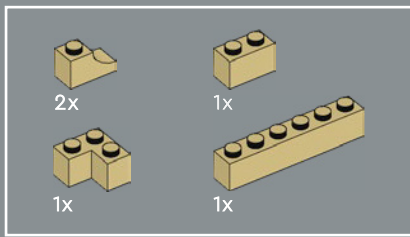

93

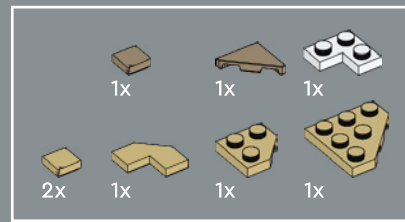
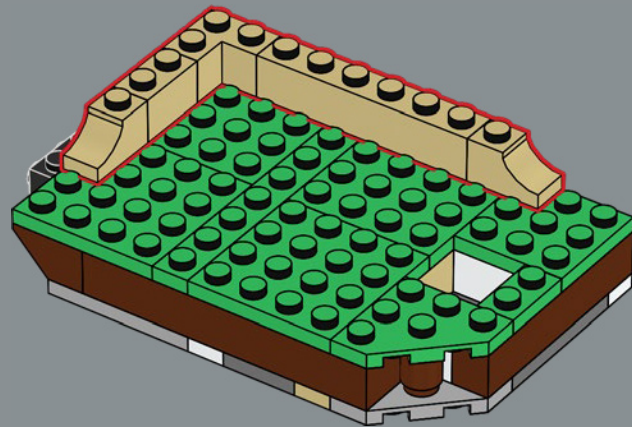

94

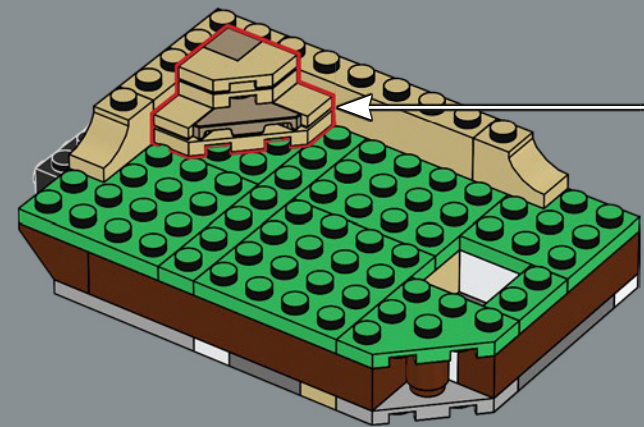
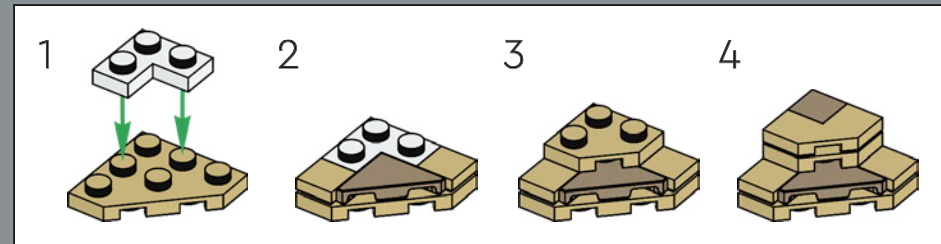



95

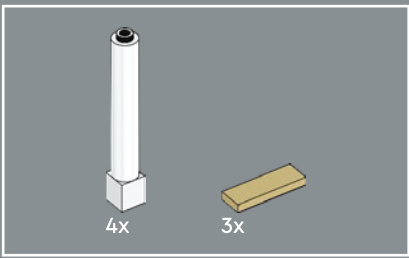
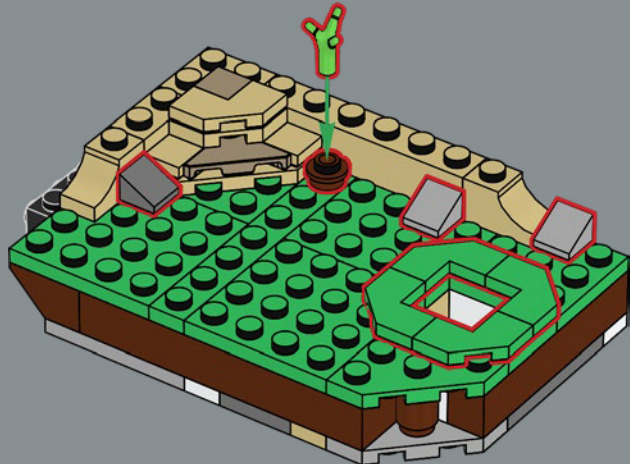

96

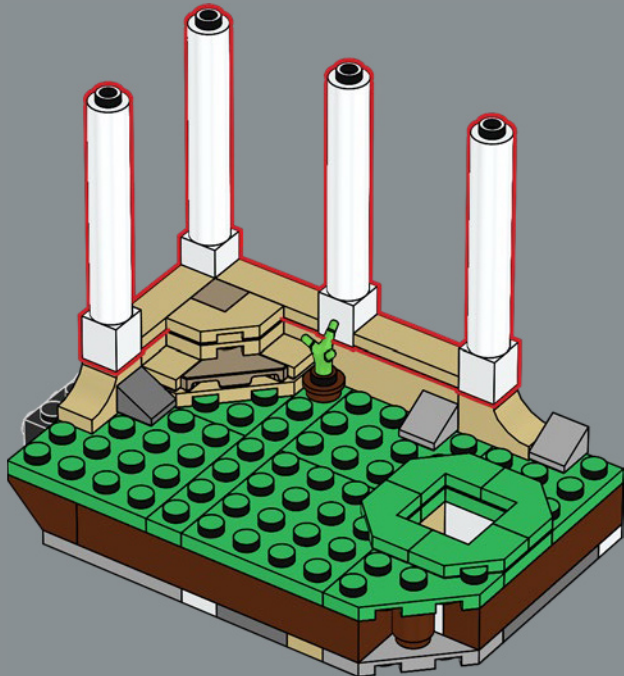

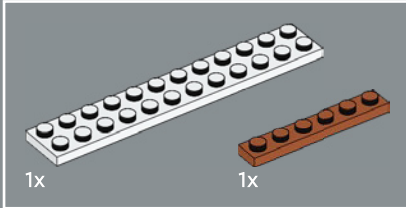
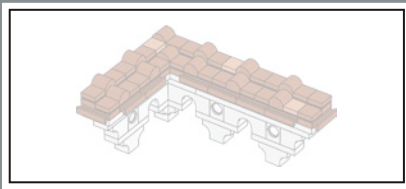

97

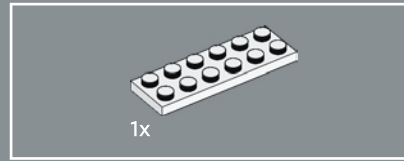
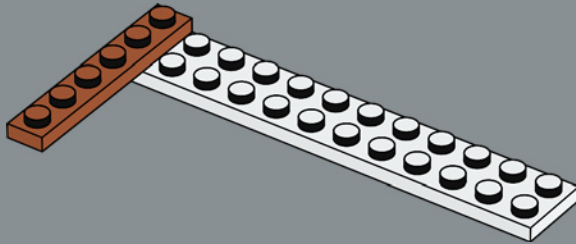

98

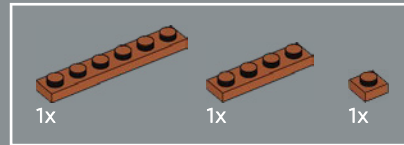
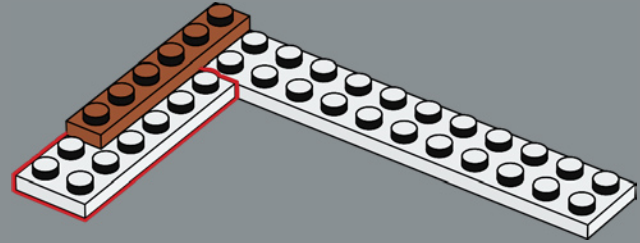

99

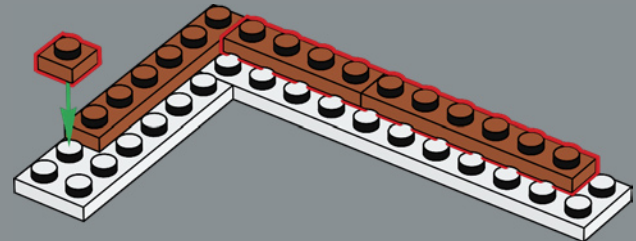



100

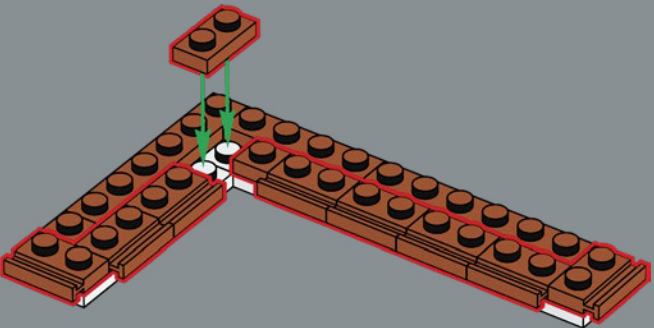

102

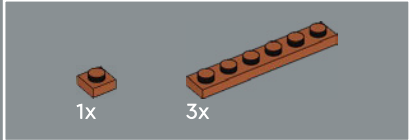
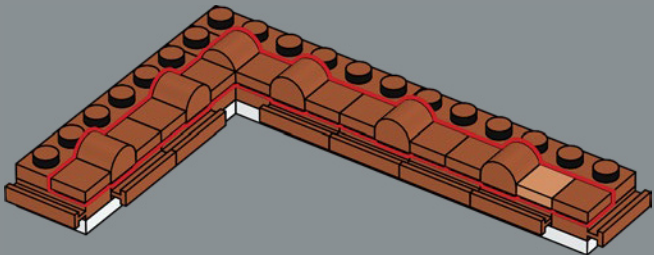

101

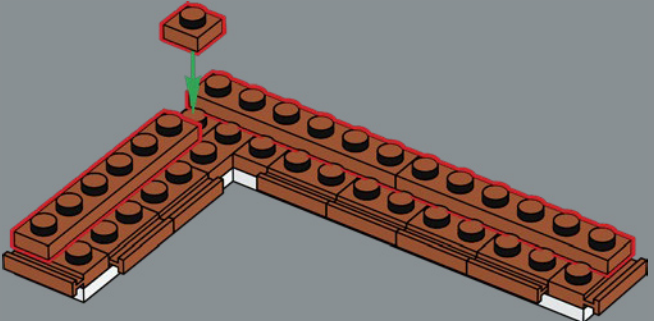

103

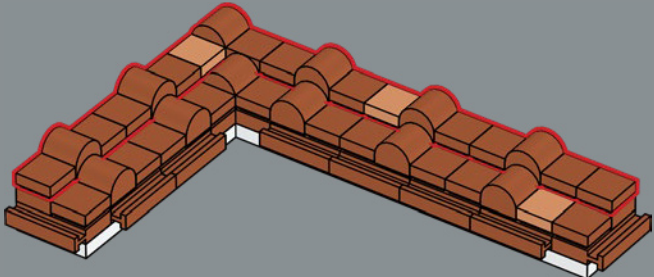

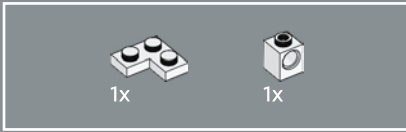
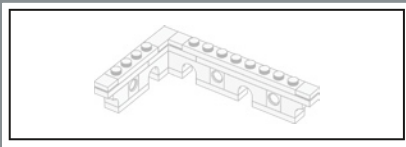

104

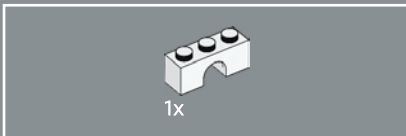
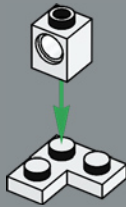

105

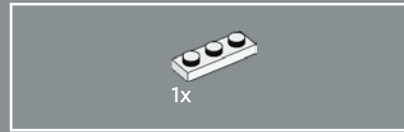
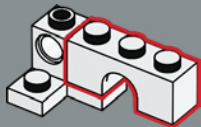

106

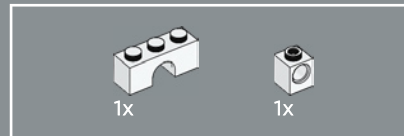
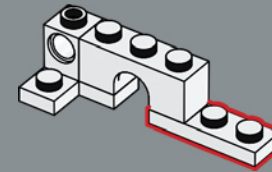

107

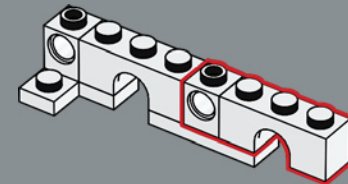

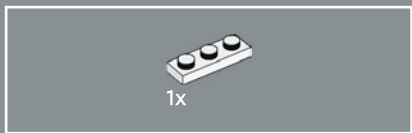

108

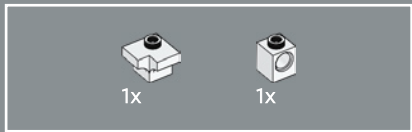
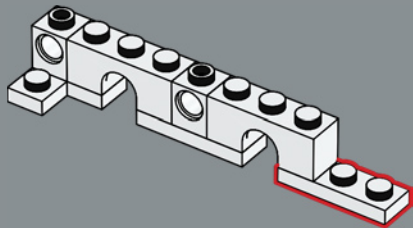

109

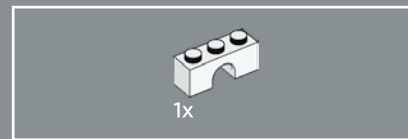
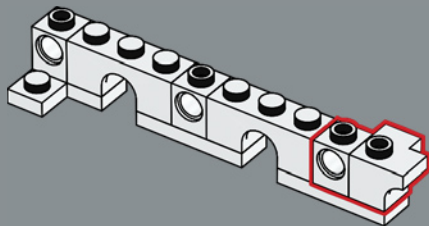

110

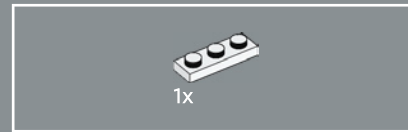
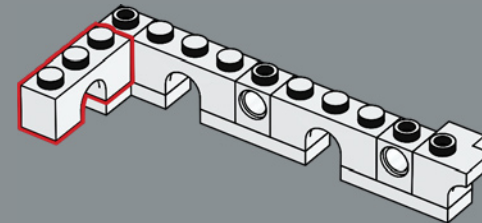

111

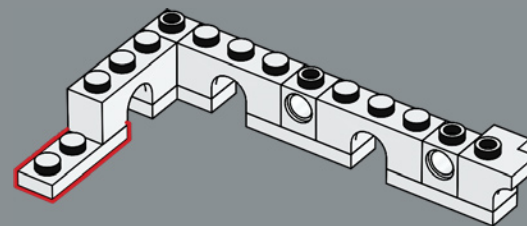

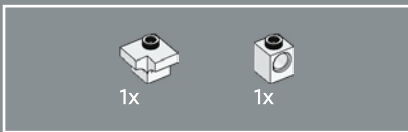

112

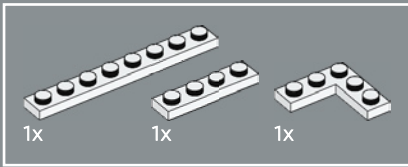
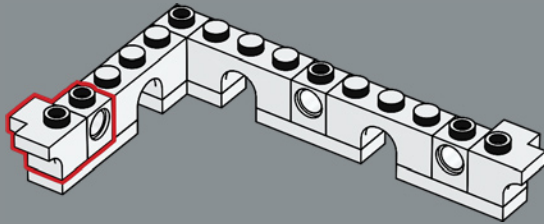

113

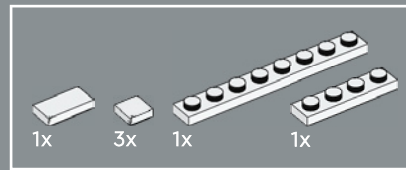
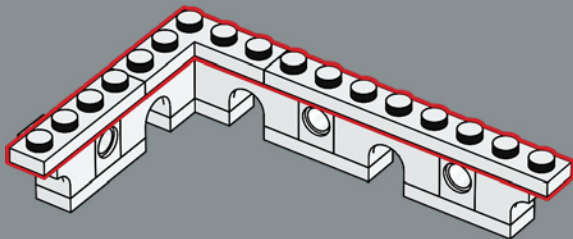

114

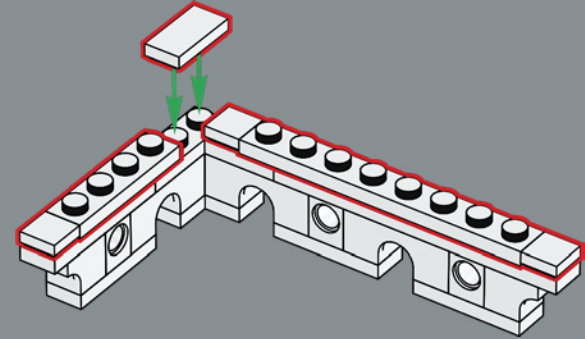

115

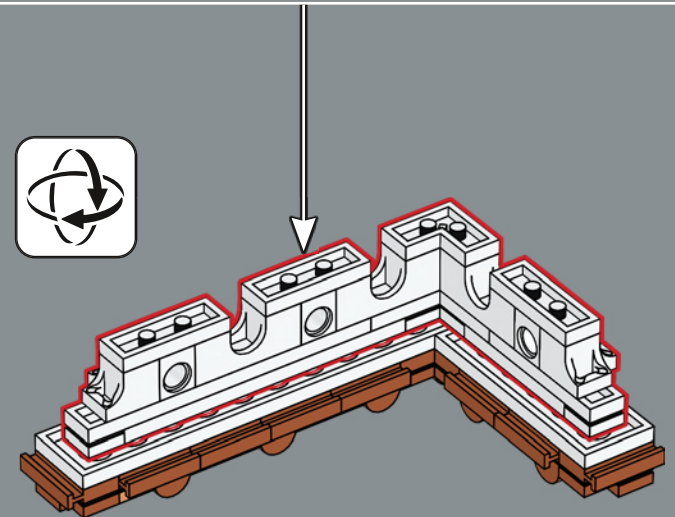

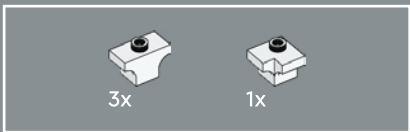

116

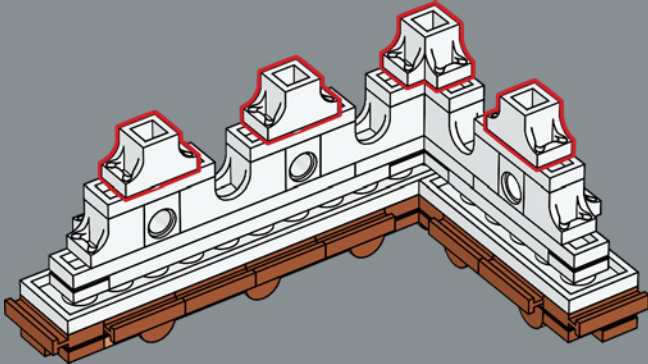

117

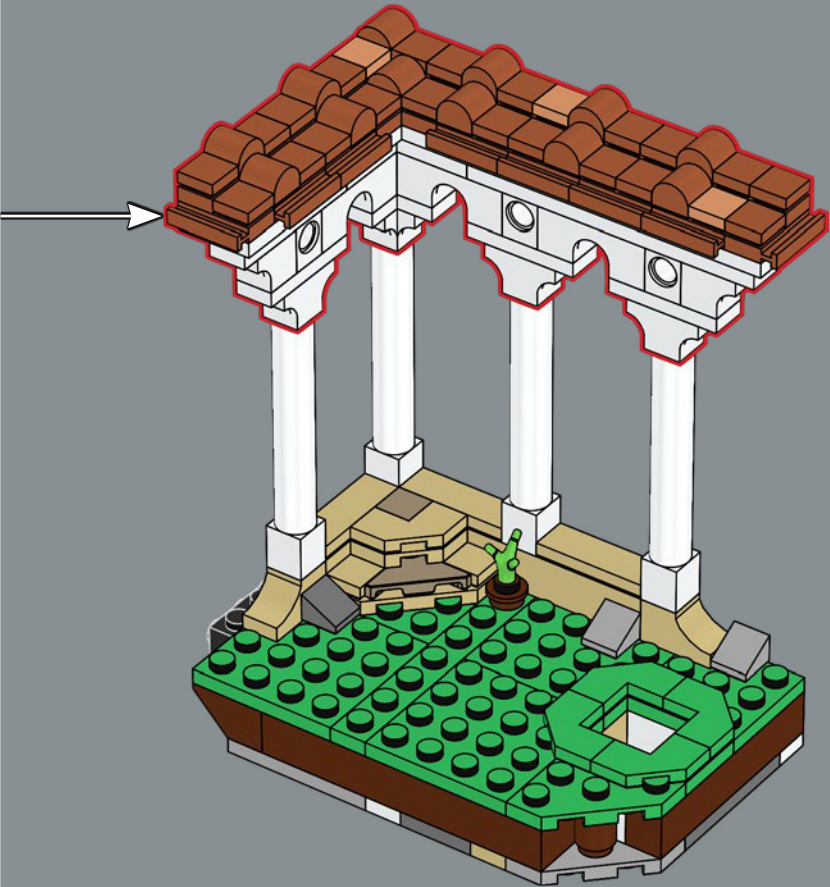

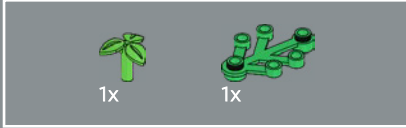

118

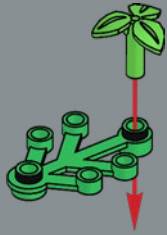

119

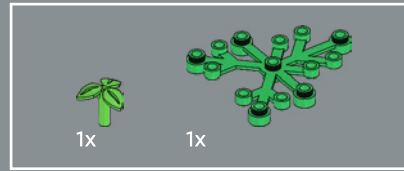

120

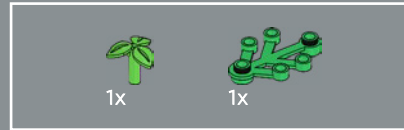
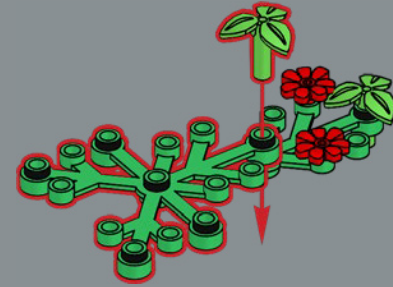

121

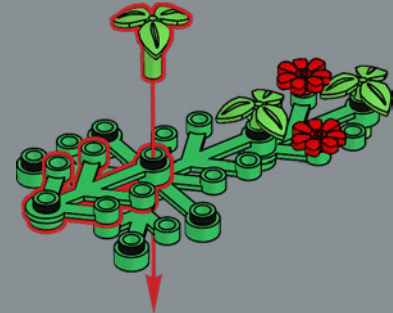



7x

122

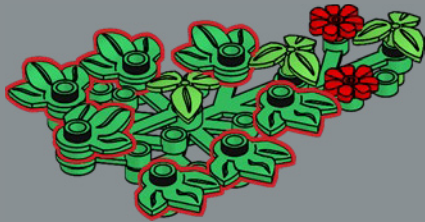

Red hibiscus flower (*Hibiscus rosa-sinensis*)
Hibiscus flowers can be used to test the acidity of a liquid.
A hibiscus flower will turn dark pink in acid, or green in base.
Perfect for checking the acidity of your fountain!



7x

123

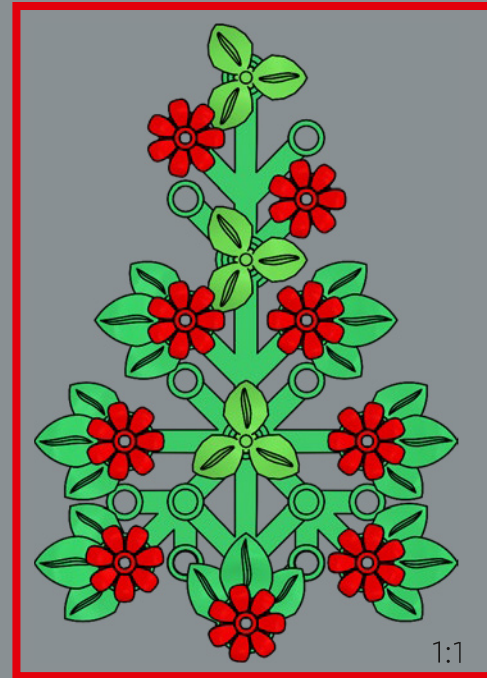
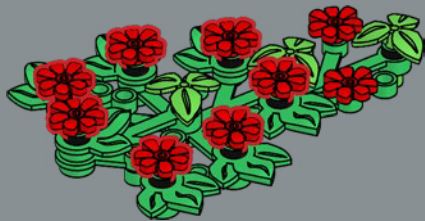



124

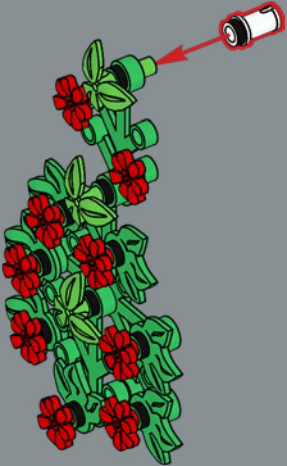

125

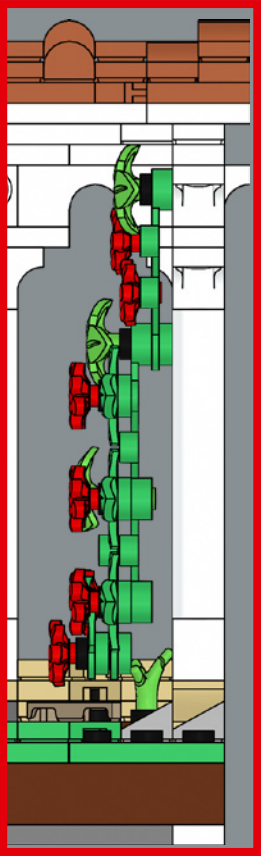

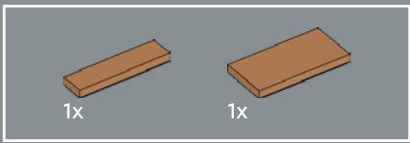

126

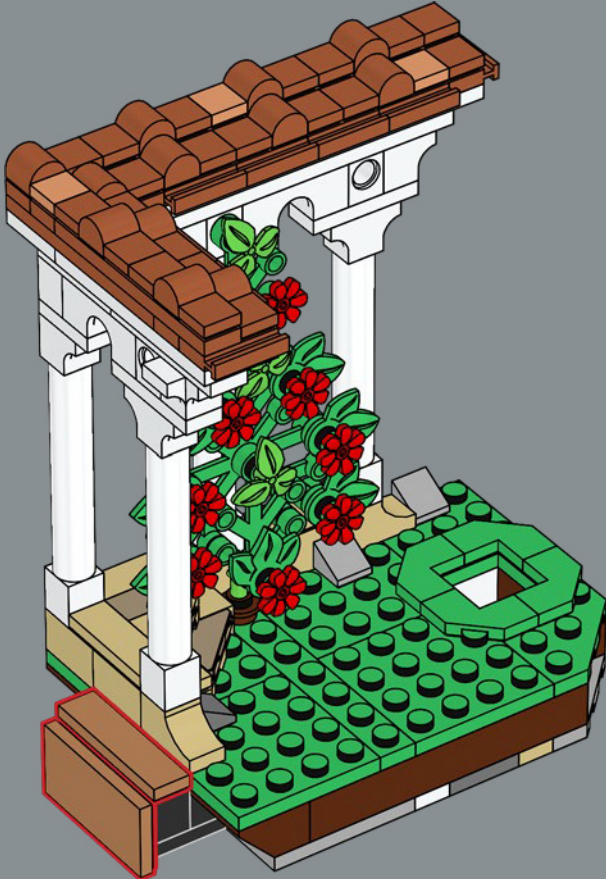

127



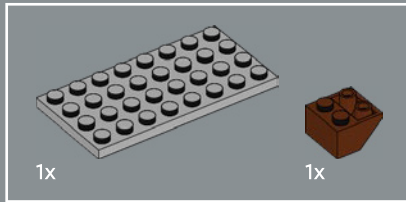
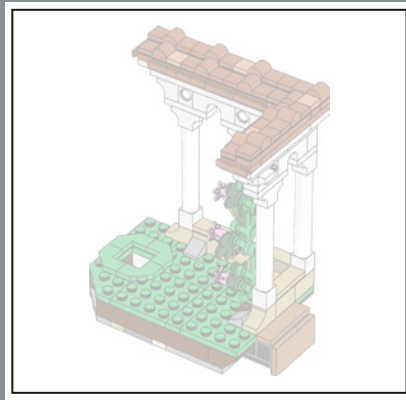

128

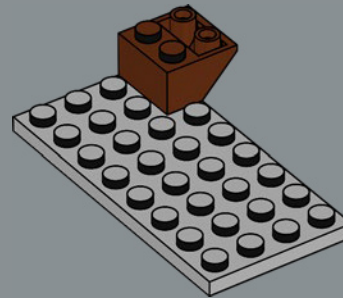

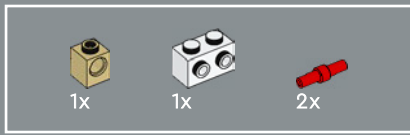

129

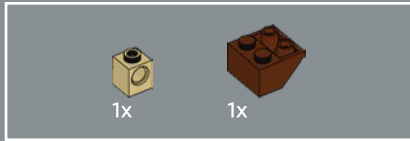
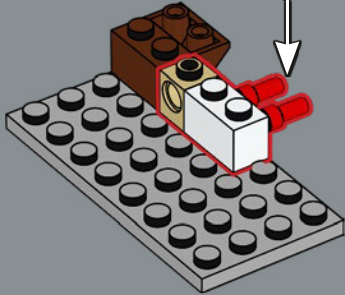
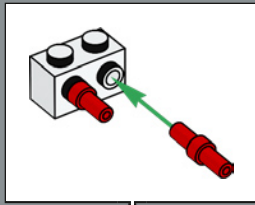

130

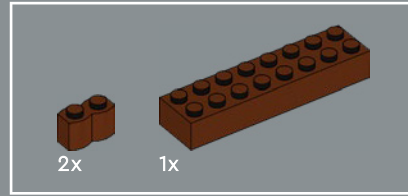
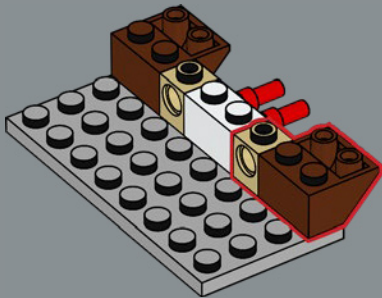

131

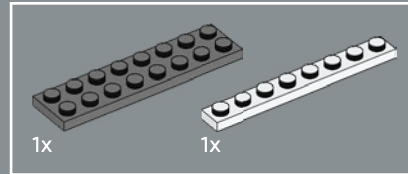
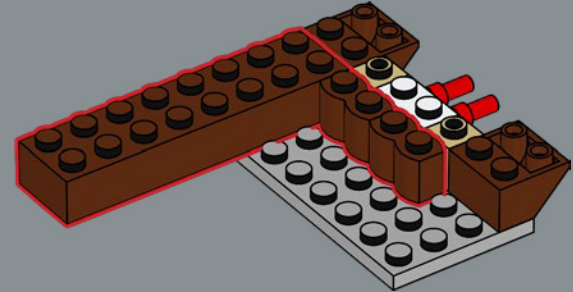

132

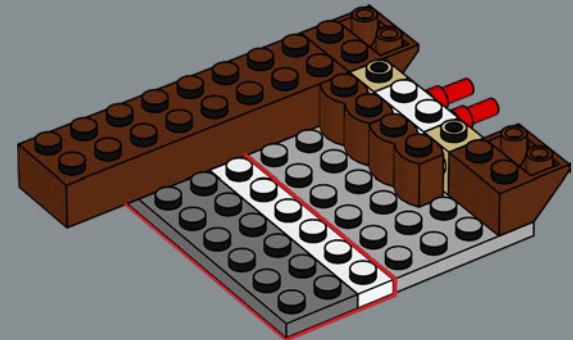

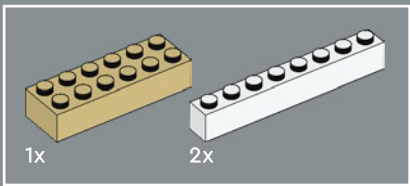

133

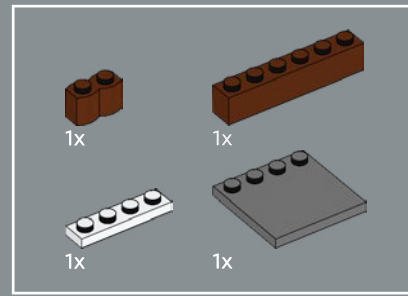
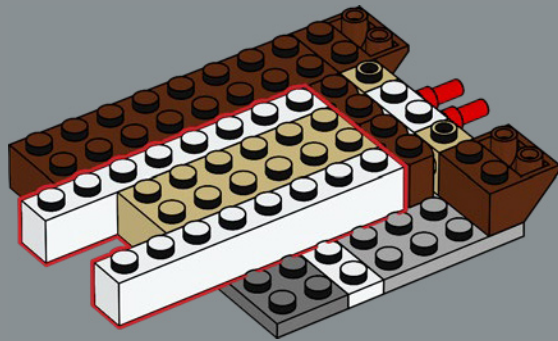

134

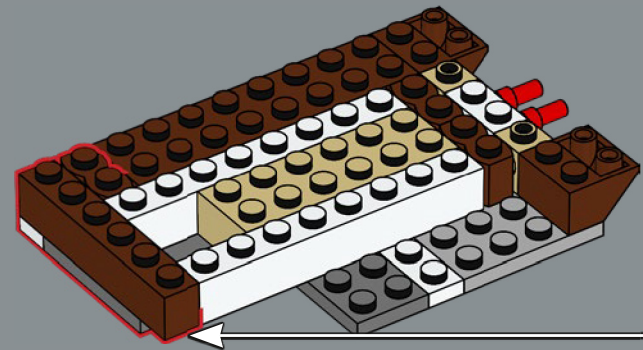
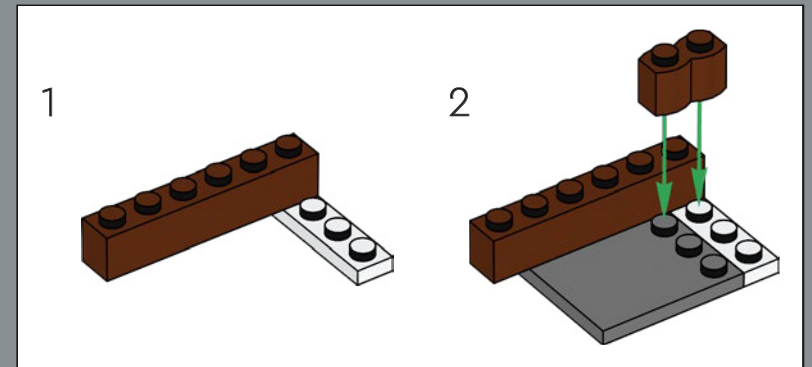

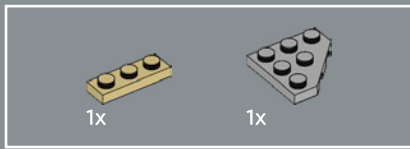

135

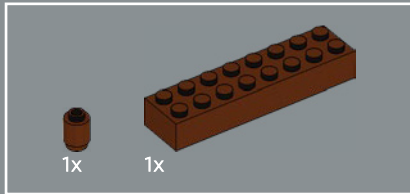
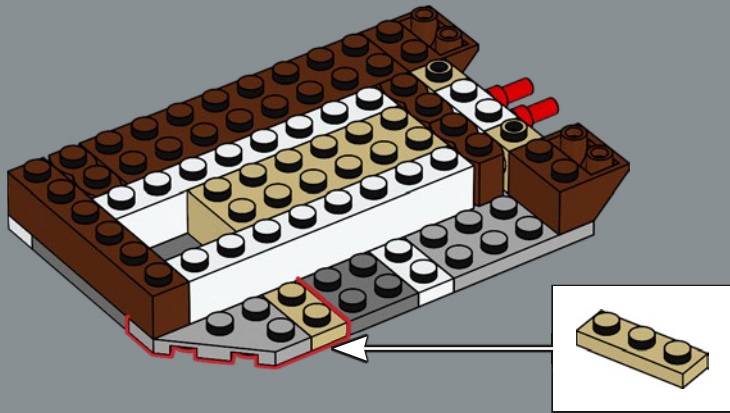

136

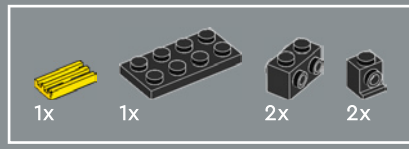
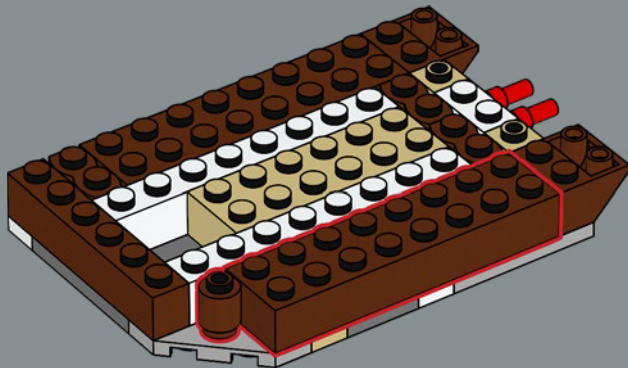

137

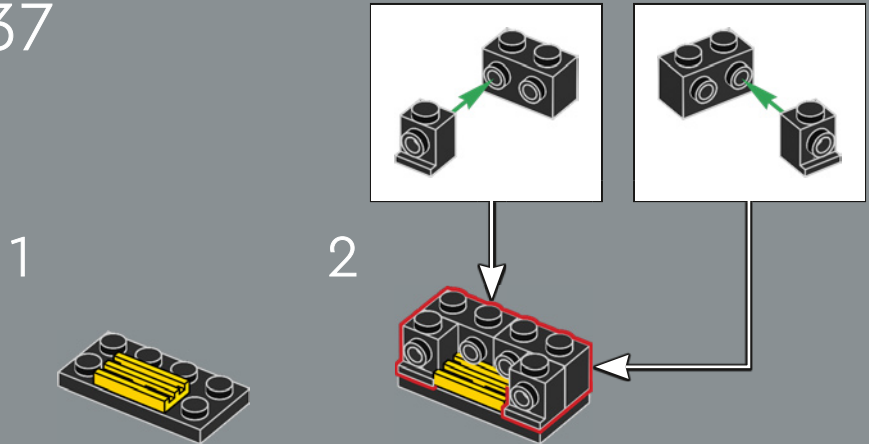

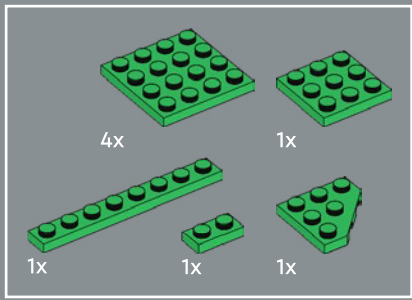

138

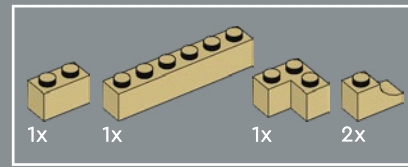
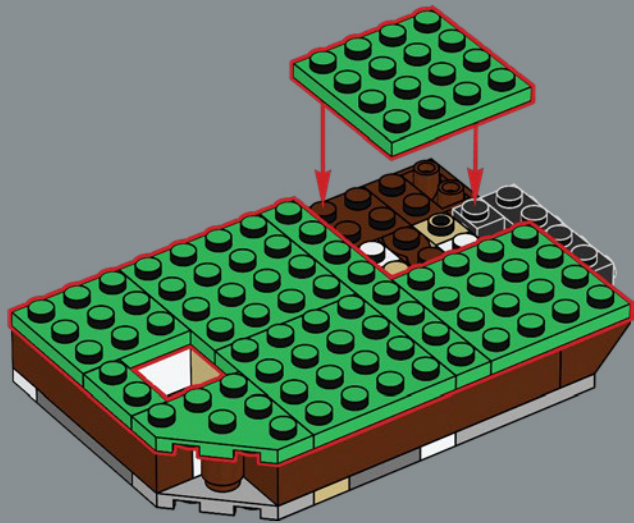

139



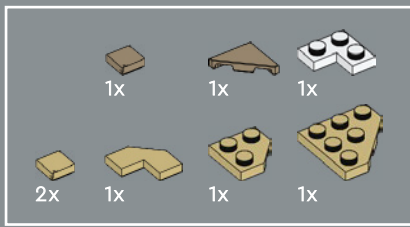

140

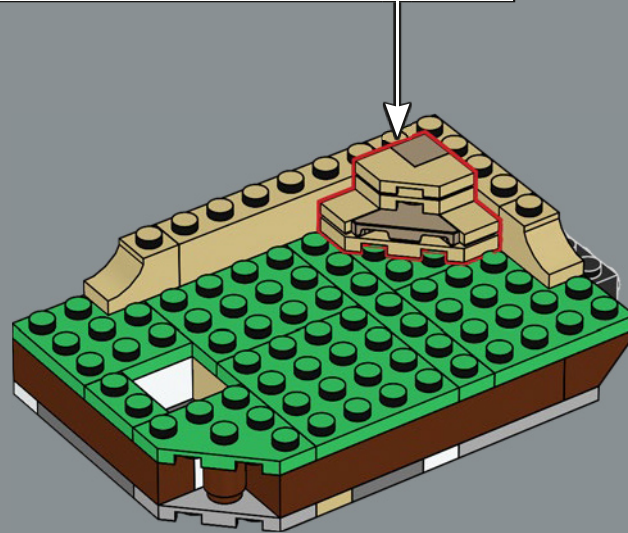
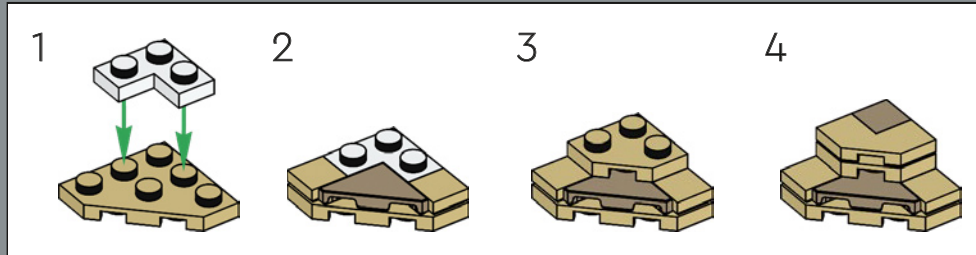

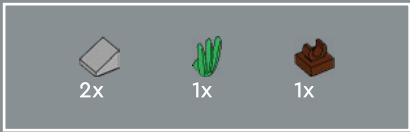

141

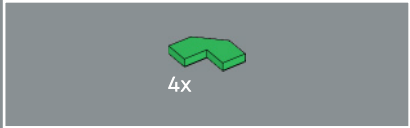
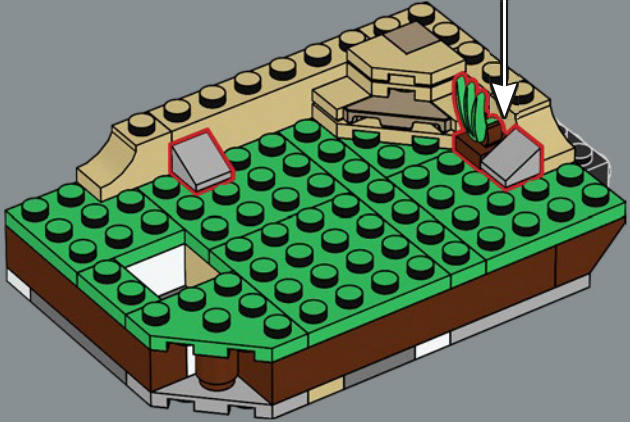
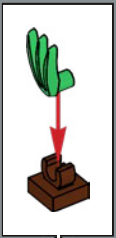

142

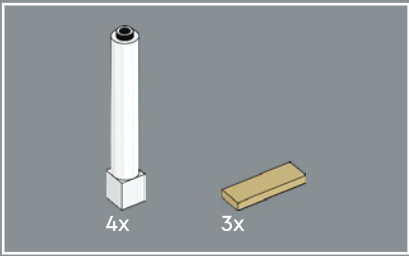
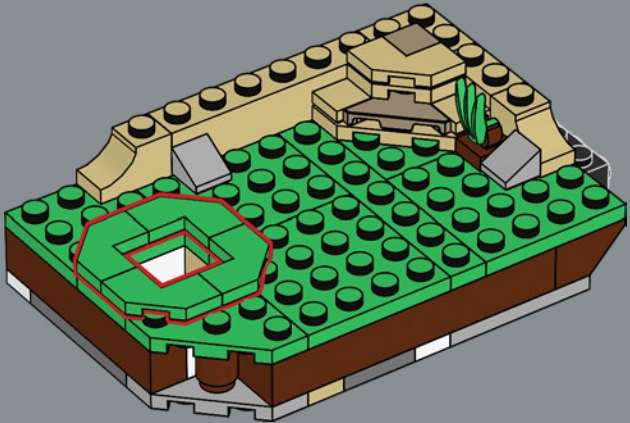

143

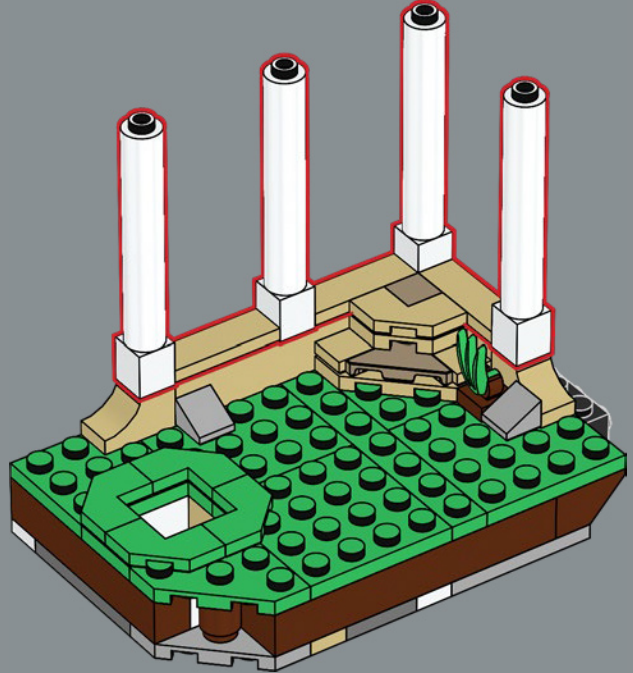

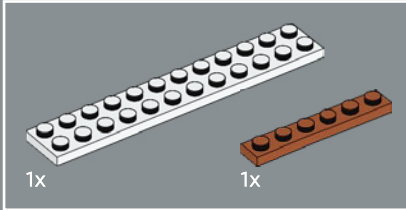
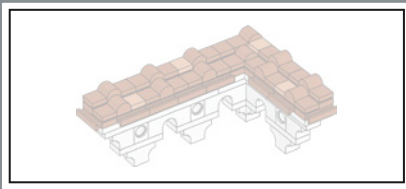

144

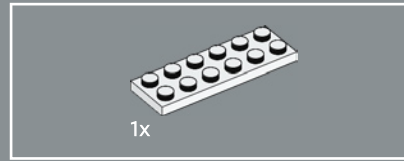
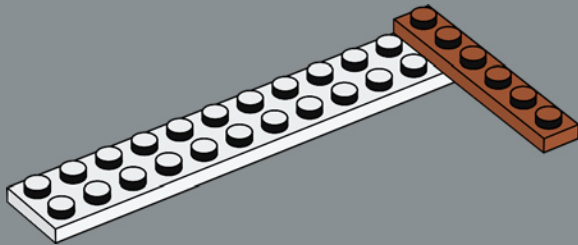

145

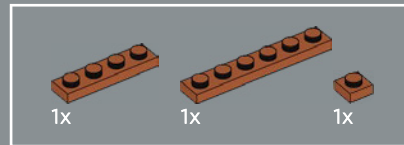
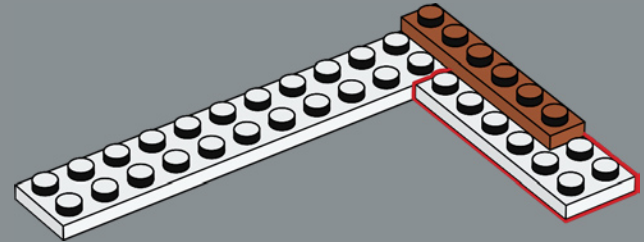

146

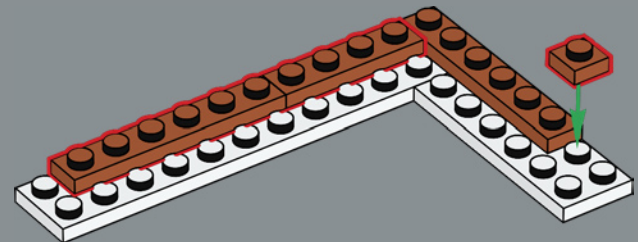



147

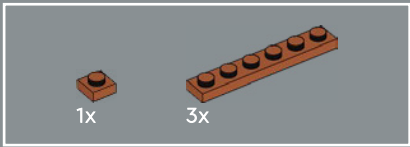
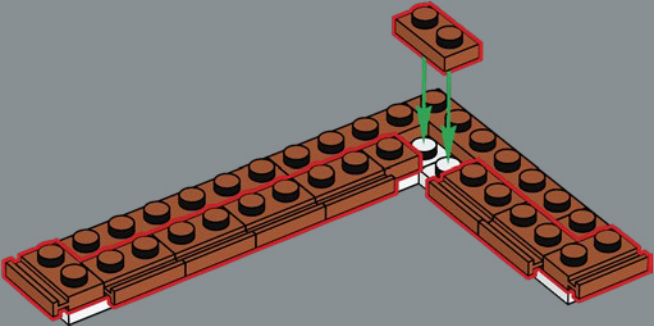

148

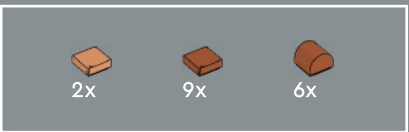
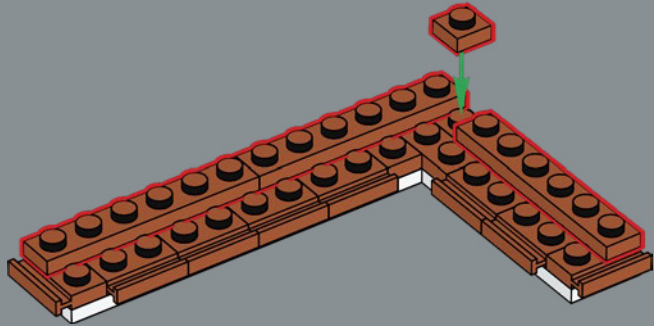

149

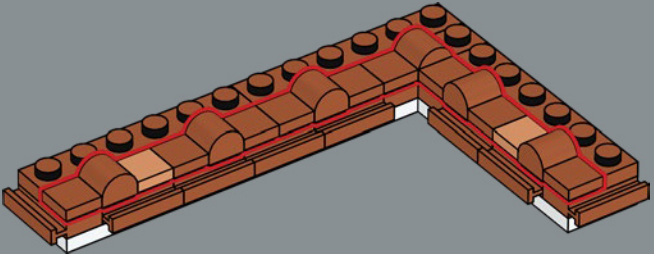

150

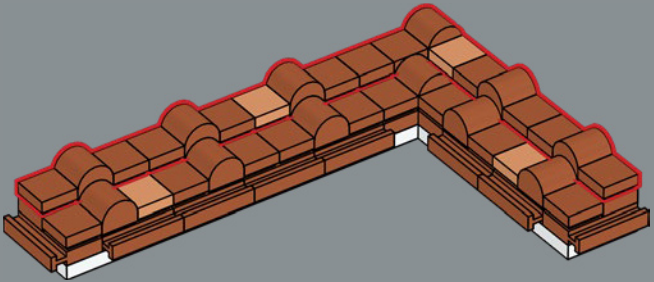

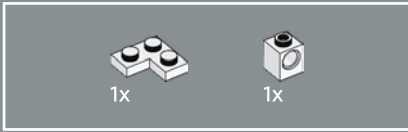
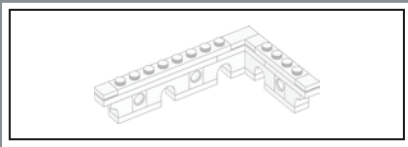

151

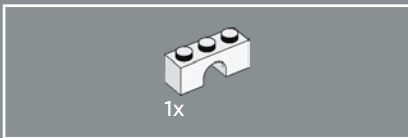
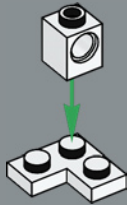

152

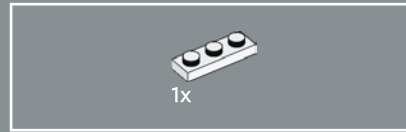
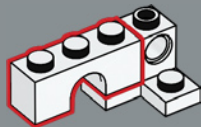

153

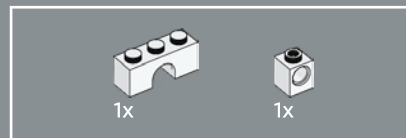
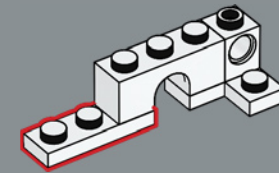

154

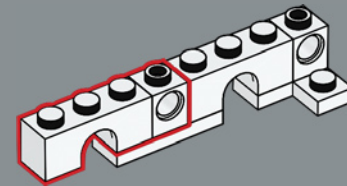

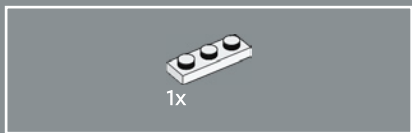

155

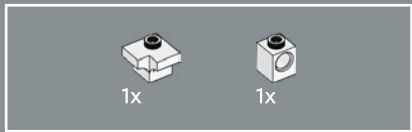
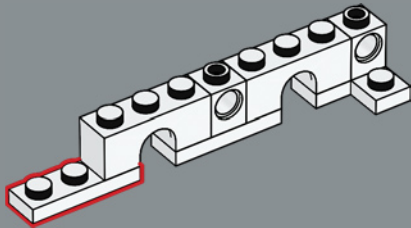

156

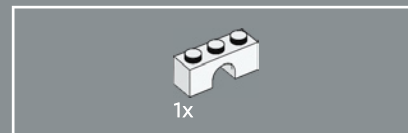
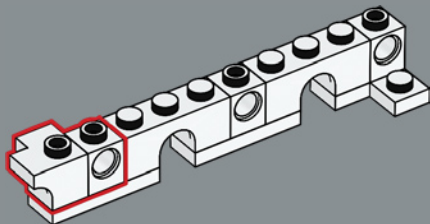

157

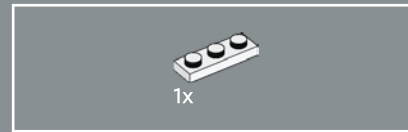
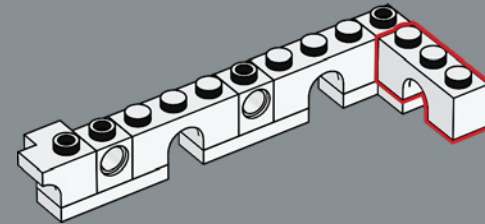

158

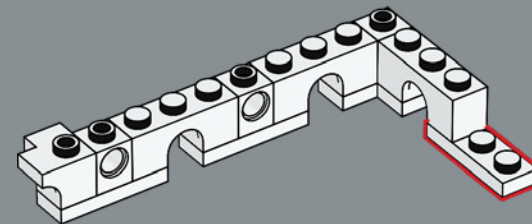

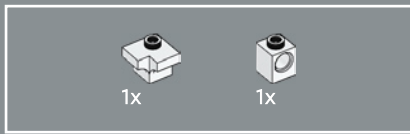

159

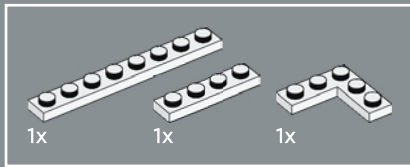
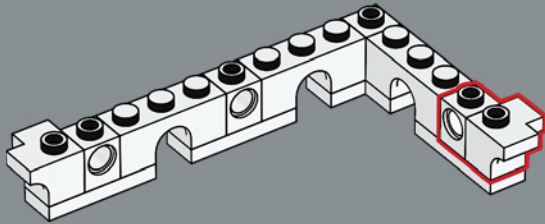

160

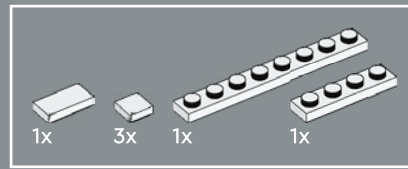
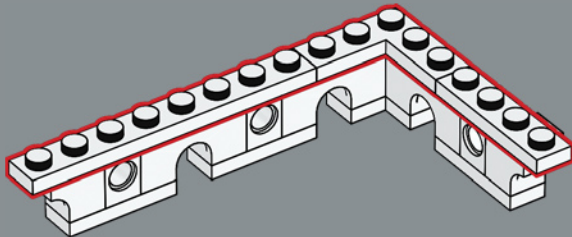

161

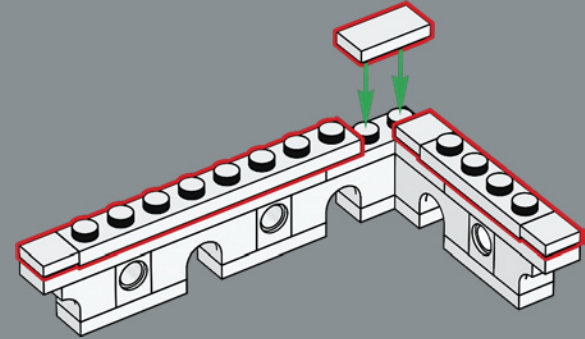

162

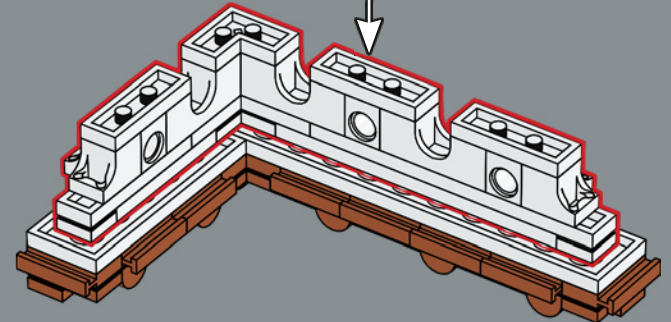

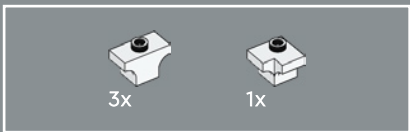

163

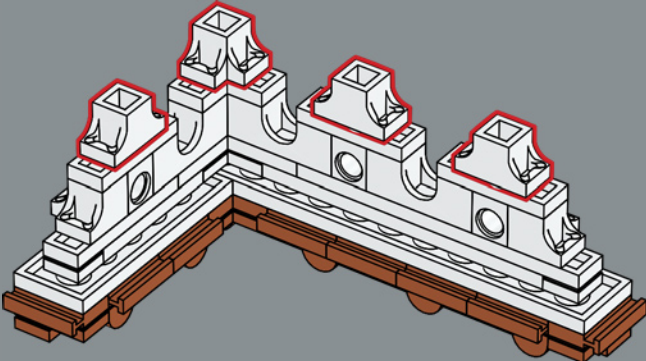

164

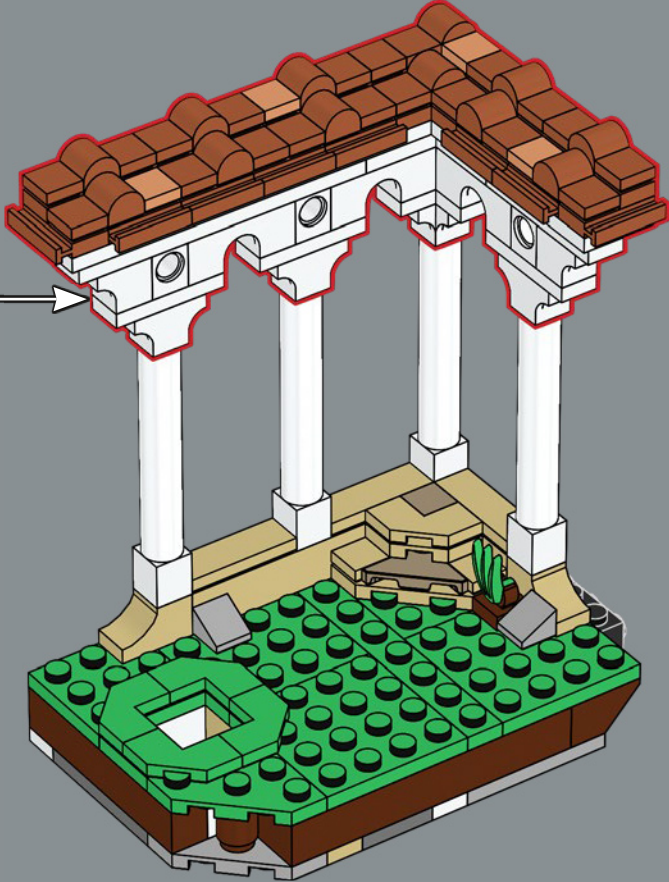

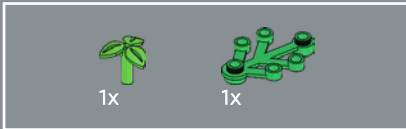
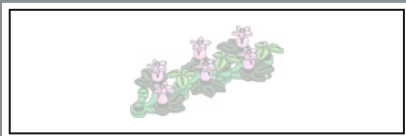

165

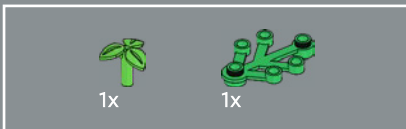
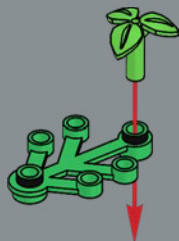

166

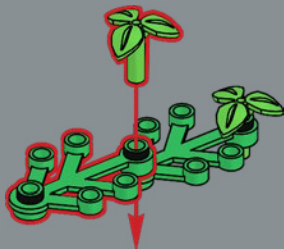

167

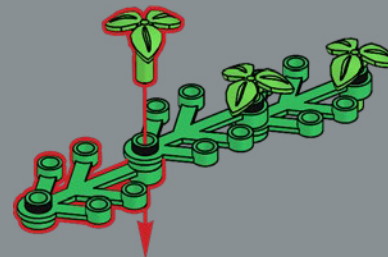

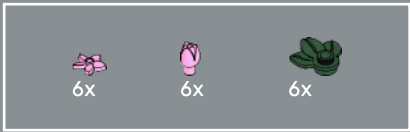

168

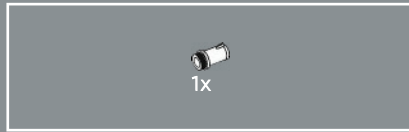
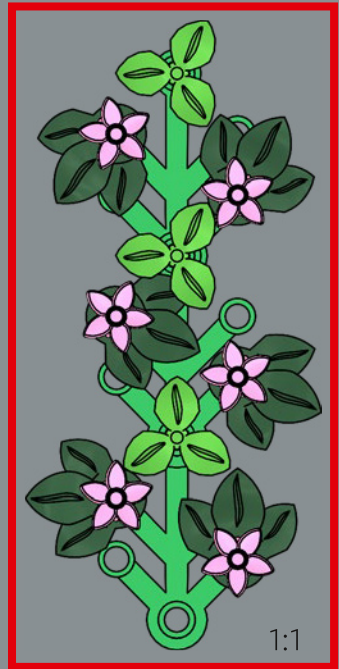
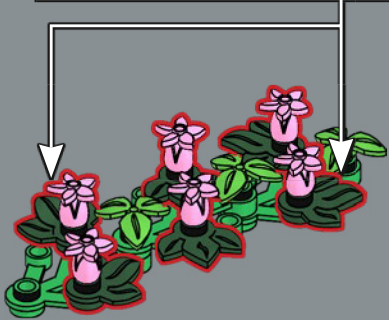
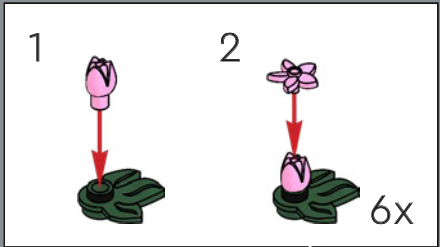

169

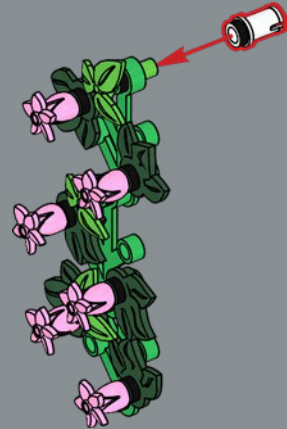

Pink bougainvillea flower (*Bougainvillea*)
 What most people think of as the 'flower' of bougainvillea are actually bracts or 'false flowers', which are a different type of leaf surrounding the real, tiny flowers on the plant.

170

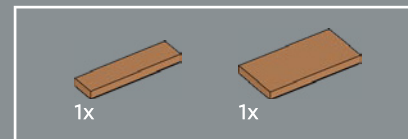
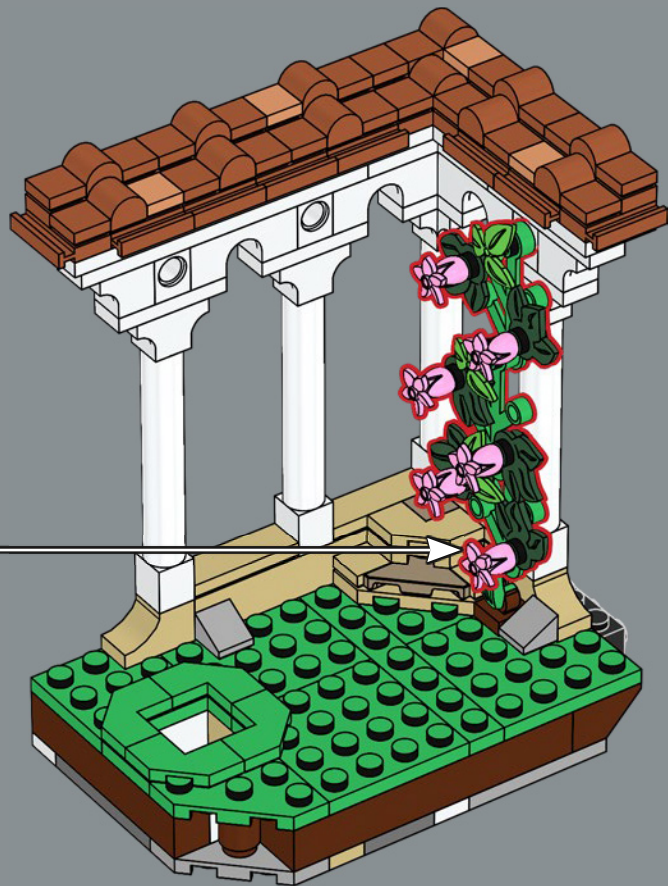

171





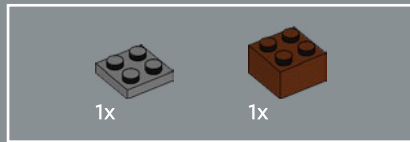
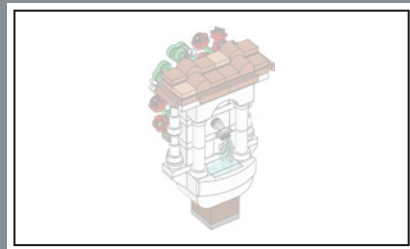

173

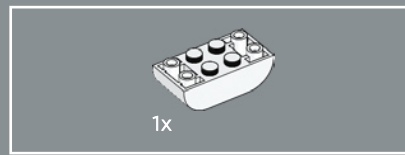
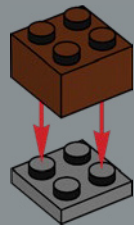

174

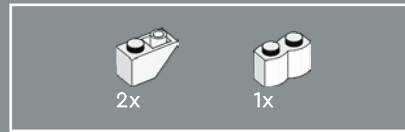
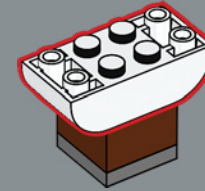

175

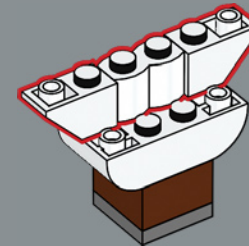

176

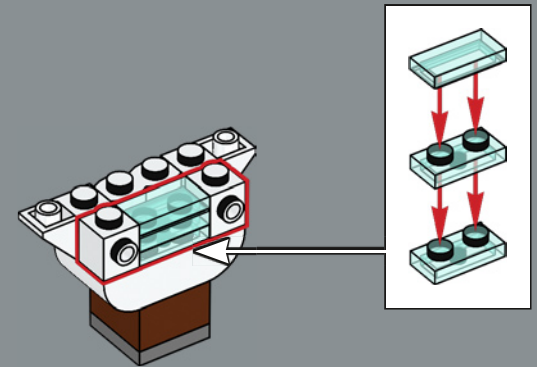



177

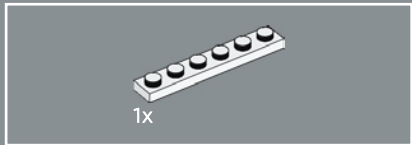
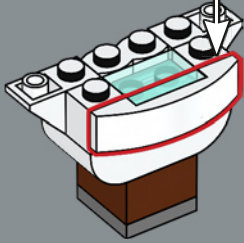
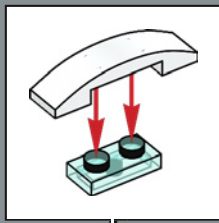

178

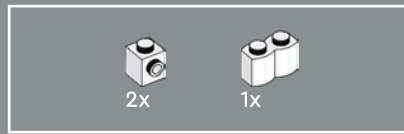
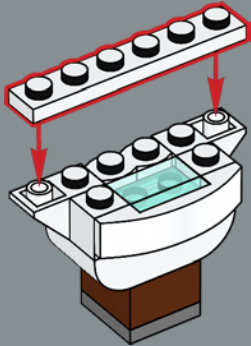

179

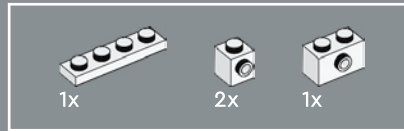
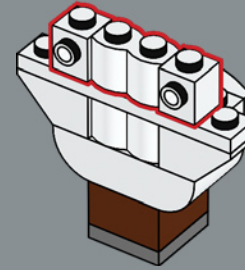

180

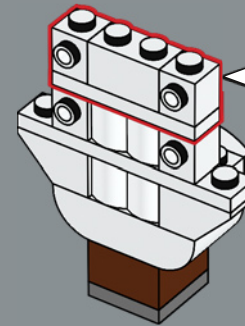
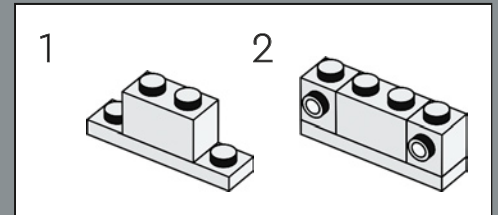

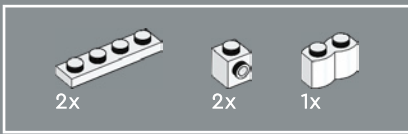

181

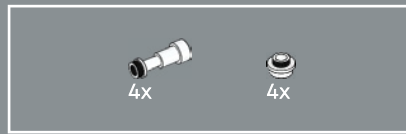
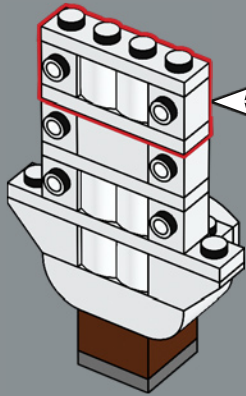
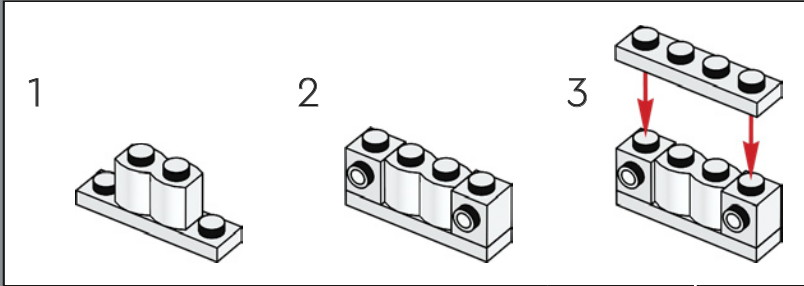

182

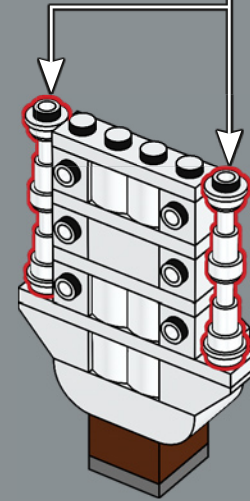
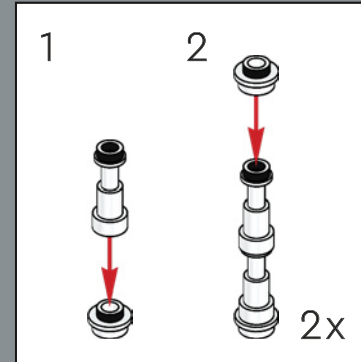



183

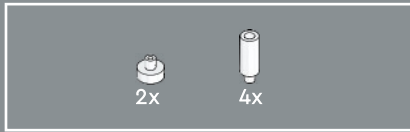
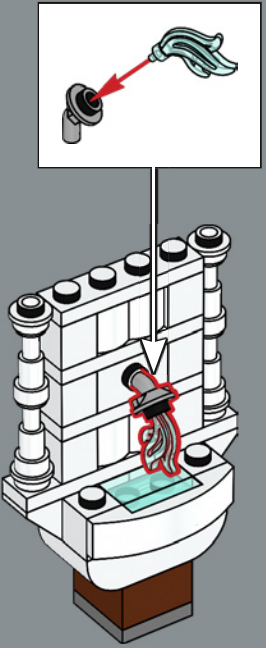

184

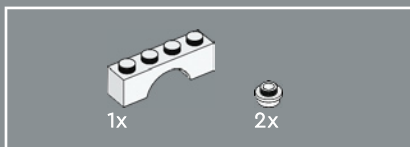
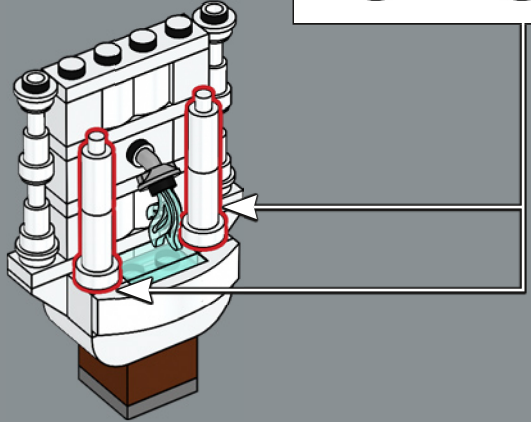
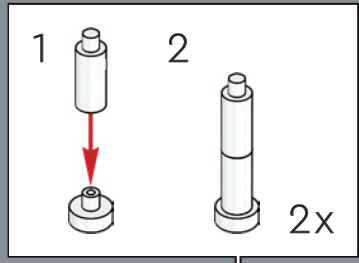

185

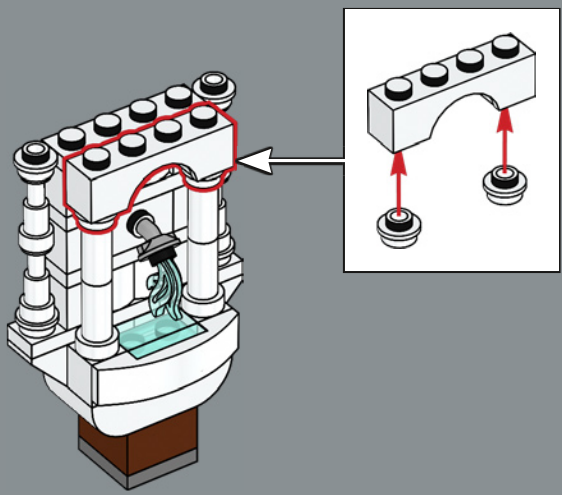

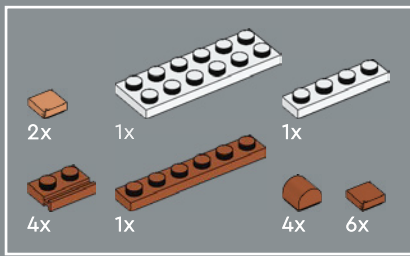

186

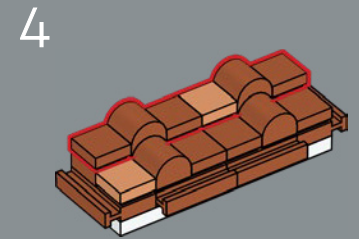
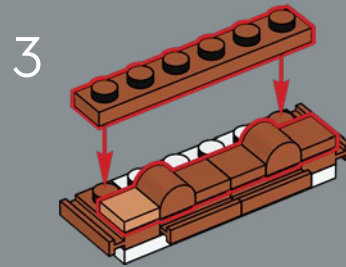
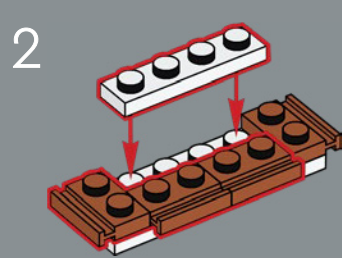
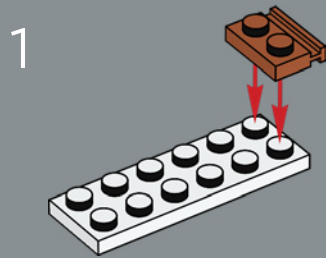



2x

187

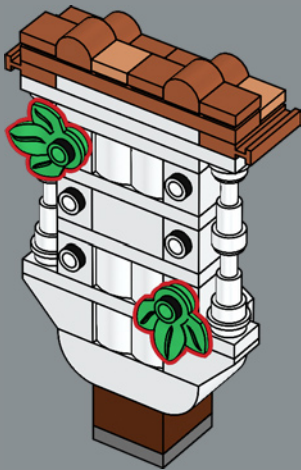

2x

188

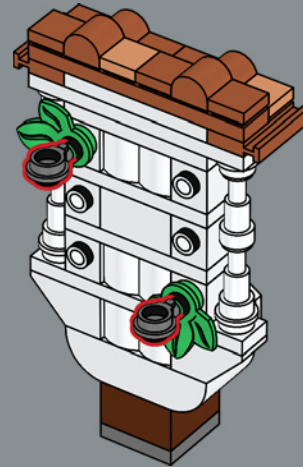

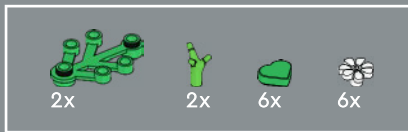

White petunia (*Petunia axillaris*)
 Although some petunia species can be used as a garnish,
 perhaps it's better to leave this beauty to blossom in
 your garden. It is closely related not only to potatoes and
 tomatoes, but also to deadly nightshade!

189

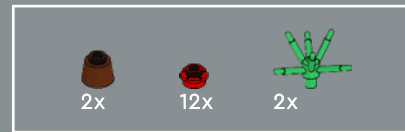
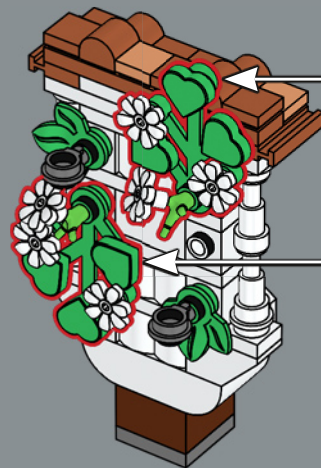
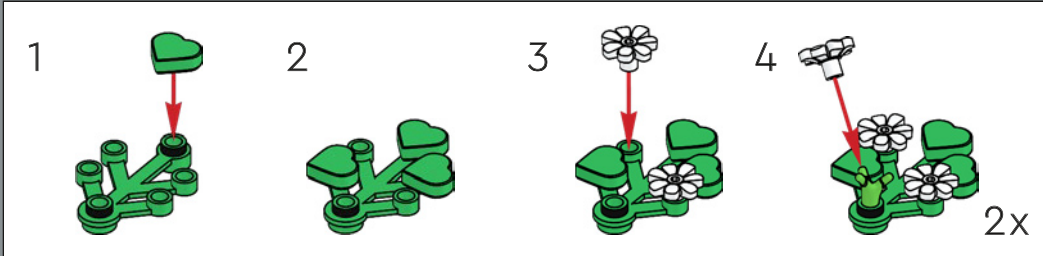

190

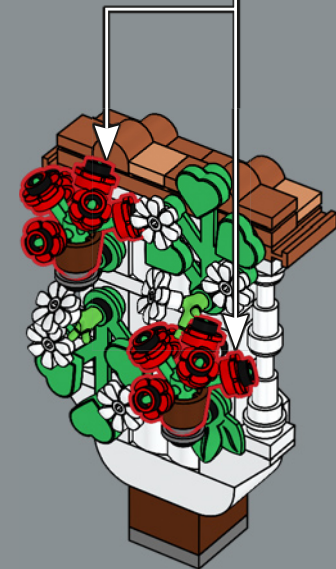
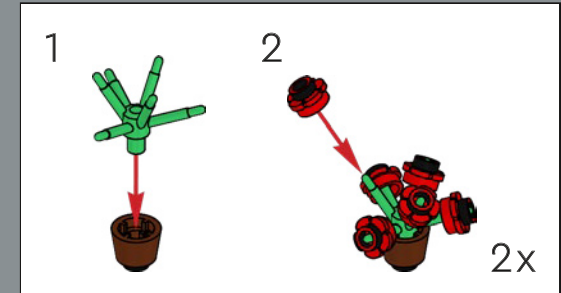

Red garden geranium (*Pelargonium x hortorum*)
 The fragrant garden geranium serves both aesthetic and practical purposes in
 a serene garden. Its natural oils give off a scent that sends insects packing!



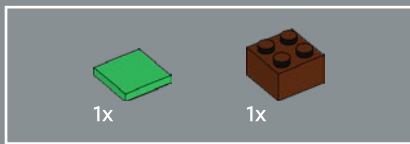

192

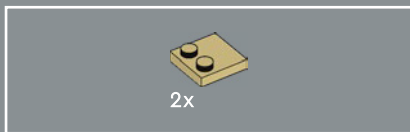
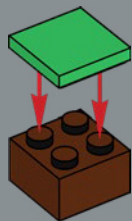

193

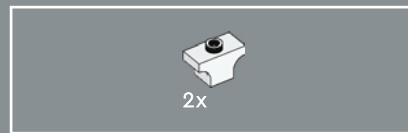
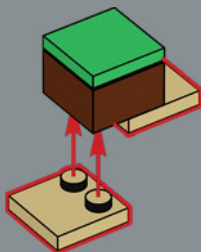

194

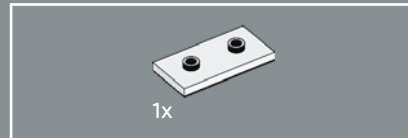
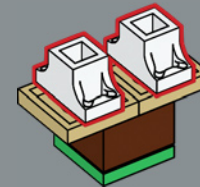

195

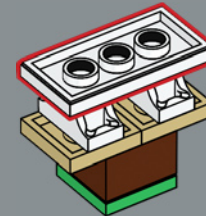

196

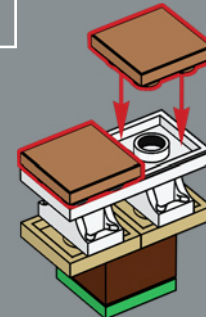



Iberian waterfrog (*Pelophylax perezi*)
Native to the Iberian Peninsula, this swift little swimmer
thrives in freshwater habitats and wetlands.

197



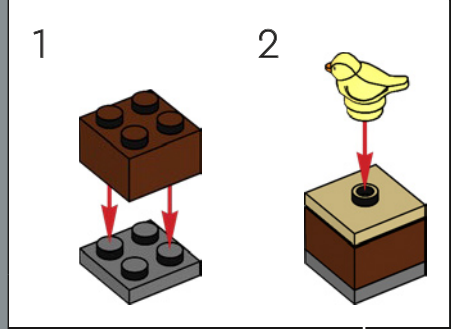
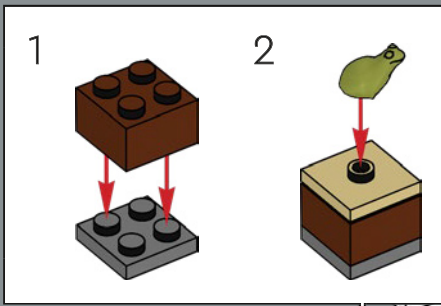
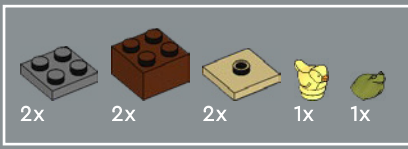

Yellowhammer (*Emberiza citrinella*)
 The yellowhammer, with its characteristic bright yellow plumage and distinctive song, is found throughout Europe.

198



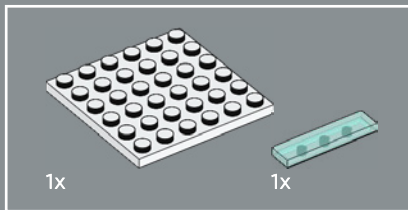
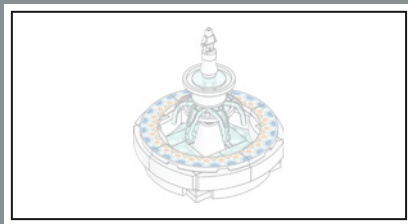

199

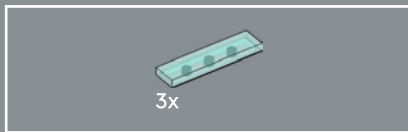
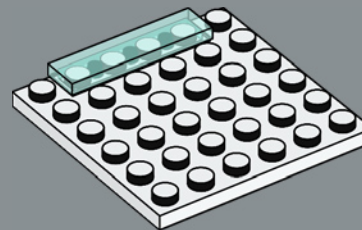

200

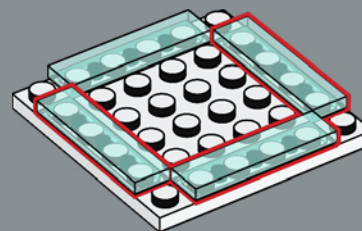

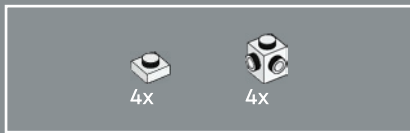

201

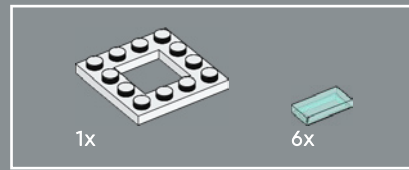
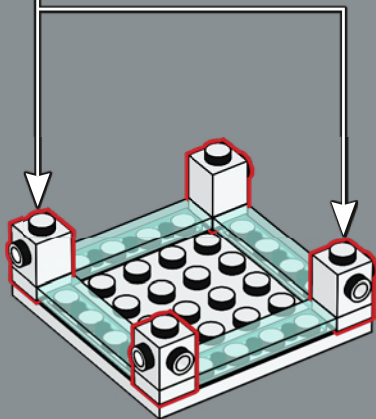
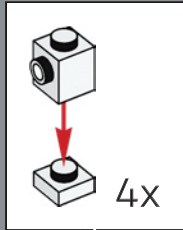

202

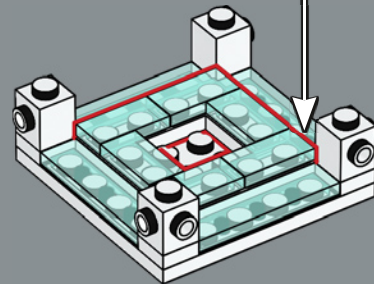
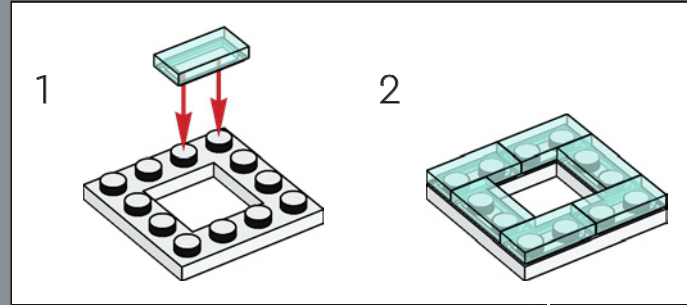

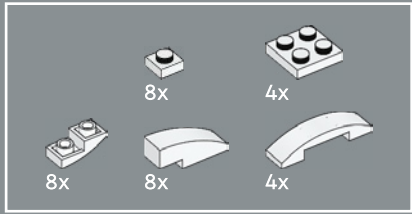
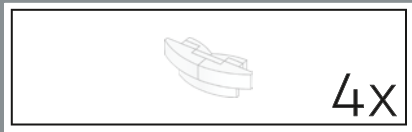

203

1

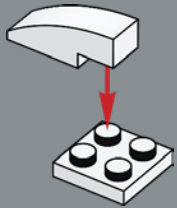

2

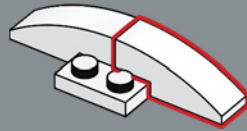

3

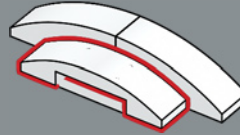

4

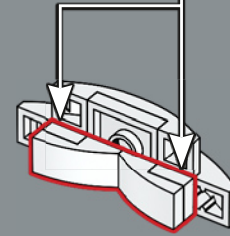
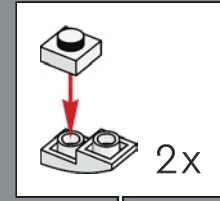

4x

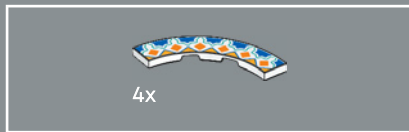

204

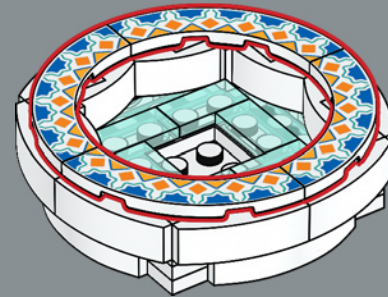
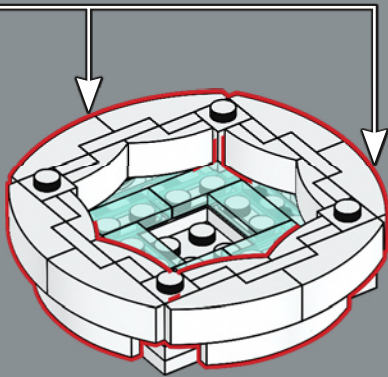

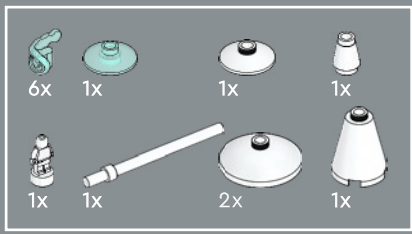

205

1

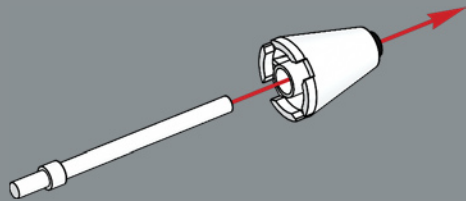

2



3



4



5

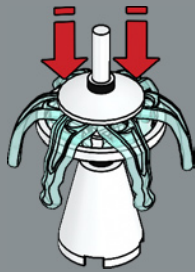

6

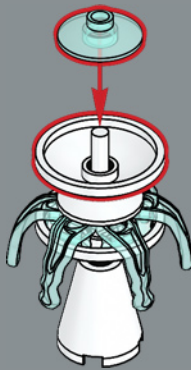

7

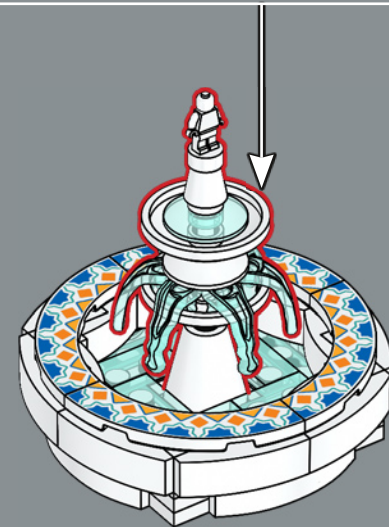
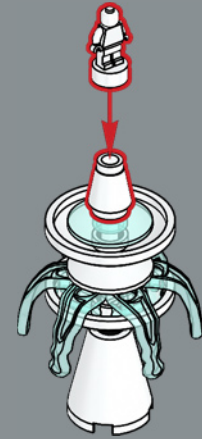



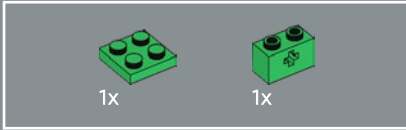

207

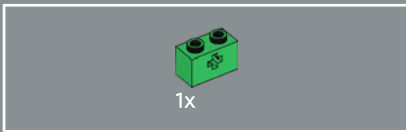
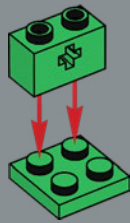

208

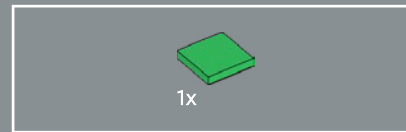
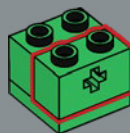

209

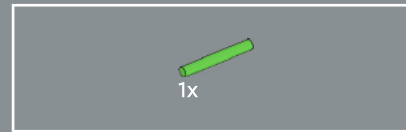
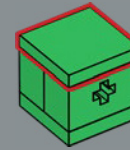

210

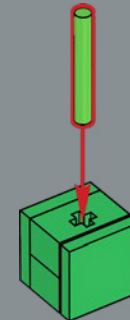

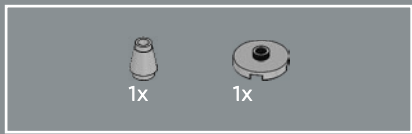

211

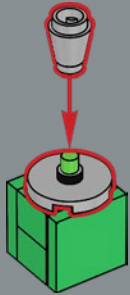

212

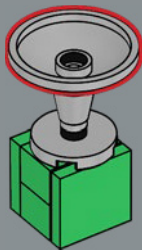

213

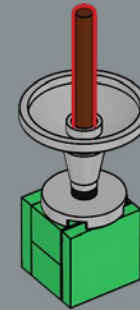



214

1



2

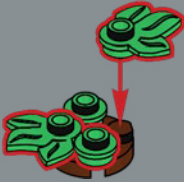

3

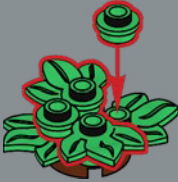

4

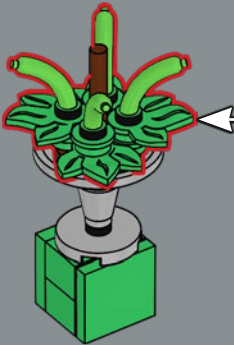

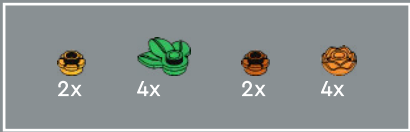

215

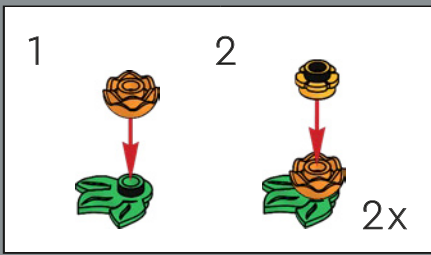
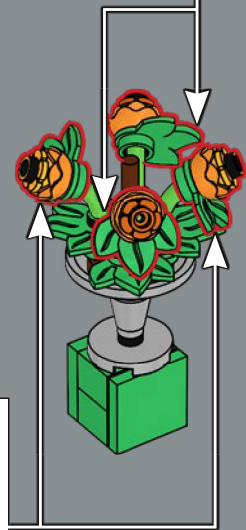
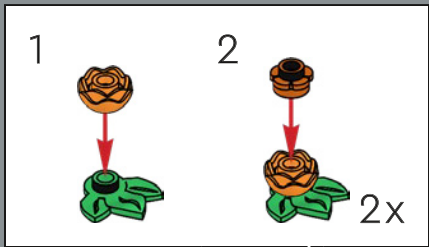

216

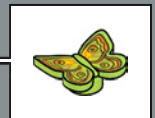
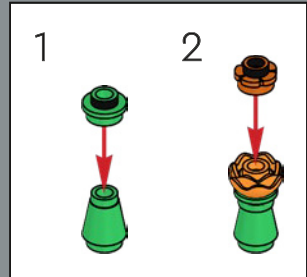

Spanish moon moth (*Graellsia isabellae*)
 The Spanish moon moth, a stunning species with green wings and unique eyespots, thrives in the Pyrenees. A 'relic' species, it has remained largely unchanged since the last Ice Age.



217

French marigold (*Tagetes patula*)
Marigolds originate from Central America, but these aromatic little rays of sunshine are loved by gardeners and chefs around the world as decoration or a tangy twist to sweet deserts.



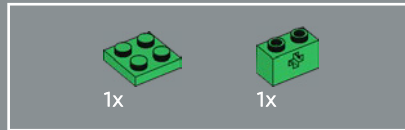
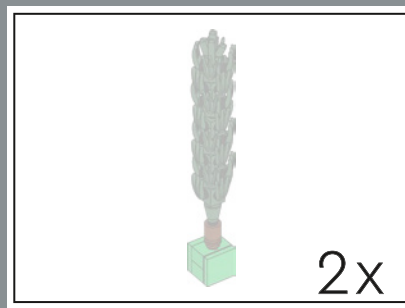

218

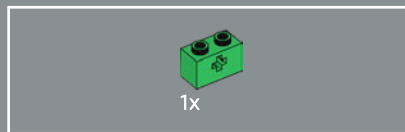
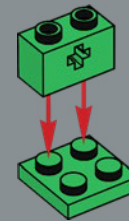

219

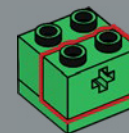

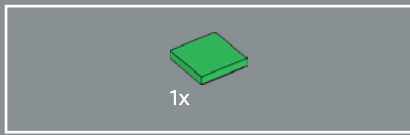

220

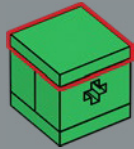

221

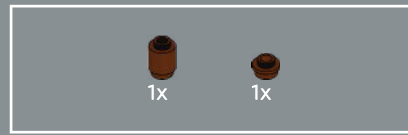
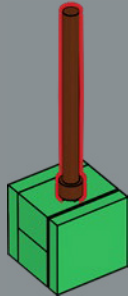

222

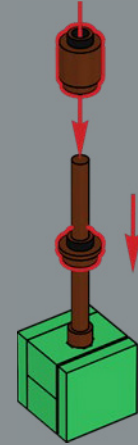

223

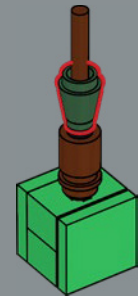

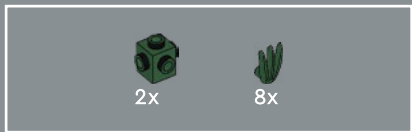

224

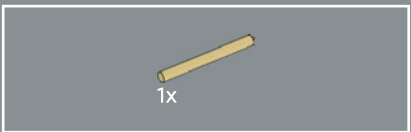
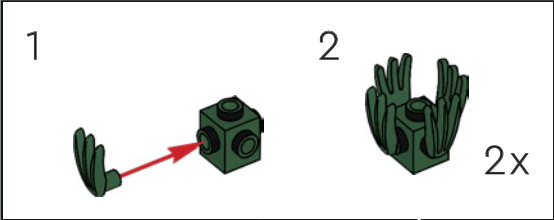

225





226

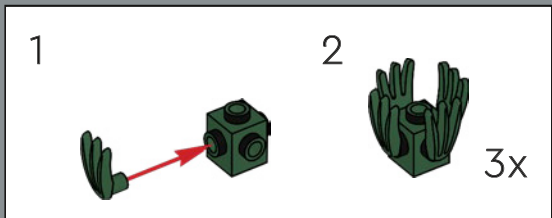

227





228

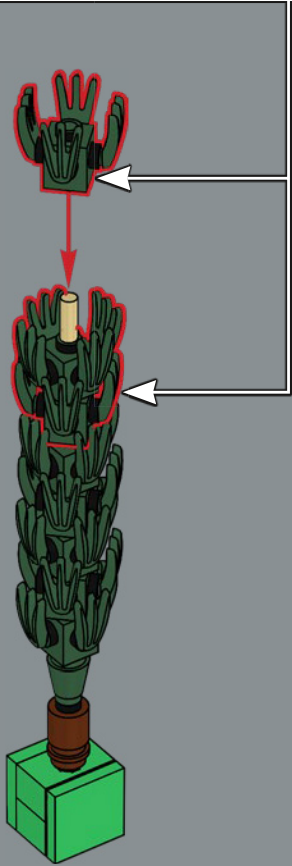
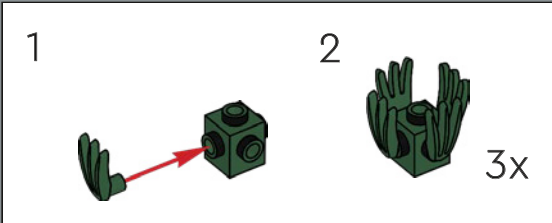

229



Cypress (*Cupressus sempervirens*)
With their distinctive shape and beauty, cypress trees are a common sight in Mediterranean landscapes. Did you know that their aromatic oil is a valuable ingredient in health remedies and beauty products?



2x



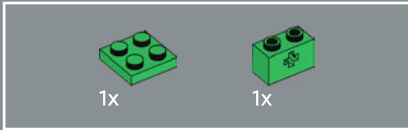
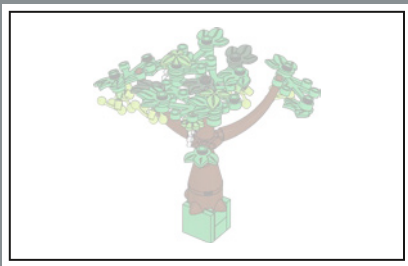

231

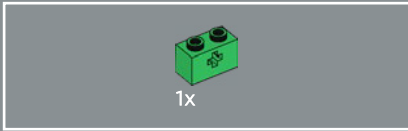
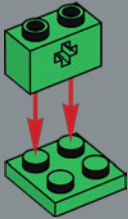

232

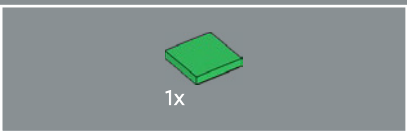
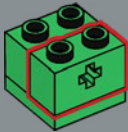

233

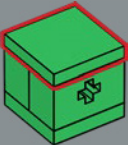

Grapevine (*Vitis vinifera*)
A deliciously sweet and juicy food staple, grapes were first cultivated by ancient civilisations more than 10,000 years ago.

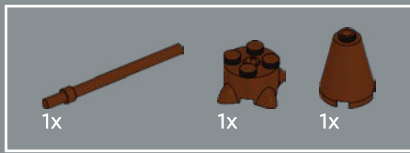

234

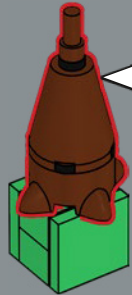
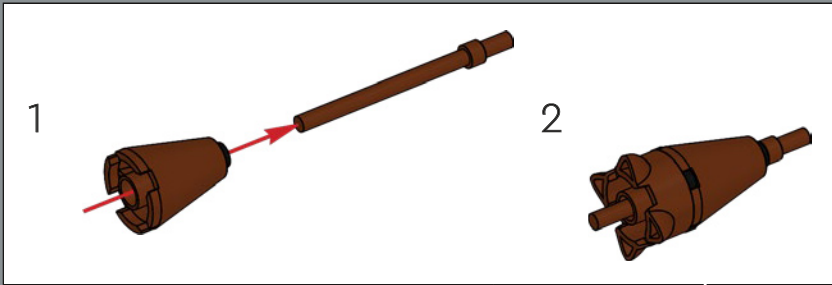

235

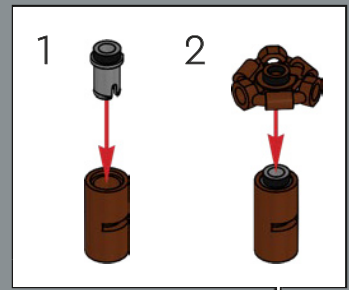

236





237

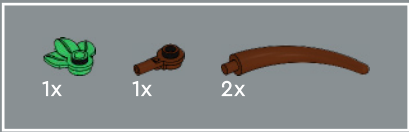

238

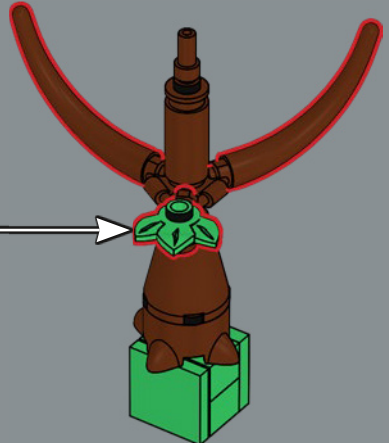
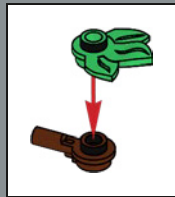

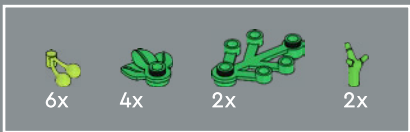

239

1

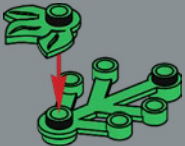

2

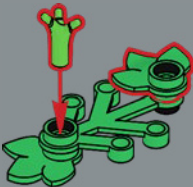

3

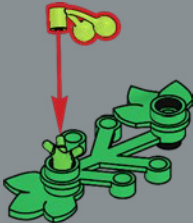

4

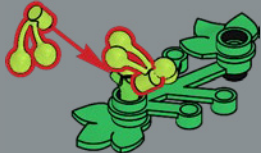

2x

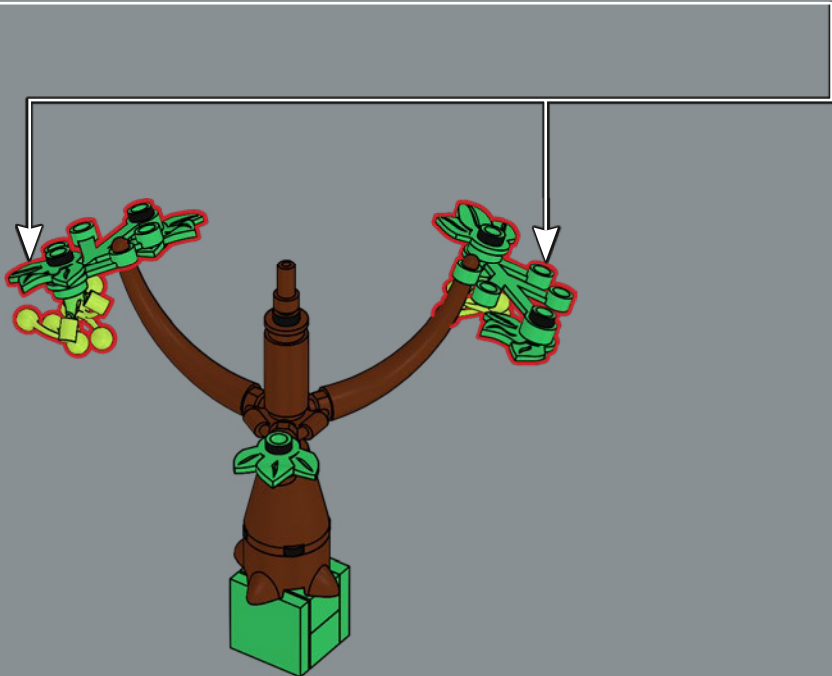

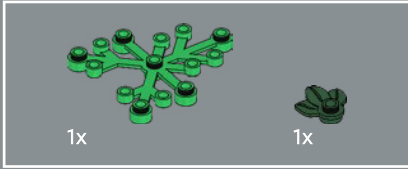
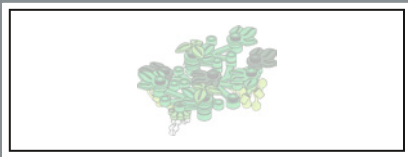

240

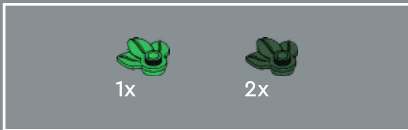
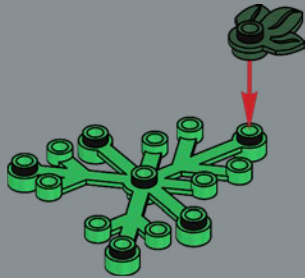

241

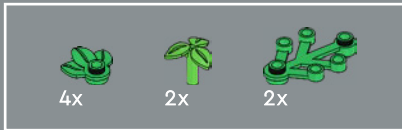
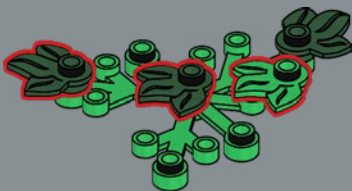

242

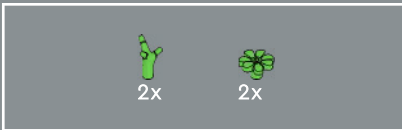
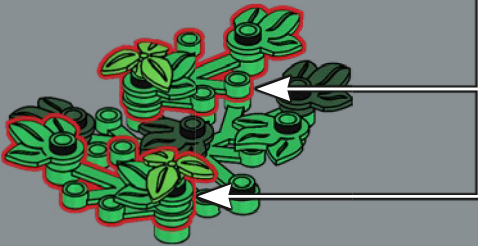
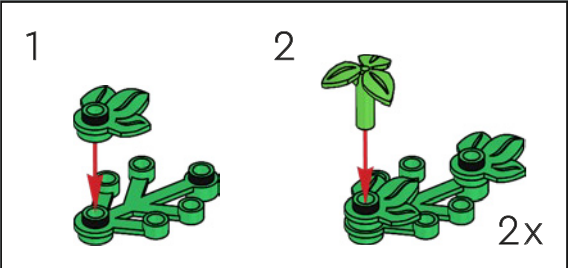

243

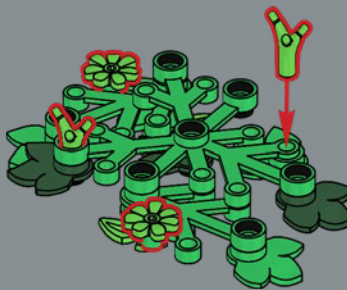



244

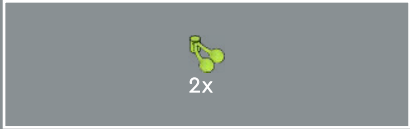

245

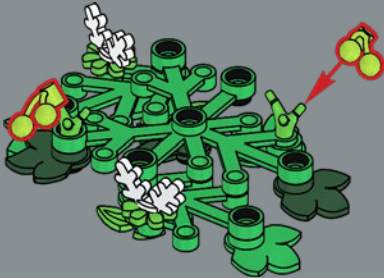

246



247





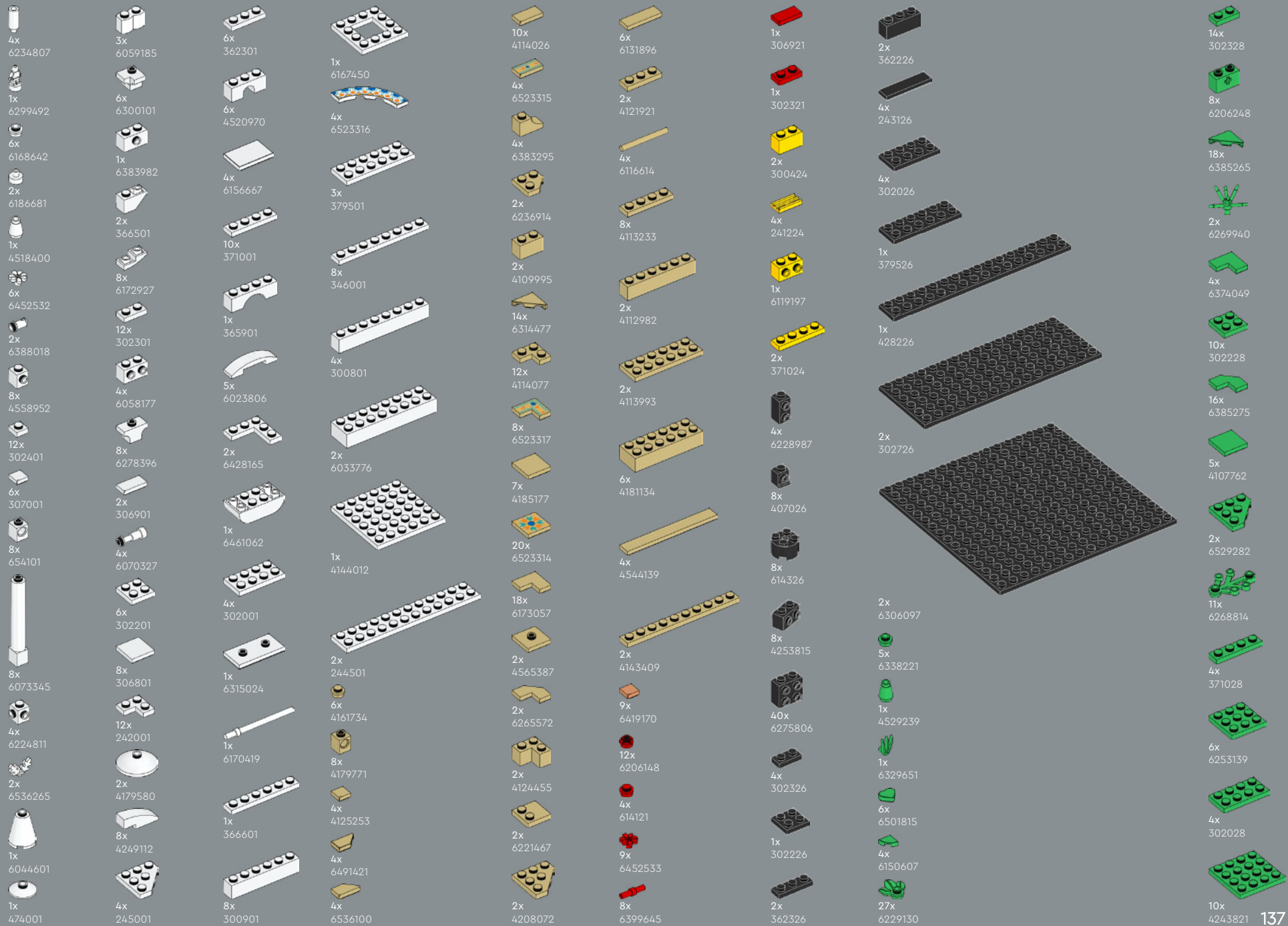



2x
6266968

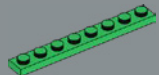

2x
346028

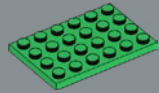

6x
4116671

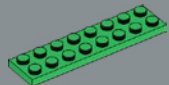

2x
303428



7x
6434871



2x
6488792



4x
6430093



8x
6235080



1x
6161772

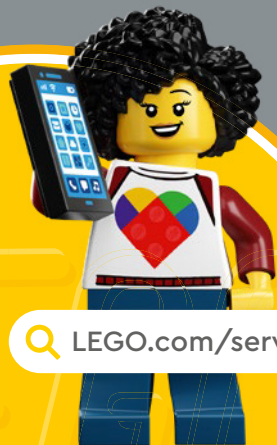

[LEGO.com/service](https://www.LEGO.com/service)

47x
6143431

28x
6439726

6x
6186012

2x
4570877

20x
6228839

2x
6074892

11x
6253418

6x
6353237

1x
6326099

1x
6245307

3x
6514007

7x
6514224

8x
6510178

5x
6550815

1x
6240515

12x
6087084

1x
6523318

2x
6055172

2x
6480380

24x
6315608

64x
6532422

2x
6411591

12x
6532421

12x
4504375

4x
4521915

2x
6532423

16x
6532420

9x
6400754

2x
4245571

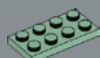

2x
6249817

2x
6209681

6x
6186673

2x
6284586

4x
4211183

4x
6215659

2x
6173143

1x
6348057

1x
6451002

1x
6306775

1x
4211159

1x
6488490

8x
4211180

1x
6492629

1x
6173132

1x
6468829

6x
4211210

8x
6425510

4x
4211200

1x
6116613

2x
4211201

3x
6170468

2x
6372430

2x
4211193

4x
6096701

1x
4529241

1x
6510189

7x
4521921

1x
6183782

8x
4211414

2x
4211387

8x
4211413

2x
4211397

1x
6070564

2x
4211361

2x
4211396

6x
6015347

1x
4612621

2x
4211452

6x
4211425

2x
4211404

2x
4211407

6x
6519672

6x
6096990

1x
6465604

2x
6395635

1x
4504378

1x
4210848

2x
6388118

2x
4211088

3x
4211094

8x
4624186

4x
4210897

2x
4509911

2x
6199511

2x
6187438

6x
4210997

8x
6272145

2x
6313601

4x
6365746

8x
6187006

24x
6102998

22x
6218359

1x
6472547

3x
6475523



YOU COULD WIN



YOU COULD WIN

Your feedback will help shape the future development of this product series.

Visit:

DU KÖNNTEST GEWINNEN

Dein Feedback trägt zur Weiterentwicklung dieser Produktreihe bei.

Geh auf:

VOUS POURRIEZ GAGNER

Vos commentaires nous aideront à concevoir les futurs produits de cette gamme.

Visitez :

POTRESTI VINCERE TU

La tua opinione ci aiuterà a migliorare la creazione futura di questa linea di prodotti.

Visita:

PUEDES GANAR

Tu opinión contribuirá al futuro de esta serie de productos.

Visita:

轻松获奖

您的反馈将有助于我们在今后改进本产品系列。

请访问:

[LEGO.com/productfeedback](https://www.lego.com/productfeedback)

You also have the chance to win a LEGO® set.

Terms and conditions apply.*

Außerdem hast du die Chance, ein LEGO® Set zu gewinnen.

Es gelten die Teilnahmebedingungen.*

Vous pourriez également gagner un ensemble LEGO®.

Des conditions s'appliquent.*

Hai anche la possibilità di vincere un set LEGO®.

Termini e condizioni sono applicabili.*

También tienes la oportunidad de ganar un set LEGO®.

Aplican términos y condiciones.*

您还有机会赢取乐高®套装。

条款和条件适用。*

*[LEGO.com/productfeedback-terms](https://www.lego.com/productfeedback-terms)



LEGO and the LEGO logo are trademarks of the LEGO Group. ©2025 The LEGO Group.

6553150