

# Hardware Maintenance Manual

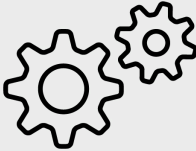

ThinkPad T14s Gen 7 and ThinkPad T14s 2-in-1 Gen 2

**First Edition (April 2026)**

**© Copyright Lenovo 2026.**

LIMITED AND RESTRICTED RIGHTS NOTICE: If data or software is delivered pursuant to a General Services Administration "GSA" contract, use, reproduction, or disclosure is subject to restrictions set forth in Contract No. GS-35F-05925.

---

# Contents

<b>About this manual</b> . . . . .	<b>iii</b>
------------------------------------	------------

<b>Chapter 1. Meet your computer</b> . . . . .	<b>1</b>
Front view . . . . .	1
Left-side view . . . . .	6
Right-side view . . . . .	9
Bottom view . . . . .	10

<b>Chapter 2. Safety requirements for hardware maintenance</b> . . . . .	<b>12</b>
General safety requirements . . . . .	12
Electrical safety requirements . . . . .	12
Safety inspection guide . . . . .	14
Handle devices that are sensitive to electrostatic discharge . . . . .	14
Important danger warning in multiple languages . . . . .	15

<b>Chapter 3. Diagnostics and troubleshooting</b> . . . . .	<b>29</b>
Overall procedures . . . . .	29
Diagnose the power system . . . . .	30
Verify the ac power adapter and the built-in battery . . . . .	30
Diagnose the ac power adapter . . . . .	30
Diagnose the built-in battery and operational charging . . . . .	31
Diagnostics applications . . . . .	31
Hardware scan in Vantage . . . . .	31
UEFI diagnostics application . . . . .	32
Advanced diagnostics application (Windows version) . . . . .	32
Advanced diagnostics application (bootable versions for Linux/UEFI) . . . . .	33
Lenovo Memory Self Repair . . . . .	33
Undetermined problems . . . . .	34
Symptom-to-CRU/FRU index . . . . .	34
Error codes . . . . .	35
Error messages . . . . .	36
Battery-charge LED indicator status and diagnosis . . . . .	37
No-beep symptoms . . . . .	39
Display-related symptoms . . . . .	40
Intermittent problems . . . . .	41
Call Lenovo . . . . .	41
Before you contact Lenovo . . . . .	41
Find your service QR code and serial number . . . . .	42
Lenovo Customer Support Center . . . . .	42
Nonwarranted items and activities . . . . .	42

<b>Chapter 4. Reference information for hardware replacement</b> . . . . .	<b>44</b>
Parts . . . . .	44
Part type definition . . . . .	44
Look up a part . . . . .	45
Exploded view and part list . . . . .	45
Screws . . . . .	48
Screw list . . . . .	49
Screw notices . . . . .	49
Service tools . . . . .	50
Connectors and cables for replacement . . . . .	53
Antenna locations . . . . .	55
Replacement videos . . . . .	58

<b>Chapter 5. Hardware replacement</b> . . . . .	<b>59</b>
Before hardware replacement . . . . .	59
General prerequisites and guidelines . . . . .	59
Prerequisites for opening the base cover . . . . .	60
Disable Fast Startup and the built-in battery . . . . .	60
Remove the nano-SIM card and nano-SIM-card tray (for selected models) . . . . .	60
Base cover assembly . . . . .	61
Apply labels to the base cover assembly . . . . .	62
M.2 solid-state drive and M.2 solid-state drive bracket . . . . .	63
Type 1 . . . . .	63
Type 2 . . . . .	64
Wireless WAN module and wireless WAN module bracket (for selected models) . . . . .	65
5G models . . . . .	65
4G models . . . . .	66
Dummy wireless WAN module and wireless WAN module bracket . . . . .	66
Replaceable USB-C module and replaceable USB-C module bracket . . . . .	67
Built-in battery . . . . .	69
Thermal fan assembly . . . . .	71
Speaker assembly and wireless WAN MIMO antenna kits . . . . .	74
Wireless WAN antenna assembly (for selected models) . . . . .	74
Lenovo Integrated Pen (for selected 2-in-1 models) . . . . .	76
Dummy Pen (for selected 2-in-1 models) . . . . .	76
Pen charge cable(for selected 2-in-1 models) . . . . .	77
NFC module (for selected models) . . . . .	78
Smart card reader and audio smart card sponge (for selected models) . . . . .	78

Dummy smart card (for selected models) . . . . .	80
Smart card reader-Trackpad-NFC cable (for selected models) . . . . .	81
Display unit (ThinkPad T14s Gen 7) . . . . .	82
Install new color profiles for display panel with the factory color calibration feature . . . . .	85
Display unit (ThinkPad T14s 2-in-1 Gen 2) . . . . .	85
Sensor calibration . . . . .	87
Install new color profiles for display panel with the factory color calibration feature . . . . .	88
Sub-USB board bracket . . . . .	88
Fingerprint reader cable . . . . .	89
USB I/O cable and wireless WAN I/O cable . . . . .	90
Sub-USB board . . . . .	91
Camera cable guide . . . . .	92
System board . . . . .	93
Input the product information. . . . .	97
Power button with or without fingerprint reader and fingerprint reader bracket . . . . .	99
Trackpad and Trackpad waterproof mylar . . . . .	100
Keyboard assembly . . . . .	103
LCD FRUS and CRUS (ThinkPad T14s Gen 7) . . . . .	104
LCD bezel, LCD panel, LCD cable and elastic adhesive tapes . . . . .	104
Camera shutter . . . . .	108
Camera-and-microphone module and cable (for selected models) . . . . .	109
Wireless LAN antenna assembly . . . . .	110
Strip cover and LCD hinges . . . . .	112
LCD cover assembly . . . . .	113
LCD FRUS and CRUS (ThinkPad T14s 2-in-1 Gen 2) . . . . .	113
LCD strip cover . . . . .	113
LCD hinges and hinges cover . . . . .	114
LCD cable, LCD panel and elastic adhesive tapes . . . . .	115
Camera-and-microphone cable and module (for selected models) . . . . .	119

WLAN antenna assembly . . . . .	120
LCD cover assembly for 2-in-1 models . . . . .	121

## **Chapter 6. Supplemental instructions . . . . .122**

Use the keyboard shortcuts . . . . .	122
Install, upgrade, and recover operating system . . . . .	123
Install a Windows operating system . . . . .	123
Windows operating system installation error . . . . .	124
Upgrade my Windows operating system . . . . .	125
Windows operating system upgrading error . . . . .	126
Recover my Windows operating system . . . . .	126
Windows operating system recovery error. . . . .	127
Passwords. . . . .	127
UEFI BIOS passwords . . . . .	127
Windows passwords . . . . .	130
Retrieve my BitLocker recovery key in Windows . . . . .	130
Power management . . . . .	131
Sleep mode . . . . .	131
Hibernation mode . . . . .	131

## **Appendix A. Notice for USB connector name update . . . . .133**

## **Appendix B. Self-help resource . . . . .134**

## **Appendix C. Important notice for Quebec consumers . . . . .137**

## **Appendix D. Notices and trademarks. . . . .138**

## **Appendix E. Abbreviation table . . . . .140**

---

## About this manual

This manual contains hardware maintenance instructions for the product listed in the following table. In this manual, you will read safety requirements for hardware maintenance, diagnostics and troubleshooting, hardware replacement instructions, and other reference information. Use the manual along with the diagnostics applications and service tools to troubleshoot problems effectively.

Product name	Machine type (MT)
ThinkPad T14s Gen 7	21YU,21YV,21YW,21YX
ThinkPad T14s 2-in-1 Gen 2	21YY,22A0

ThinkPad T14s Gen 7 might be shipped with different microprocessors, namely Intel® and Advanced Micro Devices (AMD). Hereby Intel models and AMD models are used to distinguish computer models with different microprocessors.

### Important:

- Hardware configurations and software programs vary by machine type. Some statements or illustrations in this manual might be slightly different from your computer.
- It is recommended that the computer be repaired by trained service technicians.
- For customers electing to service the computer on their own, it is still recommended to speak to our Customer Support Center so that you can be directed to the correct documentation and repair information. See “Call Lenovo” on page 41. Depending on the complexity of the repair, it may be recommended to have a Lenovo-authorized service provider repair your computer.
- Before servicing a computer, please follow all instructions carefully and be sure to read all the information under Chapter 2 “Safety requirements for hardware maintenance” on page 12 and “Before hardware replacement” on page 59.

# Chapter 1. Meet your computer

## Front view

Have a quick glance at the front view of your computer.

### ThinkPad T14s Gen 7



#### **Microphone\***

Turn on the microphone to capture sound and voice when it is used with an application program capable of handling audio.

#### **Webcam privacy shutter\***

Slide the webcam privacy shutter left to cover the camera lens when not in use or in public network to prevent unauthorized access and enhance privacy.



### **Infrared camera\* / Camera\***

Use the infrared camera to take pictures, shoot videos or scan barcodes in Camera or other application programs that provide features such as photographing, video capturing, and video conferences.



### **Touch screen\***

Interact with your computer through intuitive controls like tapping, swiping, pinching, and zooming. For more information about the frequently used touch gestures.



### **Power button with fingerprint reader\***

The power button on your computer performs following functions depending on how you press it:

- **Power on:** Press the power button to turn on the computer and log in with your fingerprint. For more information about fingerprints enrollment.
- **Enter sleep mode:** Press the power button for one second to enter sleep mode.
- **Force a shutdown:** If the computer becomes unresponsive, press and hold the power button for at least 10 seconds to force a shutdown.
- **Hard reset:** If a forced shutdown does not work, or if you encounter issues such as the battery not charging, abnormal fan behavior, keyboard malfunction, or power management errors, disconnect the ac adapter then press and hold the power button for at least 14 seconds to perform a hard reset.

**Note:** Performing a forced shutdown or hard reset might cause unsaved data loss or file corruption. Perform these operations with caution.



### **Speaker**

The built-in dual stereo speakers deliver clear, balanced audio for everyday tasks from streaming movies to video calls.



### **NFC (near field communication) label\***

Simply tap and connect your computer and another NFC-enabled device over a few centimeters or inches. To set up an NFC connection.



### **Trackpad**

Experience all the pointing, clicking, and scrolling functions of a traditional mouse through Trackpad. For more information about the Trackpad.



### **TrackPoint Three Buttons**

The TrackPoint left button and TrackPoint right button correspond to the left and right buttons of a traditional mouse. Press and hold the TrackPoint center button while using your finger to applying pressure to the pointing stick in the vertical or horizontal direction. Then, you can scroll through the document, Web site, or apps. For more information about the TrackPoint pointing device.

## **TrackPoint pointing stick**

Use your finger to apply pressure to the pointing-stick nonslip cap in any direction parallel to the keyboard. The pointer on the screen moves accordingly. To know how it works with TrackPoint Three Buttons as a traditional mouse.

\* for selected models

### **ThinkPad T14s 2-in-1 Gen 2**



## **Microphone**

Turn on the microphone to capture sound and voice when it is used with an application program capable of handling audio.

## **Infrared camera / Camera**

Use the infrared camera to take pictures, shot videos or scan barcodes in Camera or other application programs that provide features such as photographing, video capturing, and video conferences.



### **Webcam privacy shutter**

Slide the webcam privacy shutter left to cover the camera lens when not in use or in public network to prevent unauthorized access and enhance privacy.



### **Touch screen**

Interact with your computer through intuitive controls like tapping, swiping, pinching, and zooming. For more information about the frequently used touch gestures.



### **Power button with fingerprint reader**

The power button on your computer performs following functions depending on how you press it:

- **Power on:** Press the power button to turn on the computer and log in with your fingerprint. For more information about fingerprints enrollment.
- **Enter sleep mode:** Press the power button for one second to enter sleep mode.
- **Force a shutdown:** If the computer becomes unresponsive, press and hold the power button for at least 10 seconds to force a shutdown.
- **Hard reset:** If a forced shutdown does not work, or if you encounter issues such as the battery not charging, abnormal fan behavior, keyboard malfunction, or power management errors, disconnect the ac adapter then press and hold the power button for at least 14 seconds to perform a hard reset.

**Note:** Performing a forced shutdown or hard reset might cause unsaved data loss or file corruption. Perform these operations with caution.



### **Speaker**

The built-in dual stereo speakers deliver clear, balanced audio for everyday tasks from streaming movies to video calls.



### **NFC (near field communication) label\***

Simply tap and connect your computer and another NFC-enabled device over a few centimeters or inches. To set up an NFC connection.



### **Trackpad**

Experience all the pointing, clicking, and scrolling functions of a traditional mouse through Trackpad. For more information about the Trackpad.



### **TrackPoint Three Buttons**

The TrackPoint left button and TrackPoint right button correspond to the left and right buttons of a traditional mouse. Press and hold the TrackPoint center button while using your finger to applying pressure to the pointing stick in the vertical or horizontal direction. Then, you can scroll through the document, Web site, or apps. For more information about the TrackPoint pointing device.



## TrackPoint pointing stick

Use your finger to apply pressure to the pointing-stick nonslip cap in any direction parallel to the keyboard. The pointer on the screen moves accordingly. To know how it works with TrackPoint Three Buttons as a traditional mouse.

\* for selected models

### Important information

Your computer contains magnets. Keep a safe distance away from devices and objects that might be affected by magnets, such as credit cards.

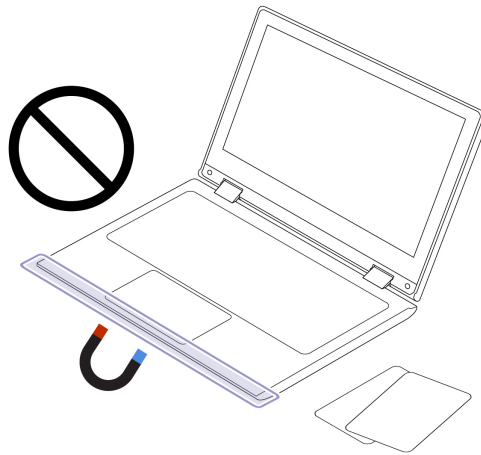

---

## Left-side view

Have a quick glance at the left side of your computer.

### ThinkPad T14s Gen 7 Intel



### ThinkPad T14s Gen 7 AMD



## ThinkPad T14s 2-in-1 Gen 2



### **HDMI** HDMI™ connector

Connect your computer to external displays, projectors, or HDTVs through the HDMI connector. For more information about the external display connection.

### **USB-C® power connector (Thunderbolt™ 4)**

Experience ultra-high-speed data transfer, power delivery, or multi-device support through USB-C power connector. For more information about USB specifications.

### **USB-C® power connector (5Gbps)**

Experience high-speed data transfer, power delivery, or multi-device support through USB-C power connector.

### **Audio connector**

Connect wired headphones, headsets, external speakers, or microphones for audio playback and recording through the audio connector.

### **Lenovo Integrated Pen\***

The garaged rechargeable electronic pen enables a more precise and easier way of writing and sketching.

### **Statement on USB transfer rate**

Depending on many factors such as the processing capability of the host and peripheral devices, file attributes, and other factors related to system configuration and operating environments, the actual transfer rate using the various USB connectors on this device will vary and will be slower than the data rate listed in the connector name or below for each corresponding device.

<b>USB device</b>	<b>Data rate (Gbps)</b>
Thunderbolt 3	40
Thunderbolt 4	40

---

## Right-side view

Have a quick glance at ports on both sides of your computer.



### Smart-card slot\*

Insert Smart-card to transfer data. To install or remove a Smart-card.



### Nano-SIM-card tray\*

Insert Nano-SIM-card to connect a 4G or 5G cellular data network. To install or remove a Nano-SIM-card.



### USB-A connector (USB 5Gbps, Always On USB)

Charge smart phones, tablets, or other USB devices even when your computer is turned off, in sleep mode, or hibernating through the USB-A connector. For more information about USB specifications.



### USB-C power connector (Thunderbolt 4)

Experience ultra high-speed data transfer, power delivery, or multi-device support through the USB-C connector. For more information about USB specifications.



### Security slot

Lock your computer to a desk, table, or other fixtures through a compatible security cable lock. For more information about the security slot.

### Statement on USB transfer rate

Depending on many factors such as the processing capability of the host and peripheral devices, file attributes, and other factors related to system configuration and operating environments, the actual transfer rate using the various USB connectors on this device will vary and will be slower than the data rate listed in the connector name or below for each corresponding device.

USB device	Data rate (Gbps)
Thunderbolt 3	40
Thunderbolt 4	40

### Bottom view

Have a quick glance at the bottom part of your computer.

#### ThinkPad T14s Gen 7

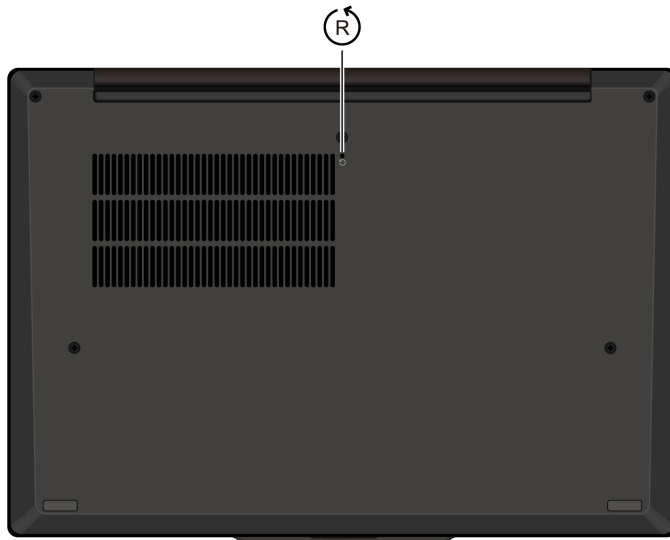

#### ThinkPad T14s 2-in-1 Gen 2

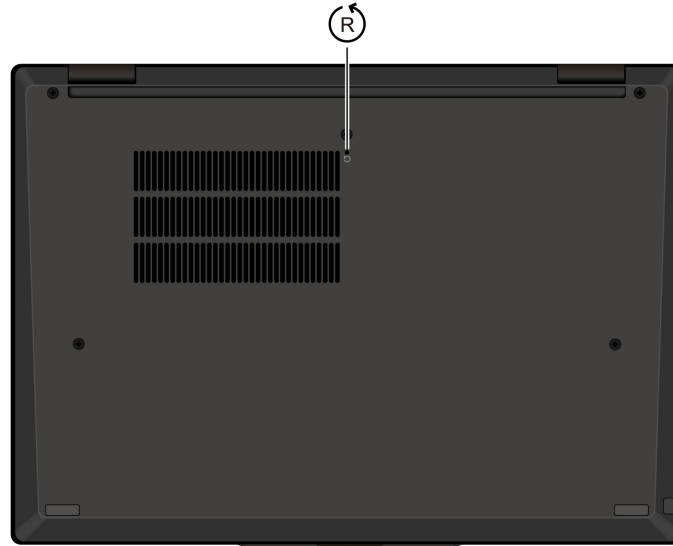

### **Emergency-reset hole**

Emergency-reset hole can help you to recover computer when the computer stops responding and you cannot turn it off by pressing the power button. Do the following to perform a hard reset:

- Step 1. Disconnect your computer from ac power.
- Step 2. Insert a straightened paper clip into the hole to cut off power supply temporarily.
- Step 3. Connect your computer to ac power and then turn on your computer.

If your computer is still no response, you can call Lenovo Customer Support Center to get further help.

### **Cool and Quiet on Lap**

When your computer is on your lap in Best Performance mode, it detects lap-specific unsteady movement and temporarily lowers performance to reduce heat and discomfort. Once stable, full performance is automatically restored.

#### **CAUTION:**

**When the computer is operating, it should be placed on a hard and flat surface with its bottom area not in contact with user's bare skin. Under normal operating conditions, the temperature of the bottom surface will remain within an acceptable range as defined in IEC 62368-1, but such temperatures can still be high enough to cause discomfort or harm to the user if directly touched for over 10 seconds at a time. As such, it is recommended that users avoid prolonged direct contact with the bottom of the computer.**

**Note:** Some Lenovo computers include a display that can be rotated 360 degrees. When those products are used as a tablet computer, the temperatures of all the accessible parts are within an acceptable range as defined in IEC 62368-1.

---

## Chapter 2. Safety requirements for hardware maintenance

This chapter presents the following safety requirements that you need to be familiar with before you service a notebook computer.

---

### General safety requirements

Meet the following requirements on environment, personnel and outfit, and operation to ensure general safety:

#### Environment requirements

Observe good housekeeping in the area of the machine during and after maintenance.

#### Personnel and outfit requirements

- Do not wear loose clothing that can be trapped in the moving parts of a machine. Ensure that your sleeves are fastened or rolled up above your elbows. If your hair is long, fasten it.
- Insert the ends of your necktie or scarf inside clothing or fasten it with a nonconductive clip, about 8 centimeters (3 inches) from the end.
- Do not wear jewelry, chains, metal-frame eyeglasses, or metal fasteners for your clothing, because metal objects are good electrical conductors.
- Wear safety glasses when you are hammering, drilling, soldering, cutting wire, attaching springs, using solvents, or working in any other conditions that might be hazardous to your eyes.

#### Operation requirements

- Before you start the machine, ensure that no one is in a hazardous position.
- Do not perform any action that causes personal injury, or that makes the equipment unsafe.
- Keep your tool case away from walk areas so that other people will not trip over it.
- When lifting any heavy object:
  1. Ensure that you can stand safely without slipping.
  2. Distribute the weight of the object equally between your feet.
  3. Use a slow lifting force. Never move suddenly or twist when you attempt to lift.
  4. Lift by standing or by pushing up with your leg muscles; this action removes the strain from the muscles in your back. Do not attempt to lift any object that weighs more than 16 kg (35 lb) or that you think is too heavy for you.
- Place removed covers and other parts in a safe place, away from all personnel, while you are servicing the machine.
- After service, reinstall all safety shields, guards, labels, and ground wires. Replace any safety device that is worn or defective. Reinstall all covers correctly.
- Fan louvers on the machine help to prevent overheating of internal components. Do not obstruct fan louvers or cover them with labels or stickers.

---

### Electrical safety requirements

To ensure electrical safety, meet the following requirements on environment, outfit, and operation when working on the computer:

## Environment requirements

- Find the room emergency power-off (EPO) switch, disconnecting switch, or electrical outlet. If an electrical accident occurs, you can then operate the switch or unplug the power cord quickly.
- Do not work alone under hazardous conditions or near equipment that has hazardous voltages.
- Always look carefully for possible hazards in your work area. Examples of these hazards are moist floors, nongrounded power extension cables, power surges, and missing safety grounds.

## Outfit requirements

- Do not use worn or broken tools and testers.
- Use only approved tools and test equipment. Some hand tools have handles covered with a soft material that does not insulate you when working with live electrical currents.
- Regularly inspect and maintain your electrical hand tools for safe operational condition.
- Many customers have, near their equipment, rubber floor mats that contain small conductive fibers to decrease electrostatic discharges (ESD). Do not use this type of mat to protect yourself from electrical shock.

## Operation requirements

- Disconnect all power before:
  - Performing a mechanical inspection
  - Working near power supplies
  - Removing or installing main units
- Do not service the following parts with the power on:
  - Power supply units
  - Fans
  - Units similar to those listed above

This practice ensures correct grounding of the units.

- Electrical grounding of the computer is required for operator safety and correct system function. Proper grounding of the electrical outlet can be verified by a certified electrician.
- Observe the special safety precautions when you work with very high voltages. Instructions for these precautions are in the safety sections of maintenance information. Use extreme care when measuring high voltages.
- Before you start to work on the machine, unplug the power cord. If you cannot unplug it, power off the wall box that supplies power to the machine and lock the wall box in the off position.
- Never assume that power has been disconnected from a circuit. First, check that it has been powered off.
- Do not touch live electrical circuits with the reflective surface of a plastic dental mirror. The surface is conductive; such touching can cause personal injury and machine damage.
- If you need to work on a machine that has exposed electrical circuits, observe the following precautions:
  - Ensure that another person, familiar with the power-off controls, is near you. That person must be there to switch off the power, if necessary.
  - Use only one hand when working with powered-on electrical equipment; keep the other hand in your pocket or behind your back.

### **CAUTION:**

**An electrical shock can occur only when there is a complete circuit. By observing the above rule, you may prevent a current from passing through your body.**

- When using testers, set the controls correctly and use the approved probe leads and accessories for that tester.
- Stand on suitable rubber mats (obtained locally, if necessary) to insulate you from grounds such as metal floor strips and machine frames.

- If an electrical accident occurs:
  - Use caution; do not become a victim yourself.
  - Switch off power.
  - Send another person to get medical aid.

---

## Safety inspection guide

The purpose of this inspection guide is to assist you in identifying potentially unsafe conditions. As each machine was designed and built, required safety items were installed to protect users and service technicians from injury. This guide addresses only those items. You should use good judgment to identify potential safety hazards due to attachment of non-ThinkPad / non-Lenovo features or options not covered by this inspection guide.

If any unsafe conditions are present, you must determine how serious the apparent hazard could be and whether you can continue without first correcting the problem. Consider these conditions and the safety hazards they present:

- Electrical hazards, especially primary power (primary voltage on the frame can cause serious or fatal electrical shock)
- Explosive hazards, such as a damaged CRT face or a bulging capacitor
- Mechanical hazards, such as loose or missing hardware

To determine whether there are any potentially unsafe conditions, use the following checklist at the beginning of every service task. Begin the checks with the power off and the power cord disconnected:

- Before removing the cover:
  1. Check exterior covers for damage (loose, broken, or sharp edges).
  2. Turn off the computer. Disconnect the power cord. Check the power cord for:
    - a. A third-wire ground connector in good condition. Use a meter to measure third-wire ground continuity for 0.1 ohm or less between the external ground pin and the frame ground.
    - b. The power cord should be the authorized type specified for your computer. Go to: <https://support.lenovo.com/partslookup>.
    - c. Insulation must not be frayed or worn.
  3. Check for cracked or bulging batteries.
- After removing the cover:
  1. Check for any obvious non-ThinkPad / non-Lenovo alterations. Use good judgment as to the safety of any non-ThinkPad / non-Lenovo alterations.
  2. Check inside the unit for any obvious unsafe conditions, such as metal filings, contamination, water or other liquids, or signs of fire or smoke damage.
  3. Check for worn, frayed, or pinched cables.
  4. Check that the power-supply cover fasteners (screws or rivets) have not been removed or tampered with.

---

## Handle devices that are sensitive to electrostatic discharge

Any computer part containing transistors or integrated circuits (ICs) should be considered sensitive to electrostatic discharge (ESD). ESD damage can occur when there is a difference in charge between objects. Protect against ESD damage by equalizing the charge so that the machine, the part, the work mat, and the person handling the part are all at the same charge.

### Notes:

1. Use product-specific ESD procedures when they exceed the requirements noted here.
2. Ensure that the ESD protective devices you use have been certified (ISO 9000) as fully effective.

When handling ESD-sensitive parts:

- Keep the parts in protective packages until they are inserted into the product.
- Avoid contact with other people.
- Wear a grounded wrist strap against your skin to eliminate static on your body.
- Prevent the part from touching your clothing. Most clothing is insulative and retains a charge even when you are wearing a wrist strap.
- Use a grounded work mat to provide a static-free work surface. The mat is especially useful when handling ESD-sensitive devices.
- Select a grounding system, such as those listed below, to provide protection that meets the specific service requirement.

**Note:** The use of a grounding system to guard against ESD damage is desirable but not necessary.

- Attach the ESD ground clip to any frame ground, ground braid, or green-wire ground.
- When working on a double-insulated or battery-operated system, use an ESD common ground or reference point. You can use coax or connector-outside shells on these systems.
- Use the round ground prong of the ac plug on ac-operated computers.

---

## Important danger warning in multiple languages

The safety notices in this section are provided in the following languages:

- English
- Arabic
- Brazilian Portuguese
- French
- German
- Hebrew
- Japanese
- Korean
- Spanish
- Traditional Chinese

### English

**Note:**



### DANGER

**Before the computer is powered on after FRU replacement, make sure that all screws, springs, and other small parts are in place and are not left loose inside the computer. Verify this by shaking the computer and listening for rattling sounds. Metallic parts or metal flakes can cause electrical short circuits.**



### DANGER

Some standby batteries contain a small amount of nickel and cadmium. Do not disassemble a standby battery, recharge it, throw it into fire or water, or short-circuit it. Dispose of the battery as required by local ordinances or regulations. Use only the battery in the appropriate parts listing. Use of an incorrect battery can result in ignition or explosion of the battery.



#### **DANGER**

The battery pack contains small amounts of nickel. Do not disassemble it, throw it into fire or water, or short-circuit it. Dispose of the battery pack as required by local ordinances or regulations. Use only the battery in the appropriate parts listing when replacing the battery pack. Use of an incorrect battery can result in ignition or explosion of the battery.



#### **DANGER**

The lithium battery can cause a fire, an explosion, or a severe burn. Do not recharge it, remove its polarized connector, disassemble it, heat it above 100°C (212°F), incinerate it, or expose its cell contents to water. Dispose of the battery as required by local ordinances or regulations. Use only the battery in the appropriate parts listing. Use of an incorrect battery can result in ignition or explosion of the battery.



#### **DANGER**

If the LCD breaks and the fluid from inside the LCD gets into your eyes or on your hands, immediately wash the affected areas with water for at least 15 minutes. Seek medical care if any symptoms from the fluid are present after washing.



#### **DANGER**

To avoid shock, do not remove the plastic cover that protects the lower part of the inverter card.



#### **DANGER**

Though the main batteries have low voltage, a short-circuited or grounded battery can produce enough current to burn personnel or combustible materials.



#### **DANGER**

Unless hot swap is allowed for the FRU being replaced, do as follows before removing it: power off the computer, unplug all power cords from electrical outlets, remove the battery pack, and disconnect any interconnecting cables.



قبل اعادة تشغيل الحاسب بعد الانتهاء من استبدال FRU، تأكد من أنه قد تم اعادة كل من المسامير و السوست وكل الأجزاء الصغيرة الأخرى في أماكنهم ولم يتم فتحهم داخل الحاسب. ويمكن التحقق من ذلك عن طريق هز الحاسب والاستماع لأي صوت صاخب يصدر منه. قد تؤدي الأجزاء أو الرقائق المعدنية الى حدوث دائرة قصر.



تحتوي بعض البطاريات الاحتياطية على كمية صغيرة من مادتي النيكل والكادميوم. لا تقم بفك أو اعادة شحن البطارية الاحتياطية ولا تقم أيضا بالقاءها في النار أو الماء ولا تتسبب في احداث دائرة قصر بها. قم بالتخلص من البطارية كما هو موضح في القوانين المحلية. استخدم نوع البطارية المحدد والذي يوصى باستخدامه. حيث أنه قد يؤدي استخدام نوع بطارية غير صحيح الى اشتعالها أو انفجارها.



تحتوي حزمة البطارية على كمية صغيرة من مادة النيكل. لا تقم بفكها أو القاءها في النار أو الماء ولا تتسبب في احداث دائرة قصر بها. تخلص من حزمة البطارية وفقا لما هو موضح في القوانين المحلية. قم، عند استبدال حزمة البطارية، باستخدام الأنواع المحددة فقط والتي يوصى باستخدامها. حيث أنه قد يؤدي استخدام نوع بطارية غير صحيح الى اشتعالها أو انفجارها.



قد تتسبب بطارية الليثيوم في حدوث حريق أو انفجار أو حدوث حروق شديدة. لا تقم باعادة شحن البطارية أو ازالة موصل الاستقطاب الخاص بها ولا تحاول أيضا فكها أو تسخينها لأكثر من ١٠٠ درجة مئوية (٢١٢١ فهرنهايت) أو حرقها أو تعريض محتويات الخانة الخاصة بها للماء. قم بالتخلص من البطارية وفقا لما هو موضح في القوانين المحلية. استخدم نوع البطارية المحدد والذي يوصى باستخدامه. حيث أنه قد يؤدي استخدام نوع بطارية غير صحيح الى اشتعالها أو انفجارها.



إذا ما انكسرت شاشة LCD ولامس السائل الداخلي عينيك أو يديك، قم في الحال بغسلهما بالماء لمدة لا تقل عن ١٥ دقيقة. إذا ما وجدت أي أعراض بعد الغسل اطلب عندئذ المساعدة الطبية.



لتجنب التعرض لأي صدمات، لا تَقم بإزالة الغطاء البلاستيكي الذي يحمي الجزء الأسفل من بطاقة العاكس.



على الرغم من أن البطاريات الرئيسية يكون لها جهد منخفض، إلا أنه قد تقوم البطاريات التي حدث قصور بها أو التي تم توصيلها أرضيا بإصدار تيار يكفي لحدوث حروق للأفراد أو تعرض المواد القابلة للاشتعال للحريق.



ما لم يتم السماح بالتبديل الفوري لأي FRU الجاري استبداله بدون ضرورة اغلاق النظام، قم بتنفيذ ما يلي قبل ازالته. قم بإيقاف تشغيل الحاسب ونزع كل أسلاك الطاقة من المخارج الكهربائية وقم أيضا بإزالة حزمة البطارية ثم قم بفصل أي كابلات متصلة.

### Brazilian Portuguese



#### PERIGO

Antes de ligar o computador após a substituição da FRU, certifique-se de que todos os parafusos, molas e outras peças pequenas estejam no lugar e não estejam soltos dentro do computador. Verifique isso sacudindo o computador e procurando ouvir sons de peças soltas. Peças metálicas ou lascas de metal podem causar curto-circuito.



#### PERIGO

Algumas baterias reserva contêm uma pequena quantidade de níquel e cádmio. Não desmonte uma bateria reserva, recarregue-a, jogue-a no fogo ou na água, ou deixe-a entrar em curto-circuito. Descarte a bateria conforme requerido pelas leis ou regulamentos locais. Use somente a bateria nas partes listadas apropriadas. O uso de uma bateria incorreta pode resultar em combustão ou explosão da bateria.



#### PERIGO

O pacote da bateria contém uma pequena quantidade de níquel. Não o desmonte, jogue-o no fogo ou na água, ou deixe-o entrar em curto-circuito. Descarte o pacote da bateria conforme requerido pelas leis ou regulamentos locais. Use somente a bateria nas partes listadas apropriadas ao substituir o pacote da bateria. O uso de uma bateria incorreta pode resultar em combustão ou explosão da bateria.



#### PERIGO

A bateria de lítio pode causar incêndio, explosão ou graves queimaduras. Não a recarregue, remova seu conector polarizado, desmonte-a, aqueça-a acima de 100°C (212°F), incinere-a, ou exponha o conteúdo de sua célula à água. Descarte a bateria conforme requerido pelas leis ou regulamentos locais. Use somente a bateria nas partes listadas apropriadas. O uso de uma bateria incorreta pode resultar em combustão ou explosão da bateria.



#### PERIGO

Se o LCD quebrar e o fluido de dentro dele entrar em contato com seus olhos ou com suas mãos, lave as áreas afetadas imediatamente com água durante pelo menos 15 minutos. Procure cuidados médicos se algum sintoma causado pelo fluido surgir após a lavagem.



#### PERIGO

Para evitar choque elétrico, não remova a capa plástica que protege a parte inferior da placa inversora.



#### PERIGO

Embora as principais baterias possuam baixa voltagem, uma bateria em curto-circuito ou aterrada pode produzir corrente o bastante para queimar materiais de pessoal ou inflamáveis.



#### PERIGO

A menos que uma hot swap seja permitida para a FRU que está sendo substituída, faça o seguinte antes de removê-la: desligue o computador, desconecte todos os cabos de energia das tomadas, remova o pacote de baterias e desconecte quaisquer cabos de interconexão.

French



#### DANGER

Avant de remettre l'ordinateur sous tension après remplacement d'une unité en clientèle, vérifiez que tous les ressorts, vis et autres pièces sont bien en place et bien fixées. Pour ce faire, secouez l'unité et assurez-vous qu'aucun bruit suspect ne se produit. Des pièces métalliques ou des copeaux de métal pourraient causer un court-circuit.



#### DANGER

Certaines batteries de secours contiennent du nickel et du cadmium. Ne les démontez pas, ne les rechargez pas, ne les exposez ni au feu ni à l'eau. Ne les mettez pas en court-circuit. Pour les mettre au rebut, conformez-vous à la réglementation en vigueur. Lorsque vous remplacez la pile de sauvegarde ou celle de l'horloge temps réel, veillez à n'utiliser que les modèles cités dans la liste de pièces détachées adéquate. Une batterie ou une pile inappropriée risque de prendre feu ou d'exploser.



#### **DANGER**

La batterie contient du nickel. Ne la démontez pas, ne l'exposez ni au feu ni à l'eau. Ne la mettez pas en court-circuit. Pour la mettre au rebut, conformez-vous à la réglementation en vigueur. Lorsque vous remplacez la batterie, veillez à n'utiliser que les modèles cités dans la liste de pièces détachées adéquate. En effet, une batterie inappropriée risque de prendre feu ou d'exploser.



#### **DANGER**

La pile de sauvegarde contient du lithium. Elle présente des risques d'incendie, d'explosion ou de brûlures graves. Ne la rechargez pas, ne retirez pas son connecteur polarisé et ne la démontez pas. Ne l'exposez pas à une température supérieure à 100°C, ne la faites pas brûler et n'en exposez pas le contenu à l'eau. Mettez la pile au rebut conformément à la réglementation en vigueur. Une pile inappropriée risque de prendre feu ou d'exploser.



#### **DANGER**

Si le panneau d'affichage à cristaux liquides se brise et que vous recevez dans les yeux ou sur les mains une partie du fluide, rincez-les abondamment pendant au moins quinze minutes. Consultez un médecin si des symptômes persistent après le lavage.



#### **DANGER**

Afin d'éviter tout risque de choc électrique, ne retirez pas le cache en plastique protégeant la partie inférieure de la carte d'alimentation.



#### **DANGER**

Bien que le voltage des batteries principales soit peu élevé, le court-circuit ou la mise à la masse d'une batterie peut produire suffisamment de courant pour brûler des matériaux combustibles ou causer des brûlures corporelles graves.



#### **DANGER**

Si le remplacement à chaud n'est pas autorisé pour l'unité remplaçable sur site que vous remplacez, procédez comme suit avant de retirer l'unité : mettez l'ordinateur hors tension, débranchez tous les cordons d'alimentation des prises de courant, retirez le bloc de batterie et déconnectez tous les câbles d'interconnexion.

German



#### VORSICHT

Bevor nach einem FRU-Austausch der Computer wieder angeschlossen wird, muß sichergestellt werden, daß keine Schrauben, Federn oder andere Kleinteile fehlen oder im Gehäuse vergessen wurden. Der Computer muß geschüttelt und auf Klappergeräusche geprüft werden. Metallteile oder-splitter können Kurzschlüsse erzeugen.



#### VORSICHT

Die Bereitschaftsbatterie, die sich unter dem Diskettenlaufwerk befindet, kann geringe Mengen Nickel und Cadmium enthalten. Sie darf nur durch die Verkaufsstelle oder den IBM Kundendienst ausgetauscht werden. Sie darf nicht zerlegt, wiederaufgeladen, kurzgeschlossen, oder Feuer oder Wasser ausgesetzt werden. Die Batterie kann schwere Verbrennungen oder Verätzungen verursachen. Bei der Entsorgung die örtlichen Bestimmungen für Sondermüll beachten. Beim Ersetzen der Bereitschafts-oder Systembatterie nur Batterien des Typs verwenden, der in der Ersatzteilliste aufgeführt ist. Der Einsatz falscher Batterien kann zu Entzündung oder Explosion führen.



#### VORSICHT

Akkus enthalten geringe Mengen von Nickel. Sie dürfen nicht zerlegt, wiederaufgeladen, kurzgeschlossen, oder Feuer oder Wasser ausgesetzt werden. Bei der Entsorgung die örtlichen Bestimmungen für Sondermüll beachten. Beim Ersetzen der Batterie nur Batterien des Typs verwenden, der in der Ersatzteilliste aufgeführt ist. Der Einsatz falscher Batterien kann zu Entzündung oder Explosion führen.



#### VORSICHT

Die Systembatterie ist eine Lithiumbatterie. Sie kann sich entzünden, explodieren oder schwere Verbrennungen hervorrufen. Batterien dieses Typs dürfen nicht aufgeladen, zerlegt, über 100°C erhitzt oder verbrannt werden. Auch darf ihr Inhalt nicht mit Wasser in Verbindung gebracht oder der zur richtigen Polung angebrachte Verbindungsstecker entfernt werden. Bei der Entsorgung die örtlichen Bestimmungen für Sondermüll beachten. Beim Ersetzen der Batterie nur Batterien des Typs verwenden, der in der Ersatzteilliste aufgeführt ist. Der Einsatz falscher Batterien kann zu Entzündung oder Explosion führen.



#### VORSICHT

Die Leuchtstoffröhre im LCD-Bildschirm enthält Quecksilber. Bei der Entsorgung die örtlichen Bestimmungen für Sondermüll beachten. Der LCD-Bildschirm besteht aus Glas und kann zerbrechen, wenn er unsachgemäß behandelt wird oder der Computer auf den Boden fällt. Wenn der Bildschirm beschädigt ist und die darin befindliche Flüssigkeit in Kontakt mit Haut und Augen gerät, sollten die betroffenen Stellen mindestens 15 Minuten mit Wasser abgespült und bei Beschwerden anschließend ein Arzt aufgesucht werden.



## VORSICHT

Aus Sicherheitsgründen die Kunststoffabdeckung, die den unteren Teil der Spannungswandlerplatine umgibt, nicht entfernen.



## VORSICHT

Obwohl Hauptbatterien eine niedrige Spannung haben, können sie doch bei Kurzschluß oder Erdung genug Strom abgeben, um brennbare Materialien zu entzünden oder Verletzungen bei Personen hervorzurufen.



## VORSICHT

Wenn ein Austausch der FRU bei laufendem Betrieb nicht erlaubt ist, gehen Sie beim Austausch der FRU wie folgt vor: Schalten Sie den Computer aus, ziehen Sie alle Netzkabel von den Netzsteckdosen ab, entfernen Sie den Akku und ziehen Sie alle miteinander verbundenen Kabel ab.

## Hebrew



## סכנה

לפני הפעלת המחשב לאחר החלפת FRU יש לוודא שכל הברגים, חקפיצים, וחלקים קטנים אחרים נמצאים במקומם ואינם חופשיים לזוז בתוך המחשב. כדי לוודא זאת, יש לטלטל את המחשב ולחקשיב לגילוי קולות שקשוק. חלקי או שבבי מתכת עלולים לגרום לקצרים חשמליים.



## סכנה

סוללות המתנה מסוימות מכילות כמות קטנה של ניקל וקדמיום. אין לפרק סוללת המתנה, לטעון אותה מחדש, להשליך אותה לאש או למים או לקצר אותה. יש לסלק את הסוללה כנדרש על ידי התקנות והחוקים המקומיים. יש להשתמש רק בסוללה המופיעה ברשימת החלקים המתאימה. שימוש בסוללה לא מתאימה עלול לגרום להצתה או התפוצצות של הסוללה.



## סכנה

מארז הסוללה מכיל כמות קטנה של ניקל וקדמיום. אין לפרק את מארז הסוללה, להשליך אותו לאש או למים או לקצר אותו. יש לסלק את מארז הסוללה כנדרש על ידי התקנות והחוקים המקומיים. יש להשתמש רק בסוללה המופיעה ברשימת החלקים המתאימה בזמן החלפת מארז הסוללה. שימוש בסוללה לא מתאימה עלול לגרום להצתה או התפוצצות של הסוללה.



## סכנה

סוללת הליתיום עלולה לגרום לשריפה, להתפוצצות או לכוויות קשות. אין לטעון אותה מחדש, לסלק את המחבר המקוטב שלה, לפרק אותה או לחמם אותה לטמפרטורה העולה על 100 מעלות צלזיוס. אין לשרוף את הסוללה ואין לחשוף את תוכן התא למים. יש לסלק את הסוללה כנדרש בתקנות ובחוקים המקומיים. יש להשתמש רק בסוללה המופיעה ברשימת החלקים המתאימים. שימוש בסוללה אחרת עלול לגרום לסכנת שריפה או התפוצצות.



סכנה

אם מסך הנביש חנוזלי (LCD) נשבר והנוזל מתוך המסך בא במגע עם עיניים או ידיים, שטפו את האזורים הנגועים מיד במים במשך 15 דקות לפחות. פנו לקבלת עזרה רפואית אם תסמינים הנובעים מחמוגע עם חנוזל נמשכים לאחר חטיפה.



סכנה

כדי למנוע התחשמלות, אין להסיר את מכסה הפלסטיק המגן על חלקו התחתון של הכרטיס ההפוך.



סכנה

אף שהסוללות הראשיות הן בעלות מתח נמוך, סוללה מקוצרת או מוארכת עלולה להפיק זרם מספיק לגרימת כוויות או להצתת חומרים דליקים.



סכנה

אלא אם כן מותרת 'החלפה חמה' של ה-FRU המוחלף, פעלו כדלהלן לפני חסרתו: כבו את המחשב, נתקו את כל כבלי החשמל מחשקעים, הוציאו את מארז הסוללות ונתקו את כל הכבלים המחוברים.

## Japanese



危険

FRUの交換後、ThinkPadの電源を入れる前に、ねじ、バネ、その他の小さな部品がすべて正しい位置にあり、またThinkPadの内部で緩んでいないことを確認してください。  
これを確認するには、ThinkPadを振って、カチャカチャと音がしないか確かめます。金属部品や金属破片はショートの原因になることがあります。



危険

予備バッテリーの中には少量のニッケルとカドミウムが含まれているものがあります。したがって、予備バッテリーの分解、再充電、火または水の中への投棄、またはショートさせることは決して行わないでください。バッテリーを廃棄する場合は地方自治体の条例に従ってください。適切なパーツ・リストにあるバッテリーだけを使用してください。誤ったバッテリーを使用すると、バッテリーが発火したり、爆発したりすることがあります。



危険

バッテリー・パックには少量のニッケルが含まれています。バッテリー・パックを分解したり、火または水の中に投げ込んだり、ショートさせないでください。バッテリー・パックの廃棄にあたっては、地方自治体の条例または規則に従ってください。バッテリー・パックを交換するときは、適切なパーツ・リストにあるバッテリーだけを使用してください。誤ったバッテリーを使用すると、バッテリーが発火したり、爆発したりすることがあります。



## 危険

リチウム・バッテリーは、火災、爆発、または重症のやけどを引き起こすことがあります。バックアップ・バッテリーの充電、その極性コネクターの取り外し、バッテリー本体の分解、100℃(212°F)以上への加熱、焼却、電池の中身を水に浸すことはしないでください。バッテリーを廃棄する場合は地方自治体の条例に従ってください。適切なパーツ・リストにあるバッテリーだけを使用してください。誤ったバッテリーを使用すると、バッテリーが発火したり、爆発したりすることがあります。



## 危険

LCD が破損し、LCD 中の液体が目に入ったり、手に触れたりした場合は、液体が触れた部分を少なくとも 15 分間洗い流してください。洗い流した後に、液体によって何らかの症状が現れた場合は、医師の治療を受けてください。



## 危険

感電を防ぐため、インバーター・カードの下部を保護しているプラスチック・カバーを外さないでください。



## 危険

メイン・バッテリーの電圧は低くても、ショートしたり、接地したバッテリーが、作業者にやけどを負わせたり、可燃物を燃やすだけの電流を発生させる場合があります。



## 危険

交換しようとしている FRU がホット・スワップに対応していない場合、それを取り外す前に、コンピューターの電源をオフにし、すべての電源コードをコンセントから抜き、バッテリー・パックを取り外して、相互接続しているケーブルをすべて切り離してください。

## Korean



## 위험

FRU를 교체하고 나서 컴퓨터 전원을 켜기 전에 모든 나사, 스프링 및 기타 작은 부품들이 올바른 위치에 있는지, 컴퓨터 내부에 단단하게 연결되어 있는지 확인하십시오. 컴퓨터를 흔들어 달걀거리는 소리가 나지 않는지 확인하십시오. 금속 부품 또는 금속 조각은 누전을 일으킬 수 있습니다.



## 위험

일부 보조 배터리에는 소량의 니켈 및 카드뮴이 포함되어 있습니다. 보조 배터리를 분해하거나, 다시 충전하거나, 불 또는 물에 던지거나, 단락시키지 마십시오. 배터리 껍을 폐기할 때에는 해당 지역의 법률 규정을 따르십시오. 배터리 껍을 교체할 때에는 올바른 배터리만 사용하십시오. 올바르게 사용하지 않는 배터리를 사용하면 배터리가 발화되거나 폭발할 수 있습니다.



### 위험

배터리 팩에는 소량의 니켈이 포함되어 있습니다. 배터리 팩을 분해하거나, 불 또는 물에 던지거나, 단락시키지 마십시오. 배터리 팩을 폐기할 때에는 해당 지역의 법률 규정을 따르십시오. 배터리 팩을 교체할 때에는 올바른 배터리만 사용하십시오. 올바르게 사용하지 않은 배터리를 사용하면 배터리가 발화되거나 폭발할 수 있습니다.



### 위험

리튬 배터리는 화재, 폭발 또는 심각한 화상을 일으킬 수 있습니다. 리튬 배터리를 다시 충전하거나, 극성 커넥터를 제거하거나, 분해하거나, 100C(212F) 이상으로 가열하거나, 소각하거나, 전지 내용물을 물에 노출시키지 마십시오. 배터리를 폐기할 때에는 해당 지역의 법률 규정을 따르십시오. 올바른 배터리만 사용하십시오. 올바르게 사용하지 않은 배터리를 사용하면 배터리가 발화되거나 폭발할 수 있습니다.



### 위험

LCD가 파손되어 LCD 내부의 액체가 눈에 들어가거나 손에 묻으면 즉시 깨끗한 물로 15분 이상 닦아 내십시오. 씻은 후에 조금이라도 이상을 느끼면 즉시 병원에 가서 의사의 진찰을 받아야 합니다.



### 위험

전기적 위험을 방지하려면 인버터 카드의 아래 부분을 보호하는 플라스틱 덮개를 제거하지 마십시오.



### 위험

기본 배터리의 전압은 낮지만, 단락되거나 접지된 배터리는 화상을 입히기에 충분한 전류와 가연성 물질을 발생시킬 수 있습니다.



### 위험

FRU 교체 시 Hot Swap이 지원되지 않는 경우, FRU를 제거하기 전에 컴퓨터의 전원을 끄고, 전기 콘센트에서 전원 코드를 분리하고, 배터리를 제거한 후, 연결된 모든 케이블을 분리하십시오.

## Spanish



### PELIGRO

Antes de encender el sistema despues de sustituir una FRU, compruebe que todos los tornillos, muelles y demás piezas pequeñas se encuentran en su sitio y no se encuentran sueltas dentro del sistema. Compruébelo agitando el sistema y escuchando los posibles ruidos que provocarían. Las piezas metálicas pueden causar cortocircuitos eléctricos.



### **PELIGRO**

Algunas baterías de reserva contienen una pequeña cantidad de níquel y cadmio. No las desmonte, ni recargue, ni las eche al fuego o al agua ni las cortocircuite. Deséchelas tal como dispone la normativa local. Utilice sólo baterías que se encuentren en la lista de piezas. La utilización de una batería no apropiada puede provocar la ignición o explosión de la misma.



### **PELIGRO**

Las baterías contienen pequeñas cantidades de níquel. No las desmonte, ni recargue, ni las eche al fuego o al agua ni las cortocircuite. Deséchelas tal como dispone la normativa local. Utilice sólo baterías que se encuentren en la lista de piezas al sustituir la batería. La utilización de una batería no apropiada puede provocar la ignición o explosión de la misma.



### **PELIGRO**

La batería de repuesto es una batería de litio y puede provocar incendios, explosiones o quemaduras graves. No la recargue, ni quite el conector polarizado, ni la desmonte, ni caliente por encima de los 100°C (212°F), ni la incinere ni exponga el contenido de sus celdas al agua. Deséchela tal como dispone la normativa local.



### **PELIGRO**

Si la LCD se rompe y el fluido de su interior entra en contacto con sus ojos o sus manos, lave inmediatamente las áreas afectadas con agua durante 15 minutos como mínimo. Obtenga atención medica si se presenta algún síntoma del fluido despues de lavarse.



### **PELIGRO**

Para evitar descargas, no quite la cubierta de plástico que rodea la parte baja de la tarjeta invertida.



### **PELIGRO**

Aunque las baterías principales tienen un voltaje bajo, una batería cortocircuitada o con contacto a tierra puede producir la corriente suficiente como para quemar material combustible o provocar quemaduras en el personal.



### **PELIGRO**

Salvo que se permita el intercambio en caliente para la unidad sustituible localmente, realice lo siguiente antes de extraerla: apague el sistema, desconecte todos los cables de alimentación de las tomas de alimentación eléctrica, extraiga la batería y desconecte los cables de interconexión.

## Traditional Chinese



危險

完成 FRU 更換之後，在開啟電腦的電源之前，請確定所有螺絲、彈簧及其他小零件都已歸位，沒有遺留在電腦內部。  
若要確認這一點，請搖晃電腦，聽聽看是否有卡嗒的聲響。  
金屬零件或儀錶的火花會造成電線短路。



危險

部分備用電池含有微量的鎳和鎘。請勿拆開備用電池、再充電、丟入火或水中，或使其形成短路。請按照當地法令或規定來棄置電池。  
僅限使用零件清單中的電池。使用不適當的電池會導致電池起火或爆炸。



危險

電池套件含有微量的鎳。請勿拆開電池套件、丟入火或水中，或使其形成短路。請按照當地法令或規定來棄置電池套件。  
更換電池套件時，僅限使用零件清單中的電池。使用不適當的電池會導致電池起火或爆炸。



危險

鋰電池會導致起火、爆炸或嚴重燒傷。請勿再充電、拔除其電極接頭、拆開、加熱超過 100°C (212°F)、焚燒，或讓電池組成物浸到水。請按照當地法令或規定來棄置電池。  
僅限使用零件清單中的電池。使用不適當的電池會導致電池起火或爆炸。



危險

如果 LCD 破裂導致 LCD 流出的液體沾到您的眼睛或手，請立即以清水沖洗沾染部位至少 15 分鐘。如果在清洗後出現該液體所造成的任何症狀，請就醫治療。



危險

為避免電擊，請勿拆下轉換卡下面的塑膠護蓋。



危險

雖然主電池的電壓很低，但短路或接地電池所產生的電流，仍足以使人燒傷或使可燃物質起火。



危險

除非 FRU 允許以熱抽換來替換，否則請依下列方式將其移除：將電腦關機，拔除插座上所有電源線，移除電池包，並拔開任何交互連接的線材。

---

## Chapter 3. Diagnostics and troubleshooting

This chapter helps you identify and solve the hardware problems of your computer.

- “Overall procedures” on page 29
- “Diagnose the power system” on page 30
- “Diagnostics applications” on page 31
- “Lenovo Memory Self Repair” on page 33
- “Undetermined problems” on page 34
- “Symptom-to-CRU/FRU index” on page 34
- “Call Lenovo” on page 41

---

### Overall procedures

Follow the procedures below to identify the failing symptoms in as much detail as possible and try to re-create the failure to verify the symptom by running the diagnostic test or by repeating the operation:

Step 1. Quick diagnostics and troubleshooting:

- a. Update the operating system. See “Install, upgrade, and recover operating system” on page 123.
- b. Reconnect all cables and power cords.
- c. Restart the computer and all external devices.

Step 2. Further diagnostics and troubleshooting:

- a. If you suspect a software problem, see the documentation, including readme files and help information systems, that comes with the operating system or the software program.
- b. Determine if there are any problems with the power system. See “Diagnose the power system” on page 30.
- c. Run diagnostics applications to narrow down the issue. See “Diagnostics applications” on page 31.
- d. Have the memory self-repaired if the diagnostics applications report any memory problem. See “Lenovo Memory Self Repair” on page 33.
- e. For undetermined problems, see “Undetermined problems” on page 34.

Step 3. Determine if any action or hardware replacement is required based on the symptoms in “Symptom-to-CRU/FRU index” on page 34. Turn to Chapter 4 “Reference information for hardware replacement” on page 44 and Chapter 5 “Hardware replacement” on page 59 for detailed instructions on hardware replacement.

Step 4. If the diagnosing procedures above cannot help you isolate and repair the problems by yourself, save and print the log files. Then, contact Lenovo for additional support. See “Call Lenovo” on page 41.

#### Notes:

- The diagnostics tests are intended to test only ThinkPad products. The use of non-ThinkPad products, prototype cards, or modified options can lead to false indications of errors and invalid system responses.
- The troubleshooting information or the diagnostics applications might tell you that you need additional or updated device drivers or other software. You can get the latest technical information and download device drivers and updates from the Lenovo Support Web site at: <https://support.lenovo.com>.

- **Be extremely careful during such write operations as copying, saving, or formatting.** Drives in the computer that you are servicing sequence might have been altered. If you select an incorrect drive, data or programs might be overwritten.

---

## Diagnose the power system

If the computer cannot be turned on or you suspect problems with the power system, follow the instructions in this section to diagnose the ac power adapter, the built-in battery, and the coin-cell battery, if any. If any hardware removal or installation is required, turn to Chapter 4 “Reference information for hardware replacement” on page 44 and Chapter 5 “Hardware replacement” on page 59 for detailed instructions.

### Verify the ac power adapter and the built-in battery

To verify if a battery or an ac power adapter is functional, do the following:

- Step 1. Turn off the computer.
- Step 2. Connect the ac power adapter.
- Step 3. Turn on the computer. If the computer can be turned on, it means that either the battery or the ac power adapter is functional.
- Step 4. Insert a straightened paper clip into the emergency-reset hole to reset the computer.
  - If the computer is still powered on, it means that the ac power adapter is functional.
  - If the computer is powered off, move forward to “Diagnose the ac power adapter” on page 30.
- Step 5. Turn off the computer.
- Step 6. Disconnect the ac power adapter and turn on the computer.
  - If the computer can be turned on, it means that the battery is functional.
  - If the computer cannot be turned on, move forward to “Diagnose the built-in battery and operational charging” on page 31.

### Diagnose the ac power adapter

Try the following solutions one by one to diagnose and troubleshoot the issue if you suspect a problem with the ac power adapter:

- Step 1. Check if the power problem occurs only when the docking station or the port replicator is used. If yes, replace the docking station or the port replicator.
- Step 2. Check if the system status indicator blinks three times when an ac power source is connected. If no, check the power cord of the ac power adapter for correct continuity and installation.
- Step 3. Connect the computer to a power outlet, and restart the computer. Start the Vantage app and locate the **Power** section. The ac power adapter information is displayed. Then, follow the on-screen instructions.

#### Notes:

- Noise from the ac power adapter does not always indicate a defect.
- Ensure that you use the ac power adapter that is shipped with the computer to provide enough power to the computer. Otherwise, a message will be displayed, prompting you that the computer will not be charged or will be charged slowly.

## Diagnose the built-in battery and operational charging

- This system supports only batteries specially designed for this specific system and manufactured by Lenovo or an authorized manufacturer. The system does not support unauthorized batteries or batteries designed for other systems. If an unauthorized battery or a battery designed for another systems is installed, the system will not charge.

**Attention:** Lenovo has no responsibility for the performance or safety of unauthorized batteries, and provides no warranties for failures or damage arising out of their use.

- Move your pointer to the battery-status icon in the Windows notification area to check the battery status. The battery-status icon displays the percentage of battery power remaining and how long you can use your computer before you must charge the battery.

To check whether the battery charges properly during operation, do the following:

- Step 1. Discharge the battery to 50% or lower.
- Step 2. Connect the computer to ac power to charge the battery. If the battery status icon in the Windows notification area indicates that the battery is not charging, remove the battery and let it return to room temperature.
- Step 3. Reinstall the battery. If the battery is still not charging, replace the battery.
- Step 4. Check the battery status icon again. If the same error still exists, replace the system board.

---

## Diagnostics applications

The following table lists diagnostics applications available on your computer, their running environments, and brief introductions to each application.

Table 1. Diagnostics applications

Diagnostics application	Running environment	Brief introduction
“Hardware scan in Vantage” on page 31*	Run in the operating system.	The Vantage application is preinstalled on the computer. Hardware scan in the Vantage application is an effective hardware testing tool to help you identify the hardware problems of your computer.
“UEFI diagnostics application” on page 32*	Run in the UEFI BIOS.	A UEFI diagnostics application is preinstalled on the computer. This application enables you to view system information and test some hardware components in your computer, especially when you cannot start up the operating system.
<ul style="list-style-type: none"><li>• “Advanced diagnostics application (Windows version)” on page 32</li><li>• “Advanced diagnostics application (bootable versions for Linux/UEFI)” on page 33</li></ul>	Run in the operating system or boot from USB (Need to download).	Advanced diagnostics applications help you test a wider scope of hardware components in your computer that cannot be covered by hardware scan in the Vantage application or the UEFI diagnostics application.

\* for selected models

## Hardware scan in Vantage

To run the hardware scan in Vantage, do the following:

- Step 1. Launch the Vantage app.
- Step 2. Click **Hardware scan** or **Support Services → Hardware scan**.
- Step 3. Choose one of the following ways to run the hardware scan:

Click **Refresh Modules** and check the list of hardware components currently available in the computer. Select **QUICK SCAN** to test all the hardware components detected.

Select **CUSTOMIZE** to choose one or several hardware components to be tested.

- Step 4. If any hardware failure is detected, the result varies depending on the warranty status and varies by country or region. Follow the on-screen instructions to resolve the issue.

## UEFI diagnostics application

To run the UEFI diagnostics application, do the following:

- Step 1. Turn on the computer.
- Step 2. When the logo screen is displayed, repeatedly press and release the F10 key. The main screen of the UEFI diagnostics application is displayed.
- Step 3. Follow the instructions on the screen to use the application.

The following table displays the items on the main screen of the UEFI diagnostics application.

**Note:** Depending on the model, the items might differ slightly. If the computer does not contain the device or the BIOS does not support the corresponding protocol, the test item is not supported.

Table 2. Items on the main screen of the UEFI diagnostics application

Category	Items
Tests	<ul style="list-style-type: none"> <li>• Storage</li> <li>• Memory</li> <li>• Battery</li> <li>• CPU</li> <li>• Display</li> <li>• Fan</li> <li>• Keyboard</li> <li>• Mouse</li> <li>• Motherboard</li> <li>• Touch</li> </ul>
Tools	<ul style="list-style-type: none"> <li>• System Information</li> <li>• Bad Block Recovery</li> <li>• Smart Information</li> </ul>

Prepare a USB flash drive formatted in FAT32. After the test is executed, select **View Log → Save Log**. The test log is saved in the USB flash drive. You can view the log to find possible solutions or send the log to Lenovo for helps.

## Advanced diagnostics application (Windows version)

To use the advanced diagnostics application (Windows version), do the following:

- Step 1. Go to <https://support.lenovo.com/solutions/ht506581>.
- Step 2. Select a Windows package that fits your scenario for download.
- Step 3. Double-click the downloaded file and complete the installation.

Step 4. Launch the app, select the device to be tested, and follow the on-screen instructions for diagnostics.

After the test is completed, select **Export Log** to save the diagnostic result. You can view the log to find possible solutions or send the log to Lenovo for helps.

## Advanced diagnostics application (bootable versions for Linux/UEFI)

To use the advanced diagnostics application (bootable versions for Linux/UEFI), do the following:

Step 1. Prepare a USB flash drive larger than 2 GB and make a backup of the content on the USB flash drive.

**Note:** During the following diagnostic process, the content on the USB flash drive will be erased.

Step 2. Go to <https://support.lenovo.com/solutions/bootableusb>.

Step 3. Follow the on-screen instructions to create a bootable USB and run the application from the bootable USB.

After the test is executed, select **View Log → Export Log**. The test log is saved in the USB flash drive. You can view the log to find possible solutions or send the log to Lenovo for helps.

---

## Lenovo Memory Self Repair

Lenovo Memory Self Repair (hereafter referred to as repair tool) enables you to repair memory single-bit or single-row failure with internal redundant resources.

It is recommended that you use the repair tool in the following situations while your computer can be turned on normally:

- The operating system is unstable, such as having blue screen error or system crash.
- Any application operates abnormally, such as crashing or quitting unexpectedly.
- Any test result indicates memory-related errors.

Take the following steps to run the repair tool to diagnose the memory:

Step 1. Restart the computer.

Step 2. When the logo screen is displayed, trigger the repair tool by one of the following methods:

- Press F4.
- Press Enter to enter **Startup Interrupt Menu** and then press F4.
- Press F12 to enter **App Menu** and then select **Lenovo Memory Self Repair**.

Step 3. Read through the important information in the displayed window and click **Yes** to run the tool.

Step 4. Check the repair result on the pop-up dialog box. There are three types of results:

- **Memory Repaired:** it means that the memory failure is detected and repaired.
- **Memory failure detected but repair was unsuccessful:** it means that the memory failure is detected but cannot be repaired.
- **No failure detected:** it means that no memory failure is detected.

Step 5. Click **Continue** to turn on the computer.

Step 6. If the issue persists, you can try again or contact Lenovo for additional support.

---

## Undetermined problems

It is recommended that you take the steps below to isolate the failing CRU/FRU (if any) in the following situations:

- The diagnosing procedures above did not identify the device that has failed.
- Wrong devices are installed.
- System simply is not operating.

Step 1. Verify that all attached devices are supported by the computer.

Step 2. Turn off the computer.

Step 3. Visually check each CRU/FRU for damage. Replace any damaged CRU/FRU.

Step 4. Remove or disconnect all of the following devices:

- a. Non-ThinkPad devices
- b. Devices attached to the dock
- c. Printer, mouse, and other external devices
- d. Battery
- e. Solid-state drive
- f. External diskette drive or optical drive
- g. Memory module
- h. PC cards

Step 5. Turn on the computer to see whether the problem has been solved.

Step 6. If the problem does not recur, reconnect the removed or disconnected devices one at a time until you find the failing CRU/FRU.

Step 7. If the problem remains, replace the following FRUs one at a time (do not replace a nondefective FRU):

- a. System board
- b. Display assembly

---

## Symptom-to-CRU/FRU index

This section contains following information:

- “Error codes” on page 35
- “Error messages” on page 36
- “Battery-charge LED indicator status and diagnosis” on page 37
- “No-beep symptoms” on page 39
- “Display-related symptoms” on page 40
- “Intermittent problems” on page 41

### Notes:

- This index can help you check the errors of your computer and possible causes based on the failing symptoms. The most likely cause is listed first, in boldface type.
- This index can also help you determine, during regular servicing, what Customer Replaceable Units (CRUs) or Field Replaceable Units (FRUs) are likely to need to be replaced next.
- Steps of using this index:

1. If a numeric error code is displayed in power-on self-test (POST) or system operation, go to “Error codes” on page 35.
  2. If no numeric error code is displayed, check the narrative descriptions of the symptoms in “Error codes” on page 35, “Error messages” on page 36, “Battery-charge LED indicator status and diagnosis” on page 37, “No-beep symptoms” on page 39, and “Display-related symptoms” on page 40.
  3. If the symptoms are not described in this section, go to “Intermittent problems” on page 41.
- Do the CRU/FRU replacement or other actions in the sequence shown in the column headed “CRU/FRU or action, in sequence.” If replacing a CRU/FRU does not solve the problem, put the original part back in the computer. Do not replace a nondefective CRU/FRU.
  - For devices that are not supported by diagnostics codes in the ThinkPad notebook computers, see the devices’ own manuals.

## Error codes

- If a numeric error code is displayed in POST or system operation, use the error codes on the screen to diagnose failures. If more than one error code is displayed, begin the diagnosis with the first error code. Whatever causes the first error code might also cause false error codes.

**Note:** n in the error codes displayed can be any number.

- If no numeric error code is displayed, check the narrative descriptions of the symptoms to see if any action or hardware replacement is needed for your computer.

Table 3. Error codes

Symptom or error	CRU/FRU or action, in sequence
<b>0177</b> Bad SVP data, stop POST task – The checksum of the supervisor password in the EEPROM is not correct.	<b>Replace the system board.</b>
<b>0183</b> Bad CRC of Security Settings in EFI Variable. Enter the ThinkPad Setup program. – The checksum of the Security settings in the EFI Variable is not correct.	<ol style="list-style-type: none"> <li>1. <b>Run the ThinkPad Setup program. The settings will be corrected automatically. Then save the current settings by pressing F10.</b></li> <li>2. Replace the system board.</li> </ol>
<b>0187</b> EAIA data access error - The access to EEPROM is failed.	<b>Replace the system board.</b>
<b>0188</b> Invalid RFID Serialization Information Area.	<b>Replace the system board.</b>
<b>0189</b> Invalid RFID configuration information area - The EEPROM checksum is not correct.	<b>Replace the system board.</b>
<b>0190</b> Critical low-battery error	<ol style="list-style-type: none"> <li>1. <b>Charge the battery.</b></li> <li>2. Replace the battery.</li> </ol>
<b>0191</b> System Security - Invalid Remote Change requested.	<ol style="list-style-type: none"> <li>1. <b>Run the ThinkPad Setup program, and then save current setting by pressing F10.</b></li> <li>2. Replace the system board.</li> </ol>
<b>0199</b> System Security - Security password retry count exceeded.	<ol style="list-style-type: none"> <li>1. <b>Run the ThinkPad Setup program. The retry count will be reset. Then save the current settings by pressing F10.</b></li> <li>2. Replace the system board.</li> </ol>
<b>0270</b> Real Time Clock Error.	<b>Have the computer serviced.</b>

Table 3. Error codes (continued)

Symptom or error	CRU/FRU or action, in sequence
<b>0271</b> Check Date and Time settings.	<ol style="list-style-type: none"> <li>1. <b>Run ThinkPad Setup to reset the time and date.</b></li> <li>2. Replace the coin-cell battery and run the ThinkPad Setup program to reset the time and date.</li> </ol>
<b>1802</b> Unauthorized network card is plugged in - Turn off and remove the network card.	<ol style="list-style-type: none"> <li>1. <b>Remove the network card.</b></li> <li>2. Replace the system board.</li> </ol>
<b>1820</b> More than one external fingerprint reader is attached. Power off and remove all but the reader that you set up within your main operating system.	<b>Remove all but the reader that you set up for the authentication.</b>
<b>2100</b> Detection error on Main HDD (SSD0) or Detection error on Main HDD (HDD0)	<ol style="list-style-type: none"> <li>1. <b>Reseat the M.2 solid-state drive.</b></li> <li>2. Replace the M.2 solid-state drive.</li> <li>3. Replace the system board.</li> </ol>
<b>2110</b> Read error on Main HDD (SSD0) or Read error on Main HDD (HDD0)	<ol style="list-style-type: none"> <li>1. <b>Reseat the M.2 solid-state drive.</b></li> <li>2. Replace the M.2 solid-state drive.</li> <li>3. Replace the system board.</li> </ol>
<b>2200</b> Machine Type and Serial Number are invalid.	<b>Have the computer serviced.</b>
<b>2201</b> Machine UUID is invalid	<b>Replace the system board.</b>
<b>2202</b> Product Name is invalid.	<b>Have the computer serviced.</b>
<b>2203</b> System configuration is invalid.	<b>Have the computer serviced.</b>
<b>2204</b> System configuration data is invalid.	<b>Have the computer serviced.</b>

## Error messages

Check the narrative descriptions of the symptoms to see if any action or hardware replacement is needed for your computer:

Table 4. Error messages

Symptom or error	CRU/FRU or action, in sequence
Thermal sensing error.	Replace the system board.
The battery installed is not supported by this system and will not charge. Please replace the battery with the correct Lenovo battery for this system. Press the Esc key to continue.	Replace the battery.
This system does not support batteries that are not genuine Lenovo-made or authorized. The system will continue to boot, but may not charge unauthorized batteries. Press the Esc key to continue.  <b>Attention:</b> Lenovo has no responsibility for the performance or safety of unauthorized batteries, and provides no warranties for failures or damage arising out of their use.	Replace the battery.

## Battery-charge LED indicator status and diagnosis

The battery-charge LED indicator (hereafter referred to as LED indicator) blinks to help you diagnose and solve some computer problems.

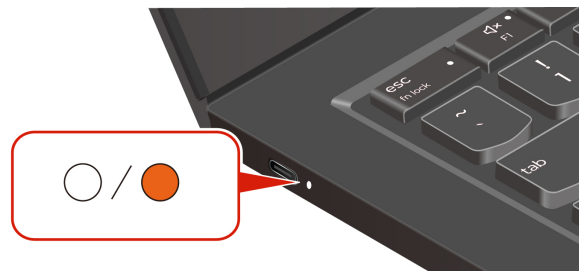

### Indicator blinking patterns



The LED indicator blinks amber first and then white continually, consisting of different blinking patterns. Each blinking pattern corresponds to an error code. For example, when the LED indicator blinks amber once ● and then blinks white twice ○○, the blinking pattern ●○○ corresponds to error code 0001.

### Notes:

- The LED indicator blinks automatically only when the error in the following table occurs.
- The LED indicator blinks continually until the computer turns off. If you need to interrupt the process, press power button for a few seconds.
- We recommend that you speak to our Customer Support Center before attempting to service the computer yourself so that you can be directed to the correct documentation and repair information. It might be recommended to have a Lenovo-authorized service provider repair your computer depending on the complexity of the error or fault.

Refer to the blinking patterns and error codes in the table below to solve your computer problems.

Blinking patterns	Error codes	Solutions
● ○ ○	0001: Reset error (platform reset not de-asserted)	<ol style="list-style-type: none"> <li>1. Do the following to perform a hard reset:               <ol style="list-style-type: none"> <li>a. Disconnect your computer from ac power.</li> <li>b. Press and hold the power button for at least 14 seconds, or insert a straightened paper clip into the emergency reset hole to cut off power supply temporarily.</li> <li>c. Restart the computer with ac power connected.</li> </ol> </li> </ol> <p><b>Note:</b> When performing a hard reset via power button, the LED indicator might stop blinking in a few seconds. Keep holding the power button for at least 14 seconds to complete the hard reset.</p> <ol style="list-style-type: none"> <li>2. If step 1 does not work, replace the system board (service provider only).</li> </ol>
● ○ ○ ○	0002: Internal bus error	Replace the system board (service provider only).
● ○ ○ ○ ○	0003: Non-Volatile Memory programming error in system power circuit	Replace the system board (service provider only).
● ● ○	0282: Memory module error	<ol style="list-style-type: none"> <li>1. Reinstall or replace the memory module.</li> <li>2. If step 1 does not work, replace the system board (service provider only).</li> </ol>
● ● ○ ○	0283: PCI resource error	<ol style="list-style-type: none"> <li>1. Remove PCIe devices (the M.2 card, PCIe card, and so on) (service provider only).</li> <li>2. If step 1 does not work, replace the system board (service provider only).</li> </ol>
● ● ○ ○ ○	0284: TCG-compliant functionality-related error (might be the BIOS code validation failure)	Replace the system board (service provider only).
● ● ○ ○ ○ ○	0285: TCG-compliant functionality-related error (might be the TPM initialization failure)	Replace the system board (service provider only).
● ● ● ○	0286: Integrated graphics error	Replace the system board (service provider only).
● ● ● ○ ○	0287: Discrete graphics error	<ol style="list-style-type: none"> <li>1. Reinstall or replace the discrete graphics card (service provider only).</li> <li>2. If step 1 does not work, replace the system board (service provider only).</li> </ol>

Blinking patterns	Error codes	Solutions
	0288: Computer display error	<ol style="list-style-type: none"> <li>1. Reconnect the display cable on both the system board side and the computer display side (service provider only) and check the display panel.</li> <li>2. If step 1 does not work, connect an external display to your computer and check the status (customer or service provider). <ul style="list-style-type: none"> <li>• If the external display works, replace the display panel (service provider only).</li> <li>• If the external display does not work, replace the system board (service provider only).</li> </ul> </li> </ol>
	0281: General embedded controller error	Replace the system board (service provider only).

## No-beep symptoms

Check the narrative descriptions of the symptoms to see if any action or hardware replacement is needed for your computer:

Table 5. No-beep symptoms

Symptom or error	CRU/FRU or action, in sequence
No beep, power-on indicator on, display blank, and no POST.	<ol style="list-style-type: none"> <li>1. <b>Run display Self Test.</b></li> <li>2. Ensure that every connector is connected tightly and correctly.</li> <li>3. Reseat memory module.</li> <li>4. Replace the system board.</li> </ol>
No beep, power-on indicator on, and display blank during POST.	<ol style="list-style-type: none"> <li>1. <b>Run display Self Test.</b></li> <li>2. Reseat memory module.</li> <li>3. Replace the system board.</li> </ol>
The power-on password prompt appears.	A power-on password or a supervisor password is set. Type the password and press Enter.
No beep, power-on indicator on, display blank, and LED indicators on Esc, F1 and F4 blink sequentially during POST.	<p>UEFI BIOS is performing memory retraining. The memory retraining might occur if any of the following situations is detected:</p> <ul style="list-style-type: none"> <li>• Memory module replacement</li> <li>• Total Memory Encryption setting change in UEFI BIOS</li> <li>• Memory Reference Code [MRC] change when UEFI BIOS updates</li> </ul> <p>Do not press the power button to interrupt this process. Wait a few minutes until the logo screen is displayed.</p>

Table 5. No-beep symptoms (continued)

Symptom or error	CRU/FRU or action, in sequence
No beep, power-on indicator on, display blank, and LED indicators on Esc, F1 and F4 blink during POST.	<p>UEFI BIOS is self-recovering. If the UEFI BIOS is corrupted or maliciously attacked, it can self-recover and restore computer from the last uncorrupted and secure backup.</p> <p>The blinking LED indicators on keys indicate the self-recovery progress:</p> <ul style="list-style-type: none"> <li>• LED indicator on Esc blinks: 0% to 32%</li> <li>• LED indicators on Esc and F1 blink simultaneously: 33% to 65%</li> <li>• LED indicators on Esc, F1 and F4 blink simultaneously: 66% to 100%</li> </ul> <p>Do not press the power button to interrupt this progress. Wait a few minutes until the logo screen is displayed.</p>
The NVMe password prompt appears.	An NVMe password is set. Type the password and press Enter.

## Display-related symptoms

**Important:** The TFT display for the notebook computer contains many thin-film transistors (TFTs). The presence of a small number of dots that are missing, discolored, or always lighted is characteristic of TFT display technology, but excessive pixel problems can cause viewing concerns.

If the display you are servicing has two or less visible defective pixels, it should not be considered faulty. However, if the display has three or more visible defective pixels, it will be deemed as defective by Lenovo and it should be replaced.

### Notes:

- This policy applies to all ThinkPad Notebooks purchased on 1 January, 2008 or later.
- Lenovo will not provide warranty replacement if the display is within specifications because we cannot guarantee that any replacement display will have zero pixel defects.
- One pixel consists of R, G, B sub-pixels.

## Display Self Test

When you turn on the computer and the display goes black, run display Self Test to help you determine whether the display functions normally.

To run display Self Test:

- Step 1. Ensure that the computer is connected to ac power. Then, press the power button for about seven seconds to turn off the computer.
- Step 2. Press Fn, left Ctrl, and the power button at the same time. If the computer displays five solid colors in sequence across the entire screen, it indicates that the display functions normally.
- Step 3. The test lasts for about 20 seconds and then exits automatically. You also can press the power button to exit the test.

Table 6. Display-related symptoms

Symptom or error	FRU or action, in sequence
No beep, power-on indicator on, and a blank display during POST.	<ol style="list-style-type: none"> <li>1. <b>Run display Self Test.</b></li> <li>2. Replace the system board.</li> </ol>
<ul style="list-style-type: none"> <li>• Display black screen.</li> <li>• Display too dark.</li> <li>• Display brightness cannot be adjusted.</li> <li>• Display contrast cannot be adjusted.</li> </ul>	<ol style="list-style-type: none"> <li>1. <b>Reseat the display connectors.</b></li> <li>2. Replace the display assembly.</li> <li>3. Replace the system board.</li> </ol>
<ul style="list-style-type: none"> <li>• Display screen unreadable.</li> <li>• Characters missing pixels.</li> <li>• Screen abnormal.</li> <li>• Wrong color displayed.</li> </ul>	<ol style="list-style-type: none"> <li>1. <b>See important note for “Display-related symptoms”.</b></li> <li>2. Reseat all display connectors.</li> <li>3. Replace the display assembly.</li> <li>4. Replace the system board.</li> </ol>
Horizontal or vertical lines displayed on display.	<b>Replace the display assembly.</b>

## Intermittent problems

If no numeric error code is displayed and the symptoms are not described in the sections above, check if there is any intermittent system-hang problem. The problems might happen due to a variety of causes that have nothing to do with a hardware defect, such as cosmic radiation, ESD, or software errors. If an intermittent problem recurs, analyze the problem in the following steps to see whether it’s necessary to replace any CRUs/FRUs:

- Step 1. Run the diagnostics test for the system board in loop mode **at least 10 times**.
- Step 2. If no error is detected, do not replace any CRUs/FRUs.
- Step 3. If any error is detected, replace the CRU/FRU shown by the CRU/FRU code. Rerun the test to verify that no more errors exist.

---

## Call Lenovo

If you have tried to correct the problem yourself and still need help, you can call Lenovo Customer Support Center.

## Before you contact Lenovo

Prepare the needed information before you contact Lenovo.

1. Record the problem symptoms and details:
  - What is the problem? Is it continuous or intermittent?
  - Any error message or error code?
  - What operating system are you using? Which version?
  - Which software applications were running at the time of the problem?
  - Can the problem be reproduced? If so, how?
2. Record the system information:
  - Product name.
  - Machine type and “serial number” on page 42.

## Find your service QR code and serial number

This topic helps you find service QR code and serial number.

Scan the QR code on the base cover assembly to view the following information:

- Your product information and warranty status
- The latest Lenovo-verified drivers and software
- Troubleshooting and diagnosing solutions when hardware or software issue is encountered
- Customer support center and e-ticket entry for professional support

You can find your serial number via:

- **Dashboard** or **Device** in the **Vantage** app
- Serial-number label of your computer (shown as below illustration)

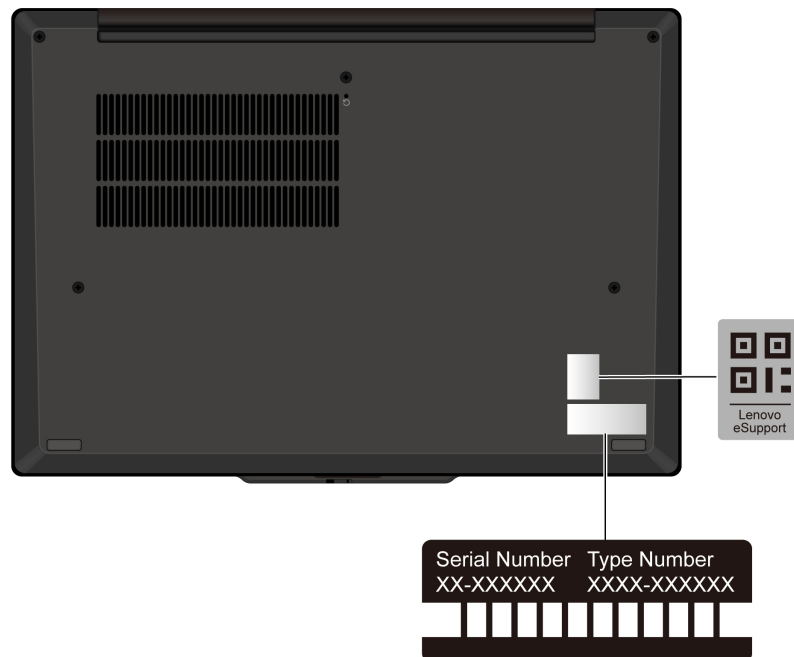

## Lenovo Customer Support Center

During the warranty period, you can call Lenovo Customer Support Center for help.

### Telephone numbers

For a list of the Lenovo Support phone numbers for your country or region, go to <https://pcsupport.lenovo.com/supportphonenumber> for the latest phone numbers.

**Note:** Phone numbers are subject to change without notice. If the number for your country or region is not provided, contact your Lenovo reseller or Lenovo marketing representative.

## Nonwarranted items and activities

During the warranty period, the customer may be responsible for repair costs if the computer damage was caused by misuse, accident, modification, unsuitable physical or operating environment, or improper

maintenance by the customer. Following is a list of some common items that are not covered under warranty and some symptoms that might indicate that the system was subjected to stress beyond normal use.

### **Items not covered by warranty**

- Display panel cracked from the application of excessive force or from being dropped
- Scratched (cosmetic) parts
- Distortion, deformation, or discoloration of the cosmetic parts
- Plastic parts, latches, pins, or connectors that have been cracked or broken by excessive force
- Damage caused by liquid spilled into the system
- Damage caused by the improper insertion of a PC Card or the installation of an incompatible card
- Diskette drive damage caused by pressure on the diskette drive cover, foreign material in the drive, or the insertion of a diskette with multiple labels
- Damaged or bent diskette eject button
- Fuses blown by attachment of a nonsupported device
- Forgotten computer password (making the computer unusable)
- Sticky keys caused by spilling a liquid onto the keyboard
- Use of an incorrect ac power adapter on laptop products

### **Symptoms that might indicate damage caused by non-warranted activities**

- Missing parts might be a symptom of unauthorized service or modification.
- Obvious damage of a solid-state drive. If the spindle of a solid-state drive becomes noisy, the solid-state drive might have been dropped or subject to excessive force.

---

## Chapter 4. Reference information for hardware replacement

---

### Parts

Before proceeding with part replacement, get to know part type definition, learn to look up a part on the Lenovo Support Web site, and gain an overview of all CRUs/FRUs in this computer through the exploded view.

### Part type definition

Your computer contains the following types of “Customer Replaceable Unit” (CRU)s and “Field Replaceable Unit” (FRU)s:

- **Self-service CRUs:** Refer to parts that can be replaced easily by customer themselves or by trained service technicians at an additional cost.
- **Optional-service CRUs:** Refer to parts that can be replaced by customers with a greater skill level. Trained service technicians can also provide service to replace the parts under the type of warranty designated for the customer’s product.
- **FRUs:** Refer to parts that are more complicated to replace and it is recommended that these parts should be replaced by trained service technicians. If customers elect to replace the FRU by themselves, we recommend that you ensure the correct instructions are carefully followed.

#### Important notes:

- **CRU statement for customers:**
  - You can resolve some problems with your product by replacing a CRU. *For self-service CRUs, installation is your responsibility. For optional-service CRUs, you can either install the CRU yourself or you can request that a Service Provider install the CRU according to the warranty service for your product.*
  - If you intend on installing the CRU, Lenovo will ship the CRU to you. CRU information and replacement instructions are shipped with your product and are available from Lenovo at any time upon request.
  - You can find a list of CRUs for your product in this *Hardware Maintenance Manual*. To find this manual, go to <https://support.lenovo.com> and search by the product name or serial number. Then, click **Guides & Manuals**.
  - When you are required to return the defective CRU, (1) return instructions, a prepaid shipping label, and a container will be included with the replacement CRU; and (2) you might be charged for the replacement CRU if Lenovo does not receive the defective CRU within thirty (30) days of your receipt of the replacement CRU. See your Lenovo Limited Warranty documentation for full details.
- **CRU/FRU statement:**
  - Each CRU/FRU is available for all types or models, unless otherwise specified.
  - **Replace a CRU/FRU only with another CRU/FRU of the correct model.** When you replace a CRU/FRU, ensure that the model of the product and the CRU/FRU part number are correct.
  - **A CRU/FRU should not be replaced because of a single unreproducible failure.** Single failures can occur for a variety of reasons that have nothing to do with a hardware defect, such as cosmic radiation, ESD, or software errors. Consider replacing a CRU/FRU only when a problem recurs. If you suspect that a CRU/FRU is defective, clear the error log and run the test again. If the error does not recur, do not replace the CRU/FRU.
  - **Be careful not to replace a nondefective CRU/FRU.**

- When you need to return a CRU/FRU after servicing a computer, include the following information in the parts exchange form or parts return form that you attach to it:
  1. Name and phone number of service technician
  2. Date of service
  3. Date on which the machine failed
  4. Date of purchase
  5. Failure symptoms, error codes appearing on the display, and beep symptoms
  6. Procedure index and page number in which the failing CRU/FRU was detected
  7. Failing CRU/FRU name and part number
  8. Machine type, model number, and serial number
  9. Customer's name and address

## **Look up a part**

1. For more detailed CRU/FRU information, including part numbers, descriptions, and substitution part numbers, go to <https://support.lenovo.com/partslookup>.
2. Type the product name, the machine type or the serial number in the corresponding field to get a general CRU/FRU list.

## **Exploded view and part list**

By the exploded view and the part list, you can find the images, names, and types of all the CRU/FRUs of your computer.

## Major FRUs and CRUs

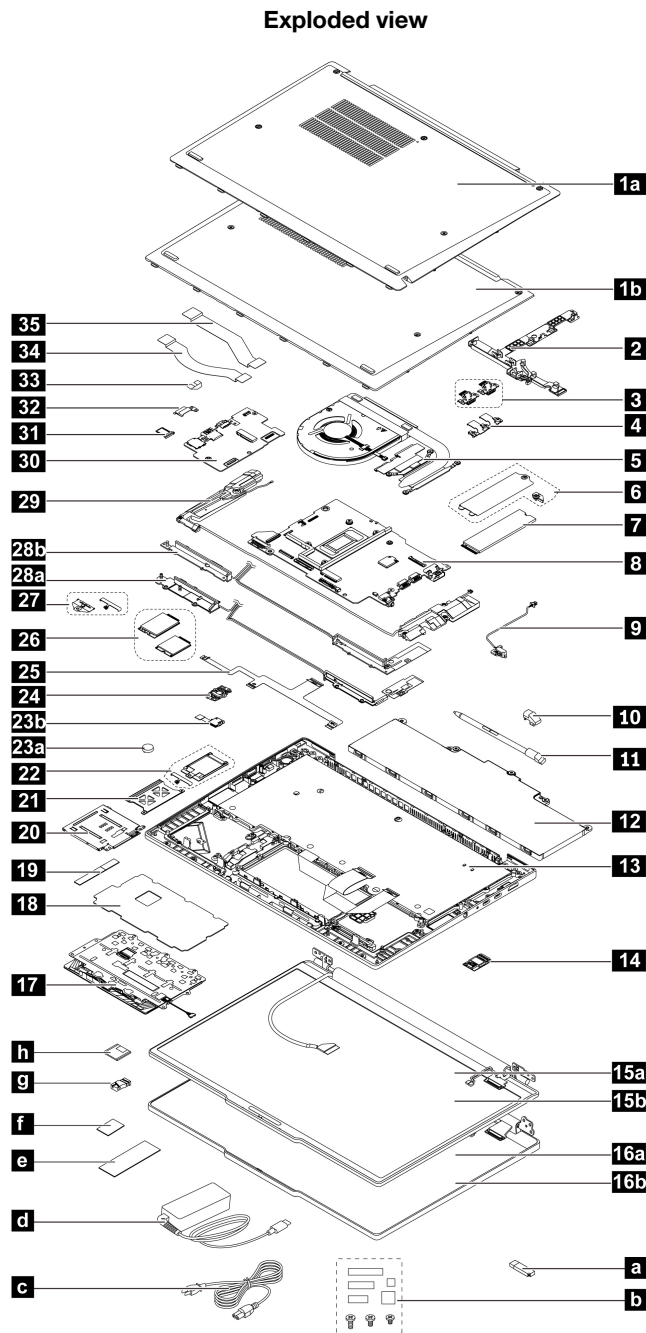

## Part list

### Self-service CRUs:

- 1a 1b** “Base cover assembly” on page 61
- 6 7** “M.2 solid-state drive and M.2 solid-state drive bracket” on page 63
- 10** “Dummy Pen (for selected 2-in-1 models)” on page 76
- 11** “Lenovo Integrated Pen (for selected 2-in-1 models)” on page 76
- 31** “Remove the nano-SIM card and nano-SIM-card tray (for selected models)” on page 60
- c** power cord
- d** ac power adapter

### Optional-service CRU:

- 3 4** “Replaceable USB-C module and replaceable USB-C module bracket” on page 67
- 12** “Built-in battery” on page 69
- 22** “Dummy wireless WAN module and wireless WAN module bracket” on page 66
- 26 27** “Wireless WAN module and wireless WAN module bracket (for selected models)” on page 65

### FRUs:

- 2** “Camera cable guide” on page 92
- 5** “Thermal fan assembly” on page 71
- 6 7** “M.2 solid-state drive and M.2 solid-state drive bracket” on page 63
- 8** “System board” on page 93
- 9** “Pen charge cable(for selected 2-in-1 models)” on page 77
- 13** “Keyboard assembly” on page 103
- 14** “NFC module (for selected models)” on page 78

## Exploded view

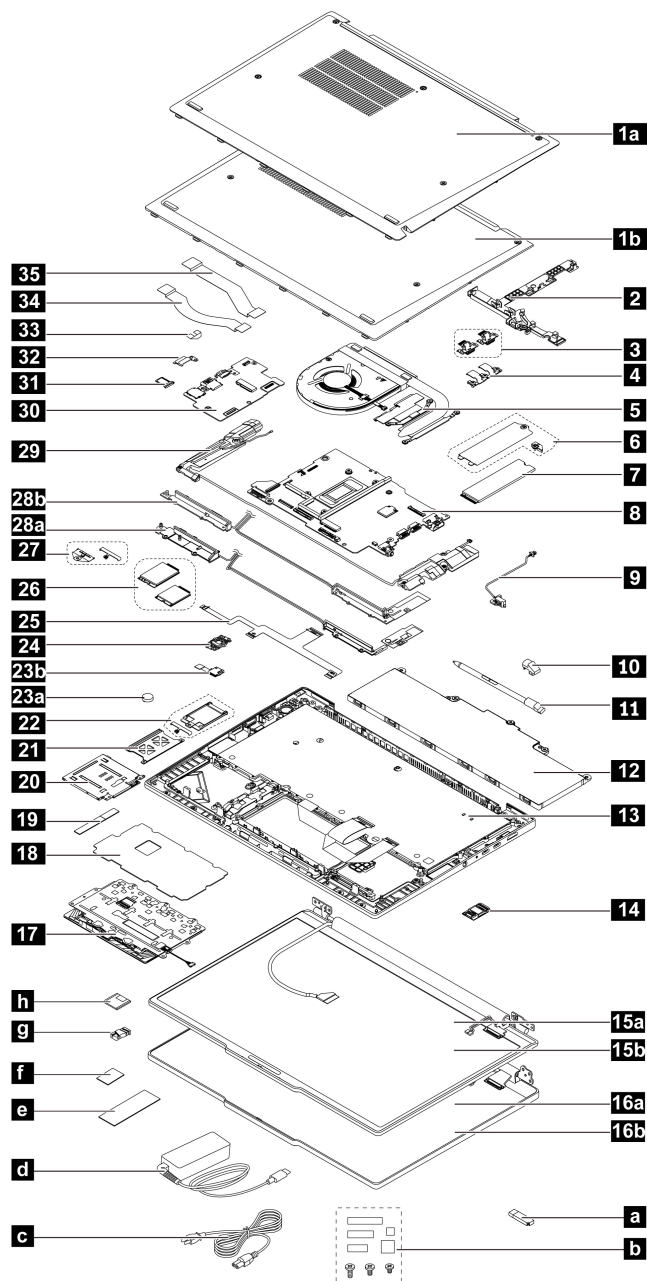

## Part list

### FRUs:

- 15** “Display unit (ThinkPad T14s Gen 7)” on page 82
- Note : For OLED SKU, display unit is a single FRU
- 16** “Display unit (ThinkPad T14s 2-in-1 Gen 2)” on page 85
- 17 18** “Trackpad and Trackpad waterproof mylar” on page 100
- 19 20** “Smart card reader and audio smart card sponge (for selected models)” on page 78
- 21** “Dummy smart card (for selected models)” on page 80
- 23a 23b 24** “Power button with or without fingerprint reader and fingerprint reader bracket” on page 99
- 25** “Smart card reader-Trackpad-NFC cable (for selected models)” on page 81
- 28a 28b** “Wireless WAN antenna assembly (for selected models)” on page 74
- 29** “Speaker assembly and wireless WAN MIMO antenna kits” on page 74
- 30** “Sub-USB board” on page 91
- 32** “Sub-USB board bracket” on page 88
- 33** “Fingerprint reader cable” on page 89
- 34 35** “USB I/O cable and wireless WAN I/O cable” on page 90
- a** Lenovo factory recovery USB key\*
- b** Miscellaneous parts
- e** Wireless WAN module thermal pad\*
- f** M.2 solid-state drive thermal pad
- g** WLAN cable rubber\*
- h** WLAN PC mylar\*

\* for selected models

### Notes:

- The Lenovo factory recovery USB key **a** is used to restore the Microsoft Windows operating system. It might not come with the computer, and a user might order it from <https://pcsupport.lenovo.com/lenovorecovery>, though additional shipping and handling fees might apply.
- Miscellaneous parts **b** contains the following items:
  - Screw kit, see “Screws” on page 48
  - Mechanical miscellaneous kit: Thermal grease type and sheet type

- Label kit: label and spec

## LCD FRUs and CRUs(ThinkPad T14s Gen 7)

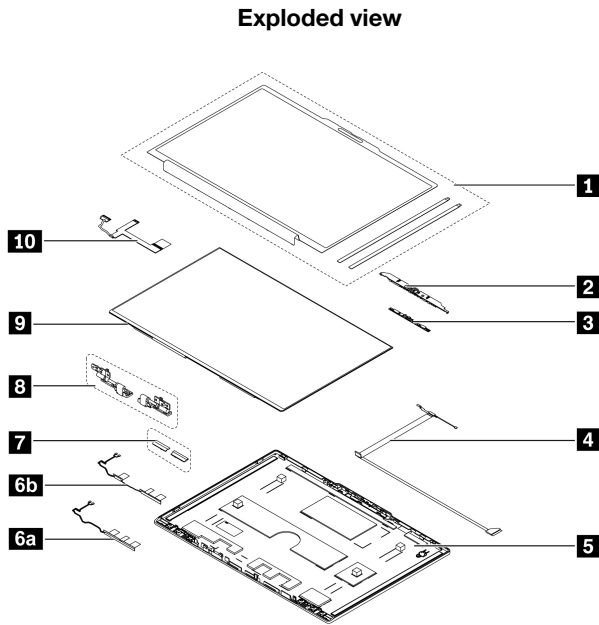

### Part list

#### FRUs:

- 1 9 10** “LCD bezel, LCD panel, LCD cable and elastic adhesive tapes” on page 104
- 2** “Camera shutter” on page 108
- 3 4** “Camera-and-microphone module and cable (for selected models)” on page 109
- 5** “LCD cover assembly” on page 113
- 6a 6b** “Wireless LAN antenna assembly” on page 110
- 7 8** “Strip cover and LCD hinges” on page 112

## LCD FRUs and CRUs(ThinkPad T14s 2-in-1 Gen 2)

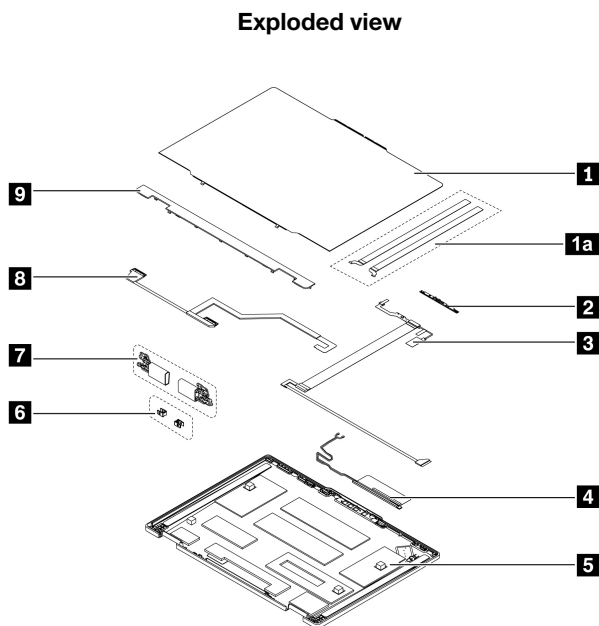

### Part list

#### FRUs:

- 1 1a 8** “LCD cable, LCD panel and elastic adhesive tapes” on page 115
- 2 3** “Camera-and-microphone cable and module (for selected models)” on page 119
- 4** “WLAN antenna assembly ” on page 120
- 5** “LCD cover assembly for 2-in-1 models” on page 121
- 6 7** “LCD hinges and hinges cover” on page 114
- 9** “LCD strip cover” on page 113

\* for selected models

## Screws

This section provides the screw list of this computer and the screw notices you need to know before hardware replacement.

## Screw list

The following table includes screw specifications, torque information, and screw colors of this product.

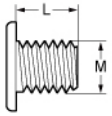

The number after the letter L refers to the length of the screw shank measured from under the head to the tip of the screw. The number after the letter M refers to the width of the screw shank measured across the outermost points in a metric screw.

Table 7. Screw list of this product

Thread (mm)	Length (mm)	Torque (kgf.cm)	Color
M2.5	L2.2	3 ± 0.3	Silver
M2.5	L4.5	3 ± 0.3	Black
M1.2	L1.4	0.4 ± 0.05	Black
M1.2	L1.7	0.4 ± 0.05	Black
M2	L3	1.85 ± 0.15	Black
M2	L3.5	1.85 ± 0.15	Black
M1.6	L2.1	1.1 ± 0.15	Black
M1.6	L2.6	1.1 ± 0.15	Silver
M2	L1.8	1.85 ± 0.15	Black
M2	L1.6	1.85 ± 0.15	Black
M2	L4	1.85 ± 0.15	Black
M2.5	L1.98	3 ± 0.3	Black
M2.5	L1.8	3 ± 0.3	Black
M2.5	L2.8	3 ± 0.3	Black

You can refer to the following table to choose a properly matched screwdriver.

### Notes:



-  The Phillips head screw has a cross-shaped slot in the screw head.
-  The Torx head screw has a six-pointed star in the screw head.

Table 8. Choose a properly matched screwdriver

Screw head type	Thread (mm)	Screwdriver type
Phillips head	M1.6 – M2	PH0 or PH1
Phillips head	> M2	PH1

## Screw notices

Do the following when you service the computer:

- Carefully retain and reuse all screws.
- Keep the screw kit in your tool bag. For the part number of the screw kit, go to: <https://support.lenovo.com/partslookup>
- Use the correct screw as shown in the CRU/FRU replacement procedures.

- Turn the screws in the direction as given by the arrow in the CRU/FRU replacement illustration.
- If you have a torque screwdriver, tighten all screws firmly to the torque specified in the screw information table for each step.
- Ensure torque screwdrivers are calibrated correctly following country specifications.

Loose screws can cause a reliability problem. In your computer, this problem is addressed with special nylon-coated screws that have the following characteristics:

- They maintain tight connections.
- They do not easily come loose, even with shock or vibration.
- They are harder to tighten.

Tighten screws as follows:

- **Plastic to plastic**

Turn an additional angle of 90 degrees after the screw head touches the surface of the plastic part.

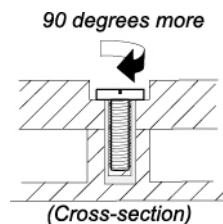

- **Logic card to plastic**

Turn an additional angle of 180 degrees after the screw head touches the surface of the logic card.

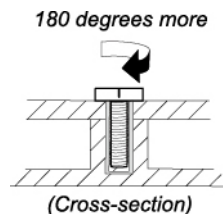

---

## Service tools

The following table lists all tools for servicing Lenovo products. Tools required to service a part are listed in the specific part disassembly topic. Prepare them before you service the product.

Table 9. Service tools







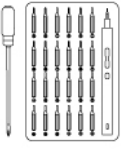

No.	Reference image	Tool name	Specification	Tool type
1		Screwdriver set	<ul style="list-style-type: none"> <li>• PH0, PH00, PH1, PH2</li> <li>• T5, T15, T20, T30</li> </ul> <p><b>Note:</b> Use a screwdriver with the shank length greater than 6 inches for Desktop, Workstation, and Smart device product.</p>	Common tool
2		Pry tool	N/A	Common tool
3		Tweezers	<ul style="list-style-type: none"> <li>• Conductive</li> <li>• Isolated</li> </ul>	Common tool
4		Suction cup	N/A	Common tool
5		Hexagonal socket	<ul style="list-style-type: none"> <li>• For VGA: H5 mm or H4.8 mm</li> <li>• For Tiny antenna: H8 mm</li> </ul>	Common tool
6		Adjustable torque screwdriver	0.2 Nm to 4.0 Nm, Threadripper CPU, CAMM, etc	Common tool
7		ESD mat	N/A	Common tool
8		USB flash drive	For Golden Key, Chrome Reloads, AutoPilot, etc	Common tool

Table 9. Service tools (continued)











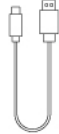

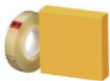

No.	Reference image	Tool name	Specification	Tool type
9		USB-C to USB-A converter	N/A	Common tool
10		Thermal pad	Variety of thickness, most common 0.5mm thickness pad under the component	Consumable tool
11		Thermal interface materials	N/A	Consumable tool
12		Acetate tape	N/A	Consumable tool
13		Polyimide tape	N/A	Consumable tool
14		Mylar tape	N/A	Consumable tool
15		Electrical tape	N/A	Consumable tool
16		Double-sided tape	N/A	Consumable tool
17		Conductive tape	N/A	Consumable tool

Table 9. Service tools (continued)

No.	Reference image	Tool name	Specification	Tool type
18		Eraser	N/A	Consumable tool
19		Cleaning wipes	N/A	Consumable tool
20		Touchpad jig (this might come with touchpad)	N/A	Consumable tool
21		Heat gun	N/A	Special tool
22		Brown brush	25 mm to 35 mm wide	Special tool
23		Contact cleaner spray	WD-40 Contact cleaner for battery connector	Special tool
24		Hexagonal socket	H17 mm	Special tool

## Connectors and cables for replacement

This topic provides information to help Lenovo-authorized service technicians identify connectors and cables for replacement purpose. To view each CRU/FRU and the exploded illustration of the computer, see “Exploded view and part list” on page 45.

**Note:** Depending on your computer model, some connectors or cables might not be available.

## System board connectors and cables

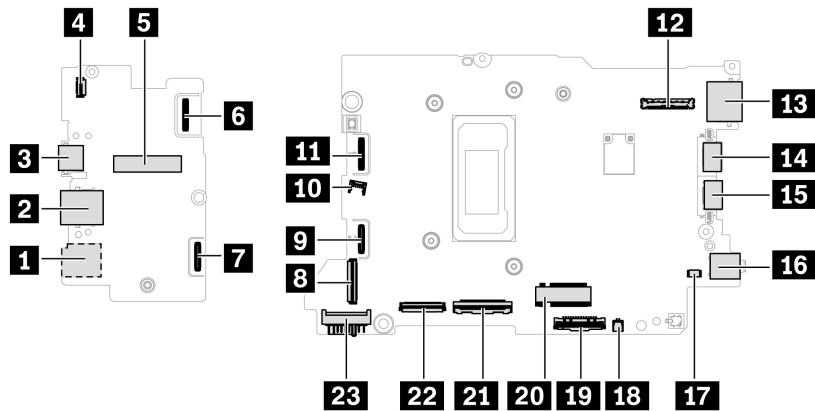

Table 10. System board connectors and cables for replacement

No.	Connector/feature	Internal cable required	Cable connection
<b>1</b>	Nano-SIM-card slot (external)	No	Insert a Nano Subscriber Identity Module (SIM) card into this slot.
<b>2</b>	USB-A connector (USB 5Gbps, Always On USB) (external)	No	Connect a USB-A compatible device to this connector.
<b>3</b>	USB-C power connector (Thunderbolt 4) (external)	No	Connect a USB-C compatible or Thunderbolt 4 compatible device to this connector.
<b>4</b>	Power button with fingerprint reader connector(internal)	Power button with fingerprint reader cable	Connect the cable to this connector.
<b>5</b>	Wireless-WAN-module slot (internal)	No	Insert a wireless WAN module into this slot.
<b>6</b> <b>11</b>	Sub-USB board connector and System board connector(internal)	USB I/O cable	Connect one end to the Sub-USB board connector, and the other end to the System board connector.
<b>7</b> <b>9</b>	Sub-USB wireless WAN connector and System board connector (internal)	Wireless WAN I/O cable	Connect one end to the Sub-USB wireless WAN connector, and the other end to the the System board connector.
<b>8</b>	Camera connector (internal)	camera cable	Connect one end to the camera module and the other end to this connector.
<b>10</b>	Thermal fan connector (internal)	No	The thermal fan comes with the cable. Connect the cable to this connector.
<b>12</b>	LCD connector (internal)	LCD cable	Connect one end to the LCD panel and the other end to this connector.
<b>13</b>	HDMI connector (external)	No	Connect a compatible digital audio device or video monitor to this connector.

Table 10. System board connectors and cables for replacement (continued)

No.	Connector/feature	Internal cable required	Cable connection
<b>14</b>	For Intel models: USB-C power connector ( Thunderbolt 4 ) (external)  For AMD models: USB-C power connector ( 5Gbps ) (external)	No	Connect a USB-C compatible or Thunderbolt 4 compatible device to this connector.
<b>15</b>	USB-C power connector (Thunderbolt 4) (external)	No	Connect a USB-C compatible or Thunderbolt 4 compatible device to this connector.
<b>16</b>	Audio connector (external)	No	Connect headphones or a headset with a 3.5-mm (0.14-inch) and 4-pole plug to this connector.
<b>17</b>	Speaker assembly connector (internal)	No	The speaker assembly comes with the cable. Connect the cable to this connector.
<b>18</b>	Pen connector(internal)	Pen cable	Connect one end to the Pen connector and the other end to Pen module holder.
<b>19</b>	TrackPoint connector (internal)	TrackPoint cable	Connect one end of the cable to the TrackPoint and the other end to this connector.
<b>20</b>	M.2 Solid-state drive slot (internal)	No	Insert a solid state drive into this slot.
<b>21</b>	Keyboard connector (internal)	Keyboard assembly cables	The keyboard assembly comes with the cables. Connect the cables to these connectors.
<b>22</b>	Trackpad connector (internal)	Smart card reader-Trackpad—NFC cable	For smart card reader-trackpad—nfc cable, connect one end of the cable to the smart card reader, one end to the trackpad, one end to the NFC module, and the other end to this connector.
<b>23</b>	Battery connector (internal)	No	Connect the battery to this connector.

## Antenna locations

The following illustration shows the antenna locations.

### ThinkPad T14s Gen 7

Type 1

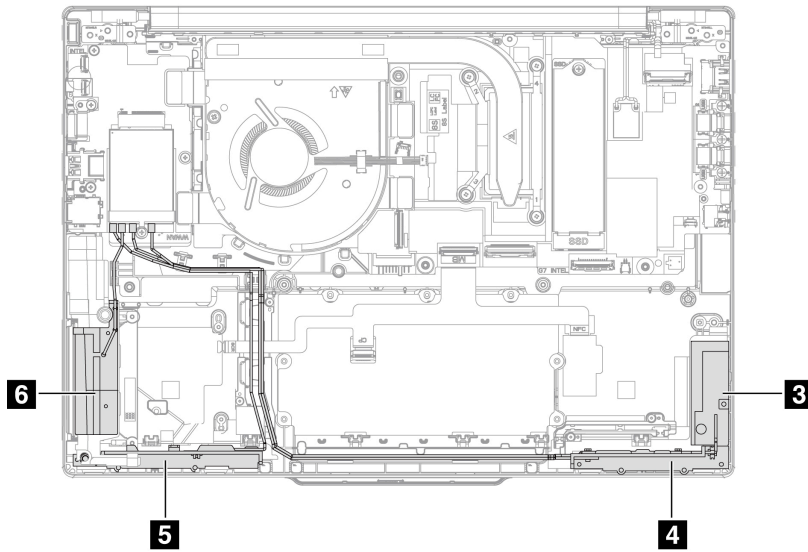
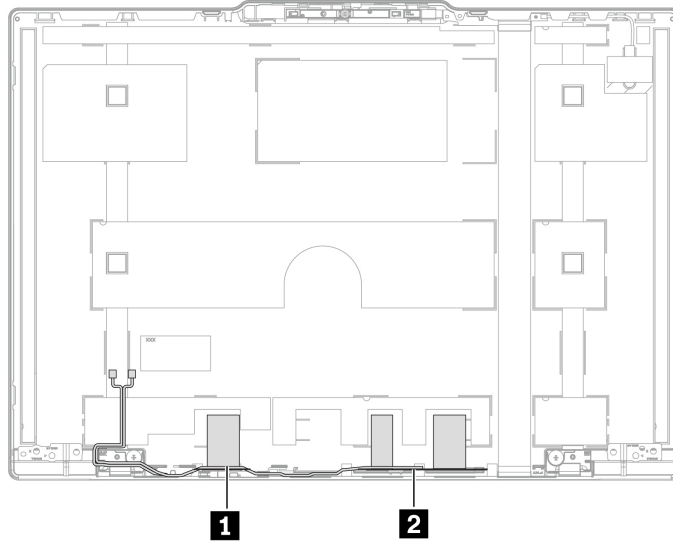

- 1** Wireless LAN antenna (main)
- 2** Wireless LAN antenna (auxiliary)
- 3** Wireless WAN antenna (MIMO2)\*
- 4** Wireless WAN antenna (auxiliary)\*
- 5** Wireless WAN antenna (main)\*
- 6** Wireless WAN antenna (MIMO1)\*

\* for selected models

Type 2

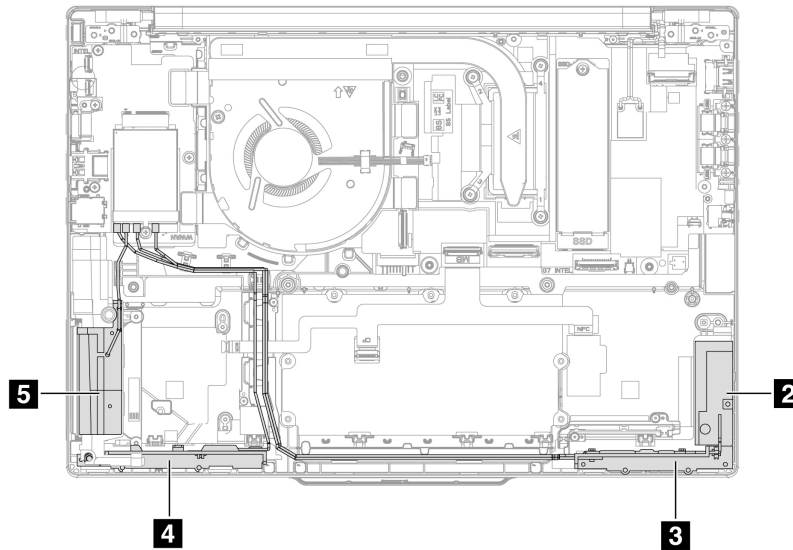
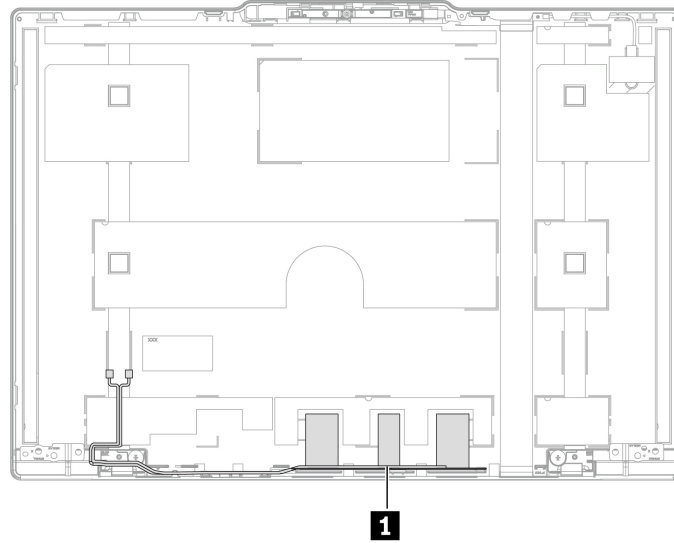

- 1** Wireless LAN antenna (main&auxiliary)
- 2** Wireless WAN antenna (MIMO2)\*
- 3** Wireless WAN antenna (auxiliary)\*
- 4** Wireless WAN antenna (main)\*
- 5** Wireless WAN antenna (MIMO1)\*

\* for selected models

**ThinkPad T14s 2-in-1 Gen 2**

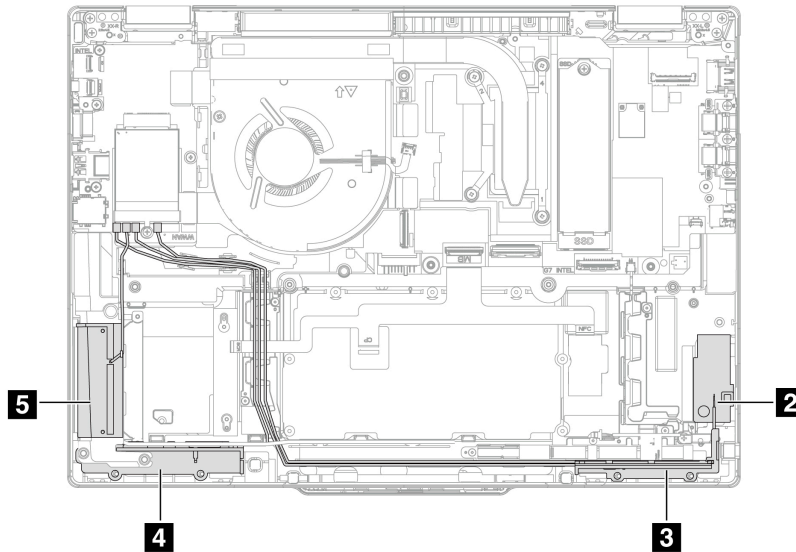
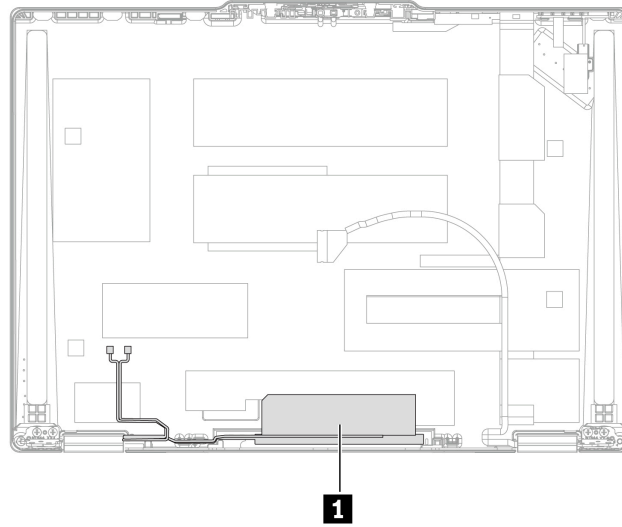

- 1** Wireless LAN antenna (main&auxiliary)
- 2** Wireless WAN antenna (MIMO2)\*
- 3** Wireless WAN antenna (auxiliary)\*
- 4** Wireless WAN antenna (main)\*
- 5** Wireless WAN antenna (MIMO1)\*

\* for selected models

## Replacement videos

You can refer to CRU/FRU replacement videos for Lenovo authorized service technicians in the following support site:

ThinkPad T14s Gen 7	<a href="https://go.lenovo.com/thinkpadt14sgen7fruvideos">https://go.lenovo.com/thinkpadt14sgen7fruvideos</a>
ThinkPad T14s 2-in-1 gen 2	<a href="https://go.lenovo.com/thinkpadt14s-2-in-1gen2fruvideos">https://go.lenovo.com/thinkpadt14s-2-in-1gen2fruvideos</a>

---

## Chapter 5. Hardware replacement

This chapter provides instructions on how to remove and install the hardware components of your computer.

---

### Before hardware replacement

Before replacing any FRU/CRU, ensure that you have read this section and complete all required steps.

### General prerequisites and guidelines



**Before removing any CRU/FRU, turn off the computer, unplug all power cords from electrical outlets, disable the built-in battery, and then disconnect any interconnecting cables.**

When removing or installing a CRU/FRU, be sure to observe the following general guidelines and strategies:

1. Before replacing any CRU/FRU, ensure that you have read [Generic Safety and Compliance Notices](#) and safety requirements for hardware maintenance in this manual.
2. Before replacing any CRU/FRU listed in this manual, ensure that all software fixes, drivers, and UEFI BIOS downloads are installed. To download software fixes, drivers, and UEFI BIOS, go to <https://support.lenovo.com> and follow the instructions on the screen.
3. Use the following strategies to prevent unnecessary expense for replacing and servicing CRUs/FRUs:
  - If you are instructed to replace a CRU/FRU but the replacement does not correct the problem, reinstall the original CRU/FRU before you continue.
  - Some computers have both a processor board and a system board. If you are instructed to replace either the processor board or the system board, and replacing one of them does not correct the problem, reinstall that board, and then replace the other one.
  - If an adapter or a device consists of more than one CRU/FRU, any of the CRU/FRU may be the cause of the error. Before replacing the adapter or device, remove the CRUs/FRUs one by one to see if the symptoms change. Replace only the CRU/FRU that changed the symptoms.
4. Before replacing any CRU/FRU, review Chapter 4 “Reference information for hardware replacement” on page 44.
5. Begin by removing any CRUs/FRUs that have to be removed before replacing the failing CRU/FRU. Any such CRUs/FRUs are listed at the beginning of each CRU/FRU replacement section. Remove them in the order in which they are listed.
6. Follow the correct sequence in the steps for removing or installing a CRU/FRU, as given in the illustrations by the numbers in square callouts.
7. When removing a CRU/FRU, move it in the direction as given by the arrow in the illustration.

#### Attention:

- The system board is sensitive to and can be damaged by ESD. Before touching it, establish personal grounding by touching a ground point with one hand or by using an ESD strap.
- After replacing a CRU/FRU, do not turn on the computer until you have made sure that all screws, springs, and other small parts are in place and none are loose inside the computer. Verify this by shaking the computer gently and listening for rattling sounds. Metallic parts or metal flakes can cause electrical short circuits.

## Prerequisites for opening the base cover

Before you open the base cover, make sure to:

- Turn off the computer
- Disconnect the computer from ac power and all connected cables
- Close the display and turn the computer over
- Disable Fast Startup and the built-in battery as guided by “Disable Fast Startup and the built-in battery” on page 60
- Remove the nano-SIM card and nano-SIM-card tray, if any, as guided by “Remove the nano-SIM card and nano-SIM-card tray (for selected models)” on page 60

**Important:** There might be a risk of short circuits if you remove the base cover when:

- The computer has a removable battery installed
- The computer is still connected to AC power

## Disable Fast Startup and the built-in battery

### To disable Fast Startup

- Step 1. Go to Control Panel and view by Large icons or Small icons.
- Step 2. Click **Power Options**, and then click **Choose what the power buttons do** on the left pane.
- Step 3. Click **Change settings that are currently unavailable** at the top.
- Step 4. If prompted by User Account Control (UAC), click **Yes**.
- Step 5. Clear the **Turn on fast startup** check box, and then click **Save changes**.

### To disable the built-in battery

- Step 1. Restart your computer. When the logo screen is displayed, immediately press F1 to enter the UEFI BIOS menu.
- Step 2. Select **Config** → **Power**. The **Power** submenu is displayed.
- Step 3. Select **Disable built-in battery** and press Enter.
- Step 4. Select **Yes** in the Setup Confirmation window.

The built-in battery is disabled and the computer turns off automatically. Wait three to five minutes to let the computer cool.

**Notes:** If your computer cannot enter the UEFI BIOS menu, you cannot disable the built-in battery. To avoid short circuit when you replace a part, it is recommended to do the following:

- For the built-in battery connected to the system board with cables: Disconnect the battery cables.
- For the built-in battery connected to the system board with combo connectors: Disconnect the connectors by removing the battery. For the removal procedure, refer to the built-in battery replacement instructions in this documentation.

## Remove the nano-SIM card and nano-SIM-card tray (for selected models)

If the computer you are servicing has a nano-SIM card installed, remove the card with the tray together.

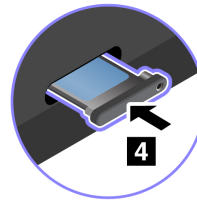
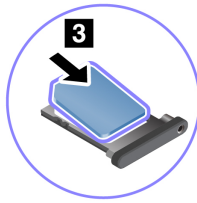
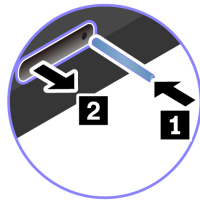

---

## Base cover assembly

### Prerequisites

- Before you start, ensure that you have read “Before hardware replacement” on page 59 and complete all required steps.
- Tools needed: Philips head screwdriver

### Replacement steps

Step 1. Remove the base cover assembly as shown below.

**When you loosen screw 1a, a gap appears and you can use the gap to lift up the base cover assembly.**

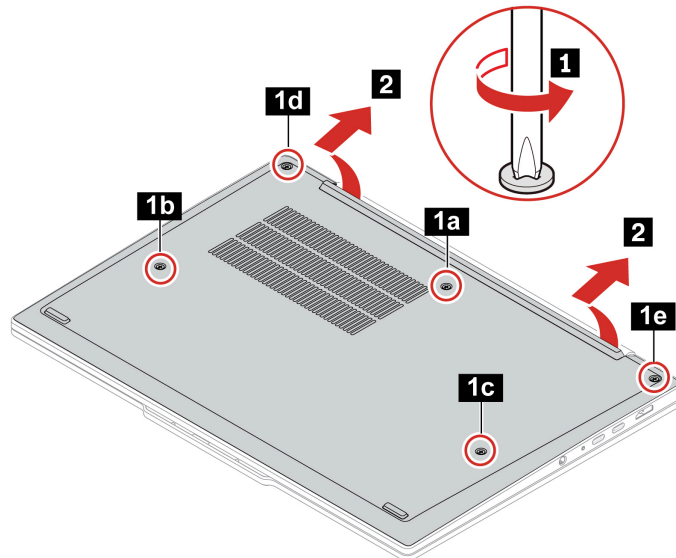

Step 2. Install the base cover as shown below.

**When you tighten the screw 1a, the gap will be closed. Do not push down the screw 1a, otherwise it might get damaged.**

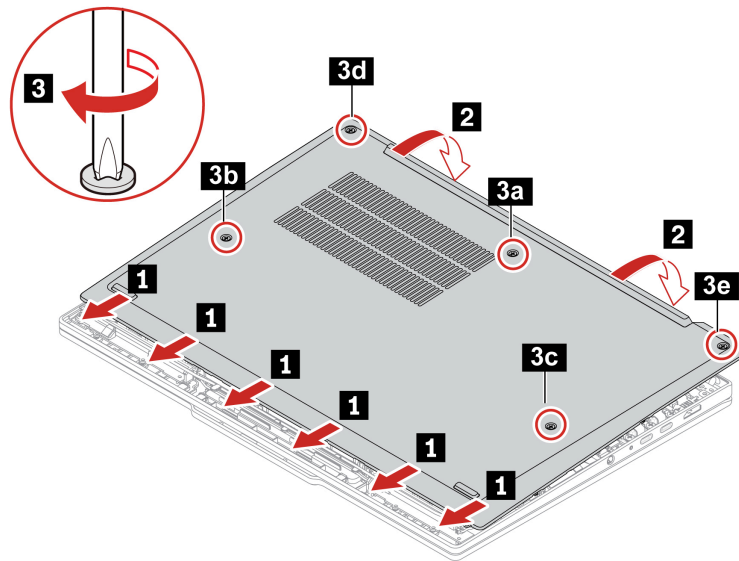

**Note:** If the computer does not start up after you reinstall the base cover, disconnect the ac power adapter and then reconnect it to the computer.

## Apply labels to the base cover assembly

### Notes:

- Depending on the country or region of delivery, the labels might be slightly different from the ones in the following illustration.
- Apply the labels in the label kit when you replace the base cover assembly. For the labels that are not contained in the label kit, peel them from the old base cover assembly, and adhere them to the new one.
- As service QR code is unique to each computer, it is suggested to take a picture of it on the base cover assembly to get product information or help from Lenovo support.

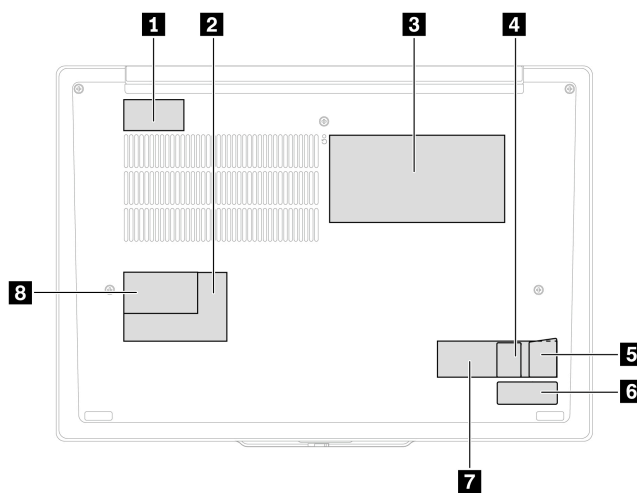

## Item

- 1 IMEI label GEO label
- 3 Asset tag
- 5 Genuine Microsoft label
- 7 COA label

## Item

- 2 Country label
- 4 Service QR code
- 6 S/N label
- 8 SVT label

---

## M.2 solid-state drive and M.2 solid-state drive bracket

### Prerequisites

- Before you start, ensure that you have read “Before hardware replacement” on page 59 and complete all required steps.
- The M.2 solid-state drive is sensitive. Inappropriate handling might cause damage and permanent loss of data. When handling the M.2 solid-state drive, observe the following guidelines:
  - Remove or insert the M.2 solid-state drive horizontally. Otherwise the slot might get damaged.

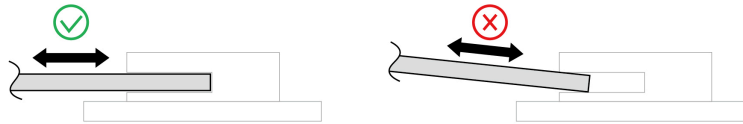

- Replace the M.2 solid-state drive only for repair. The M.2 solid-state drive is not designed for frequent changes or replacement.
  - Before replacing the M.2 solid-state drive, make a backup copy of all the data that you want to keep.
  - Do not apply pressure to the M.2 solid-state drive.
  - Do not touch the contact edge or circuit board of the M.2 solid-state drive. Otherwise, the M.2 solid-state drive might get damaged.
  - Do not subject the M.2 solid-state drive to physical shocks or vibration. Put the M.2 solid-state drive on a soft material, such as cloth, to absorb physical shocks.
- Tool needed: Phillips head screwdriver

### Attention:

- Always try to run a low-level format operation before replacing an M.2 solid-state drive. This will erase all data on the drive. Ensure that the customer has a current backup of the data before you perform this task.
- The drive startup sequence in the computer you are servicing might have been changed. Be extremely careful during write operations such as copying, saving, or formatting. If you select an incorrect drive, data or programs can be overwritten.
- If you replace an M.2 solid-state drive, you might need to install a new operating system. For details on how to install a new operating system, see “Install, upgrade, and recover operating system” on page 123.
- Your computer only supports single-sided M.2 solid-state drive. Double-sided M.2 solid-state drive is not applicable due to the height limitation of the slot.

## Type 1

### Replacement steps

Step 1. Remove the “Base cover assembly” on page 61.

Step 2. Loosen the one captive screw and remove the M.2 solid-state drive bracket and M.2 solid-state drive as shown below.

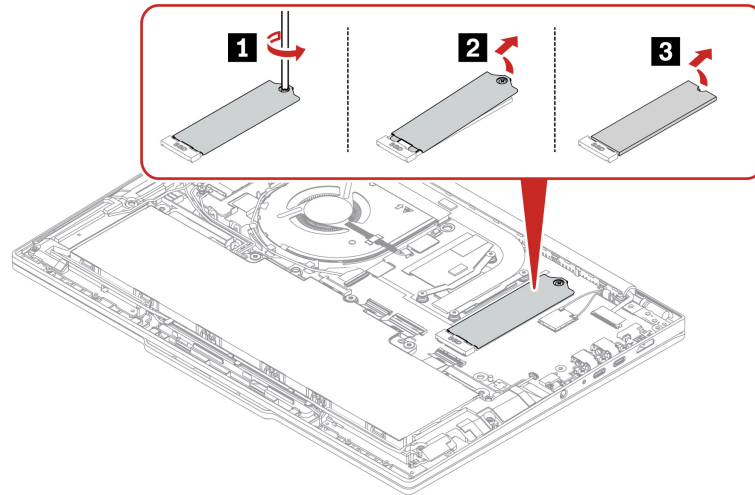

Step 3. Install the M.2 solid-state drive and M.2 solid-state drive bracket in reverse order.

**Note:** If the SSD thermal pad between SSD and system board is removed, make sure re-attach it and make sure the sticky side is placed on system board.

## Type 2

### Replacement steps

Step 1. Remove the “Base cover assembly” on page 61.

Step 2. Loosen the one captive screw and remove the M.2 solid-state drive bracket and M.2 solid-state drive as shown below.

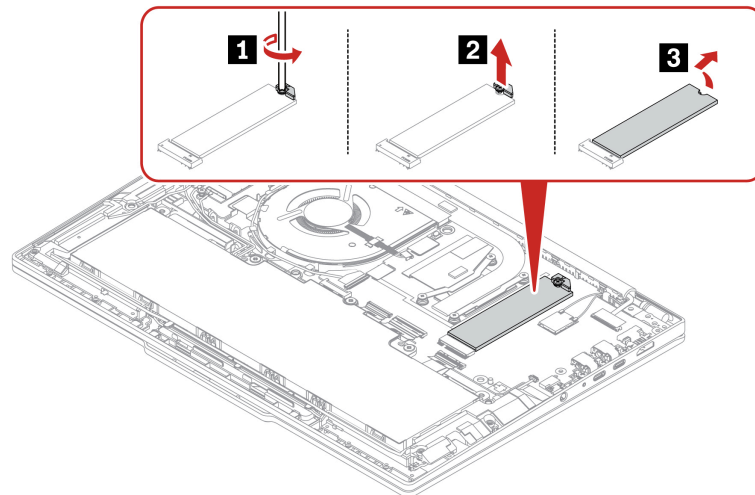

Step 3. Install the M.2 solid-state drive and M.2 solid-state drive bracket in reverse order.

**Note:** If the SSD thermal pad between SSD and system board is removed, make sure re-attach it and make sure the sticky side is placed on system board.

---

## Wireless WAN module and wireless WAN module bracket (for selected models)

Follow the instructions to replace the Wireless WAN module and WAN module bracket.

The following information is only for the computer with user-installable modules. Ensure that you use only a Lenovo-authorized wireless module specifically tested for this computer model. Otherwise, the computer will generate an error-code beep sequence when you turn on the computer.

### Notes:

- Wireless WAN ready model identifies that product has preinstalled wireless WAN antennas and allows a user-installable wireless WAN module.
- Only wireless WAN model or wireless WAN ready model is allowed to install the optional Lenovo wireless WAN module.

### Prerequisites

- Before you start, ensure that you have read “Before hardware replacement” on page 59 and complete all required steps.
- Tool needed: Phillips head screwdriver

## 5G models

### Replacement steps

Step 1. Remove the “Base cover assembly” on page 61.

Step 2. Remove the wireless WAN module and its bracket as shown below.

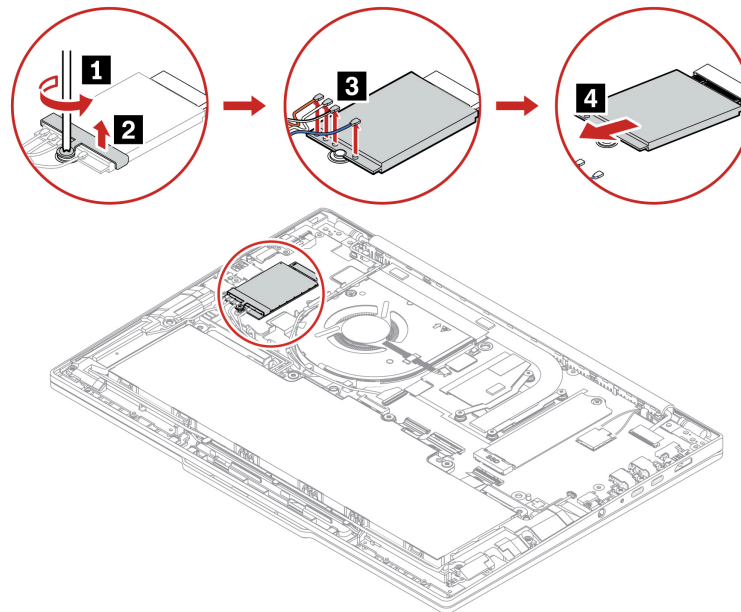

Step 3. Install the wireless WAN module and its bracket in reverse order.

## 4G models

### Replacement steps

Step 1. Remove the “Base cover assembly” on page 61.

Step 2. Remove the wireless WAN module and its bracket as shown below.

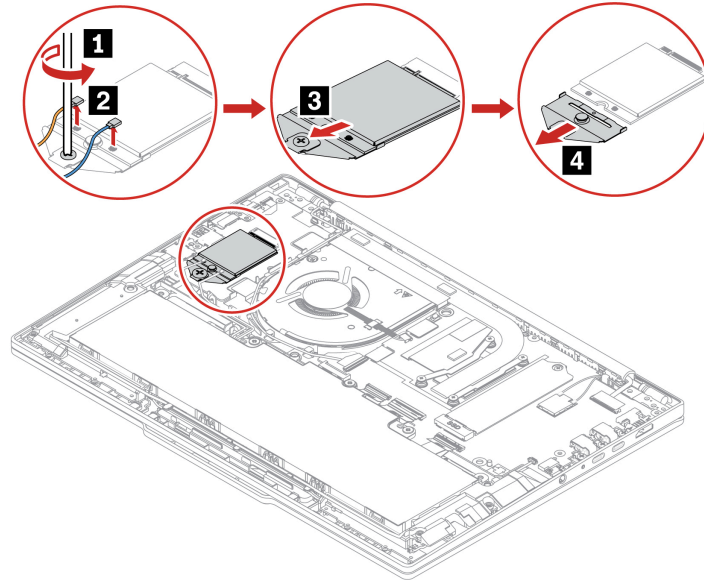

Step 3. Install the wireless WAN module and its bracket in reverse order.

**Note:** During installation, ensure that you connect the cables with different colors to the corresponding connectors on the module according to the illustrations above: the orange cable to the connector labeled ORANGE, the blue cable to the connector labeled BLUE, the white and grey cable to the connector labeled WHITE GREY, and the black and grey cable to the connector labeled BLACK GREY.

## Dummy wireless WAN module and wireless WAN module bracket

### Replacement steps

Step 1. Remove the “Base cover assembly” on page 61.

Step 2. Remove the wireless WAN module and its bracket as shown below.

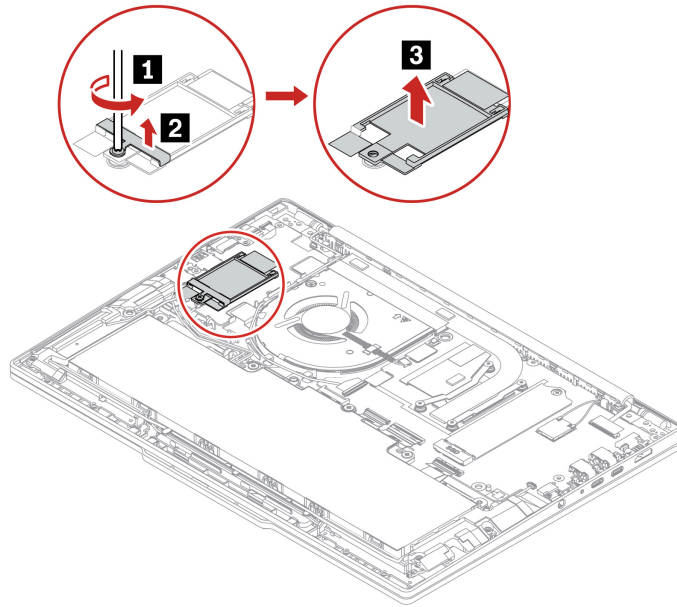

Step 3. Install the dummy wireless WAN module and its bracket in reverse order.

---

## Replaceable USB-C module and replaceable USB-C module bracket

Follow the instructions to replace the replaceable USB-C module and replaceable USB-C module bracket.

### Prerequisites

- Before you start, ensure that you have read “Before hardware replacement” on page 59 and complete all required steps.
- Tool needed: Phillips head screwdriver

Step 1. Remove the “Base cover assembly” on page 61.

Step 2. Remove the replaceable USB-C module and its bracket as shown below:

- Remove the screws and the replaceable USB-C bracket.

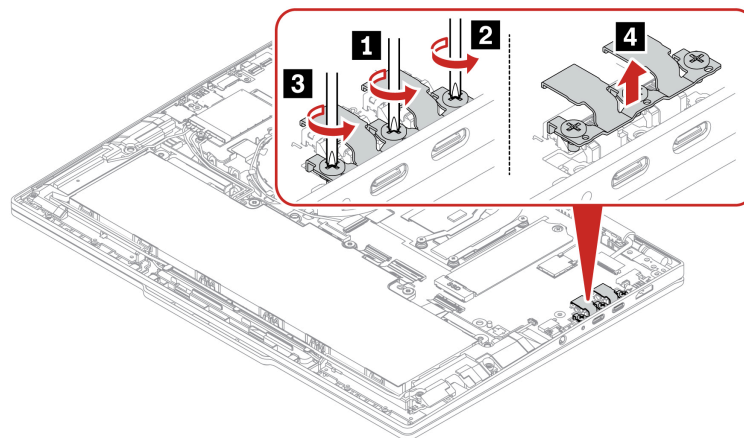

- b. Slide the replaceable USB-C module inward until it tilts up, and then remove it. When removing the replaceable USB-C module, remove the one marked 2 first.

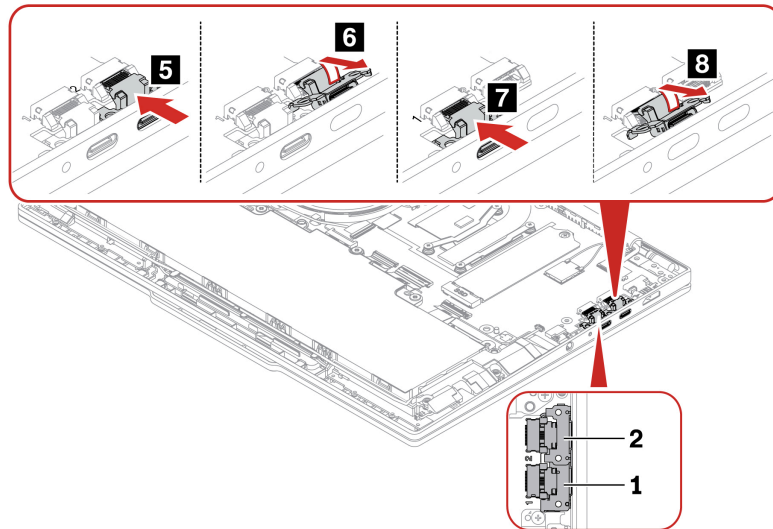

Step 3. Install the replaceable USB-C module and its bracket as shown below.

- a. Firstly, tilt the replaceable USB-C module and insert it into the connector. Secondly, press down the replaceable USB-C module and then slide it outward until it aligns with the screw hole. When installing the modules, install the one marked 1 first.

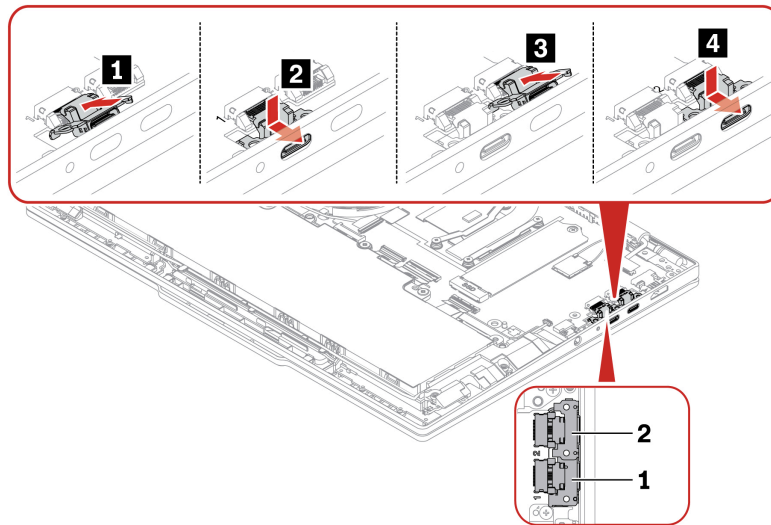

- b. Place the replaceable USB-C module bracket in position and then tighten the screws to fix the replaceable USB-C module.

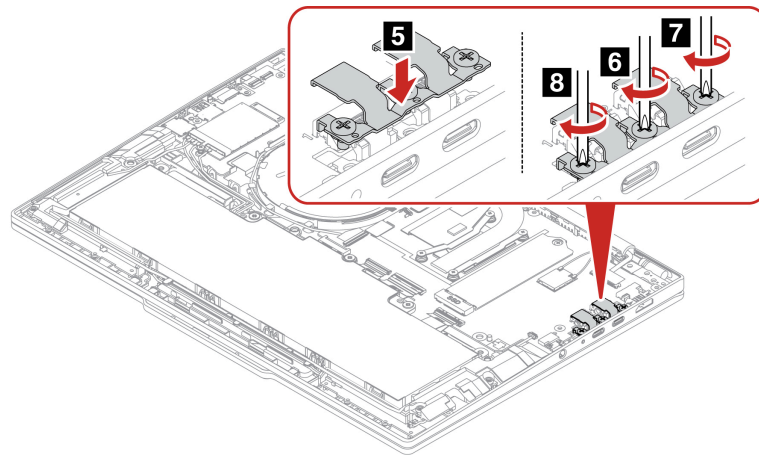

---

## Built-in battery

### Prerequisites

- Before you start, ensure that you have read “Before hardware replacement” on page 59 and complete all required steps.
- Lenovo recommends you use a qualified repair technician or ensure that you carefully follow all instructions provided by Lenovo. The Lenovo-authorized repair facilities or technicians recycle Lenovo batteries according to local laws and regulations. Please do not dispose of your battery with your household waste. For recycling information go to <https://www.lenovo.com/recycling>.

**Attention:** Lenovo has no responsibility for the performance or safety of unauthorized batteries, and provides no warranties for failures or damage arising out of their use.

- The Vantage app provides an automatic battery diagnostics test that determines if the built-in battery is defective. A built-in battery should not be replaced unless this diagnostics test shows that the battery is defective. The only exception to this is if the built-in battery is physically damaged or a customer is reporting a possible safety issue.

If the Vantage app is not installed on the computer, the customer should download and install the application to diagnose the built-in battery, before replacing a non-physically damaged built-in battery. Note that the replacement of a physically damaged built-in battery is not covered by the warranty.

- Tools needed: Phillips head screwdriver

### CAUTION:

**Use only the Lenovo-authorized battery specified for the computer. Any other battery could ignite or explode.**

**Batteries supplied by Lenovo for use with your product have been tested for compatibility and should only be replaced with approved parts. A battery other than the one specified by Lenovo, or a disassembled or modified battery may not be covered by warranty.**

**Battery abuse or mishandling can cause overheating, liquid leakage, or an explosion. To avoid possible injury:**

- **Do not open, disassemble or service any battery unless you are competent to do so and ensure that you carefully follow all instructions provided by Lenovo.**
- **Do not crush or puncture the battery.**

- Do not short-circuit the battery, or expose it to water or other liquids.
- Keep the battery away from children.
- Keep the battery away from fire.
- Stop using the battery if it is damaged, or if you notice any discharge or the buildup of foreign materials on the battery leads.
- Store the rechargeable batteries or products containing the rechargeable batteries at room temperature, charged to approximately 30 to 50% of capacity. We recommend that the batteries be charged about once per year to prevent overdischarge.
- Do not put the battery in trash that is disposed of in landfills. When disposing of the battery, comply with local ordinances or regulations.
- If the battery is incorrectly replaced, there is danger of an explosion. The battery contains a small amount of harmful substances.

### Replacement steps

Step 1. Remove the “Base cover assembly” on page 61.

Step 2. Remove the built-in battery as shown below.

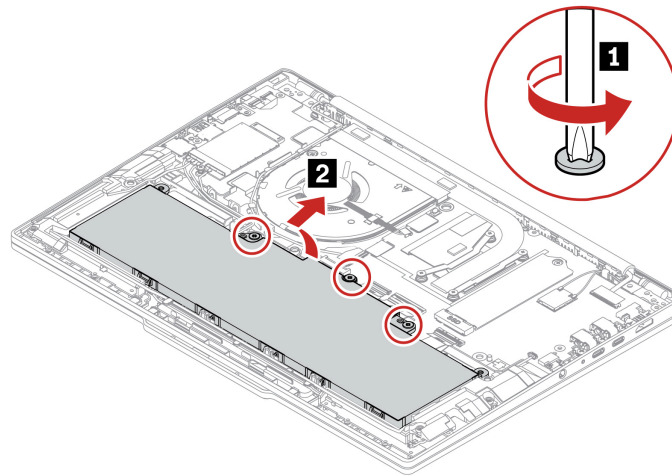

Step 3. Before installing the built-in battery, thoroughly check the battery compartment and ensure that there are no foreign or sharp objects that could cause damage to the battery.

Step 4. Install the built-in battery in reverse order.

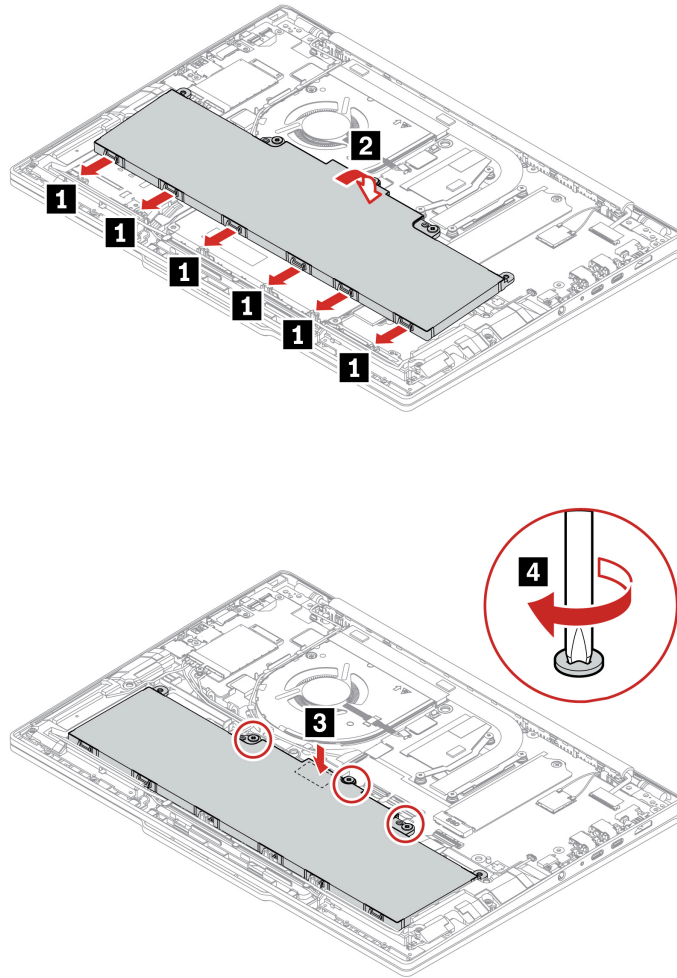

**Note:** When installing: ensure that the base cover assembly is secured in place. Otherwise, the battery connection might fail.

---

## Thermal fan assembly

### Prerequisites

- Before you start, ensure that you have read “Before hardware replacement” on page 59 and complete all required steps.
- Tool needed: Phillips head screwdriver

### Replacement steps

Step 1. Remove the “Base cover assembly” on page 61.

Step 2. Disconnect the fan assembly cables from the system board as shown below.

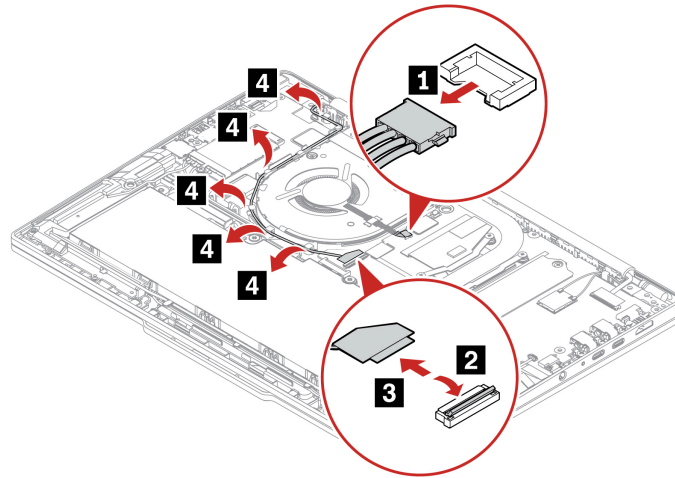

Step 3. Loosen the five captive screws and remove the fan assembly as shown below.

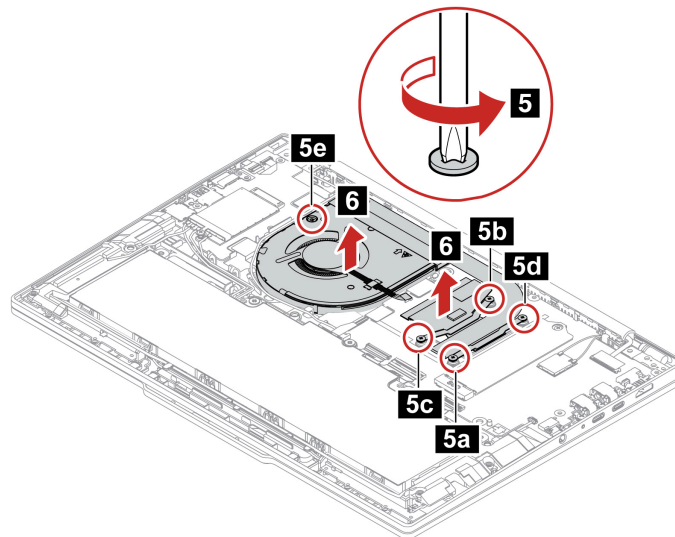

Step 4. Install the fan assembly in reverse order.

**When installing:**

- Do not press the top of the fan cover and the fan hub.
- If you are installing back the same thermal fan assembly you have removed (not installing a new one), before you attach the assembly to the computer:
  - For **a** area :
    - Grease type : Clean all thermal grease that have been used and then apply new thermal grease. Apply new thermal grease (Honeywell PTM 795L or PTM 7958) at an amount of 0.2 grams, on the parts marked **a** as shown in the following illustration. Either too much or too less application of grease can cause a thermal problem due to imperfect contact with a component.

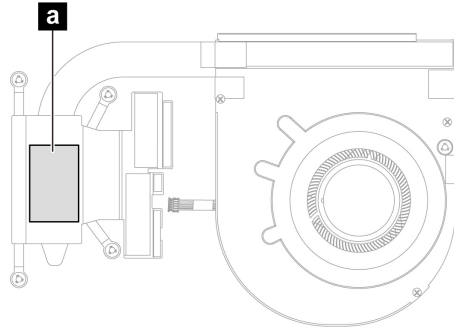

- Sheet type : Apply Honeywell PTM 795L or PTM 7958 sheet type at the size as following instructions. Either too much or too less application of Sheet type can cause a thermal problem due to imperfect contact with a component.

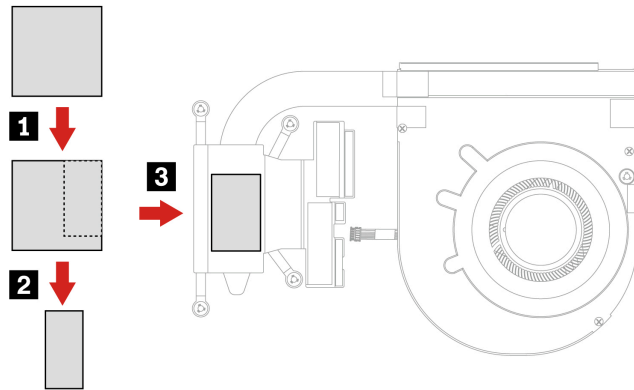

	CPU	
	X(mm)	Y(mm)
Die Size(example)	16	12
Fru Cutting Size	18	14

- For **b** area : Ensure the area with thermal pad are attached firmly before reinstallation.

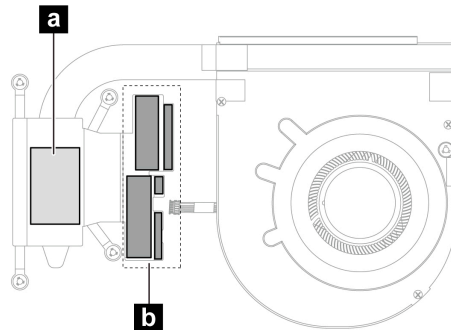

- Tighten the screws in ascending order by following the alphabet marked beside each screw. Otherwise, the system board might get damaged.
- Ensure that the connector is attached firmly.

---

## Speaker assembly and wireless WAN MIMO antenna kits

### Prerequisites

Before you start, ensure that you have read “Before hardware replacement” on page 59 and complete all required steps.

### Replacement steps

Step 1. Remove the following parts in order.

- “Base cover assembly” on page 61
- “Built-in battery” on page 69

Step 2. Remove the speaker assembly and wireless WAN MIMO antenna as shown below.

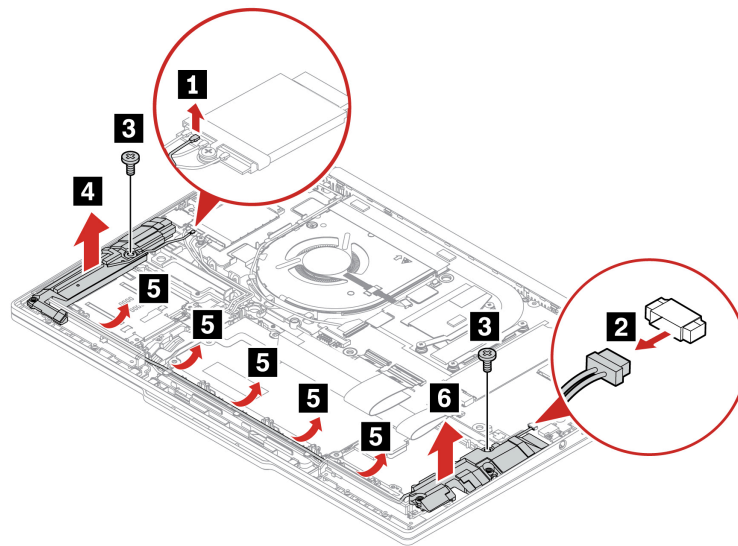

**Note:** Some models do not have MIMO antennas.

Step	Thread(mm)	Length (mm)	Torque	Quantity
<b>3</b>	M1.6	2.1	0.1±0.015 N·m (1.1 ±0.15 kgf·cm)	2

Step 3. Install the speaker assembly and wireless WAN MIMO antenna in reverse order.

**Notes:** When installing:

- Ensure that the connector is attached firmly.
- Ensure that cables are routed without being subject to any tension. Tension could cause the cables to be damaged by the cable guides, or a wire to be broken.

---

## Wireless WAN antenna assembly (for selected models)

### Prerequisites

Before you start, ensure that you have read “Before hardware replacement” on page 59 and complete all required steps.

Step 1. Remove the following parts in order.

- “Base cover assembly” on page 61
- “Built-in battery” on page 69
- “Speaker assembly and wireless WAN MIMO antenna kits” on page 74

Step 2. Remove the wireless WAN antenna assembly as shown below.

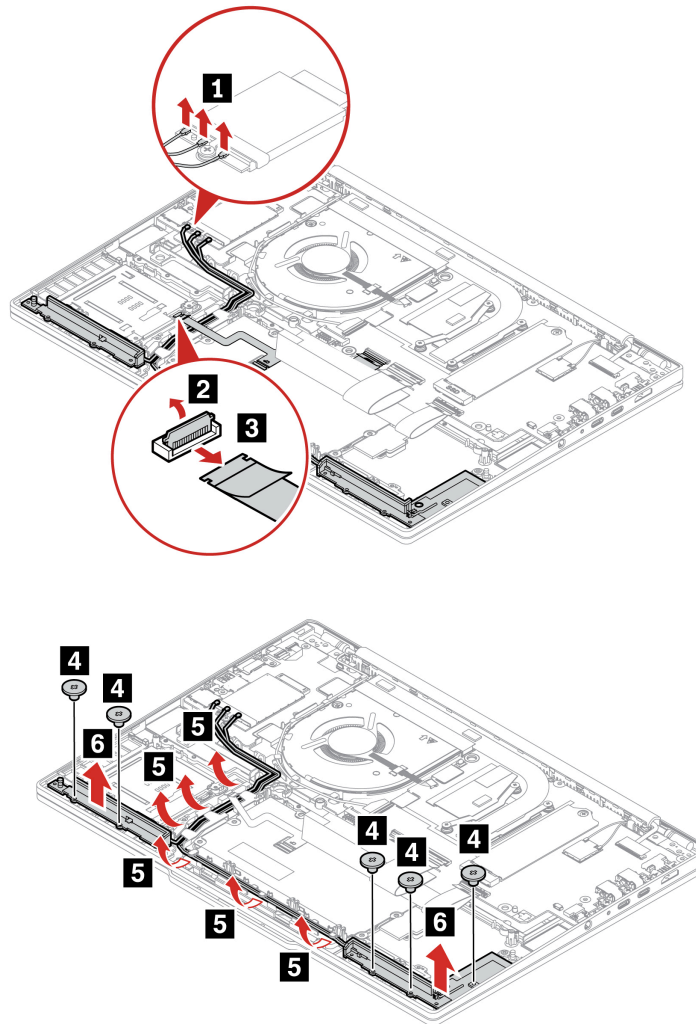

Step	Thread (mm)	Length (mm)	Torque	Quantity
<b>4</b> (ThinkPad T14s Gen 7)	M1.6	2.6	0.1±0.015 N·m (1.1 ±0.15 kgf·cm)	5
<b>4</b> ( ThinkPad T14s 2-in-1 Gen 2 )	M1.6	2.1	0.1±0.015 N·m (1.1 ±0.15 kgf·cm)	5

Step 3. Install the wireless WAN antenna assembly in reverse order.

**Notes:** When installing:

- Ensure that the connector is attached firmly.
- Ensure that cables are routed without being subject to any tension. Tension could cause the cables to be damaged by the cable guides, or a wire to be broken.

---

## Lenovo Integrated Pen (for selected 2-in-1 models)

### Replacement steps

Step 1. Close the computer display and turn the computer over.

Step 2. Remove the Lenovo Integrated Pen as shown below.

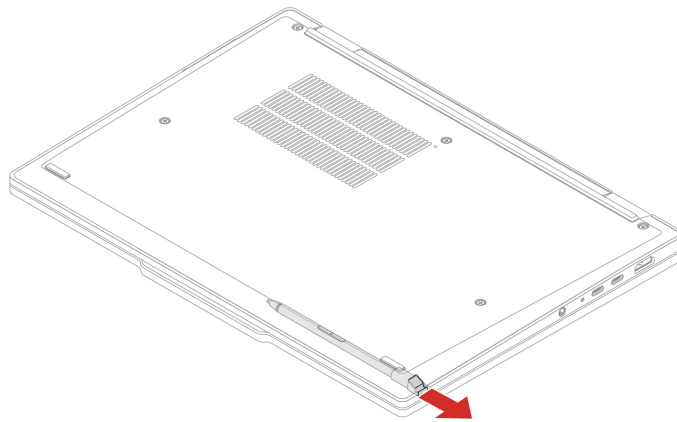

Step 3. Install the Lenovo Integrated Pen in reverse order.

---

## Dummy Pen (for selected 2-in-1 models)

### Prerequisites

Before you start, ensure that you have read “Before hardware replacement” on page 59 and complete all required steps.

### Replacement steps

Step 1. Remove the “Base cover assembly” on page 61.

Step 2. Remove the dummy pen as shown below.

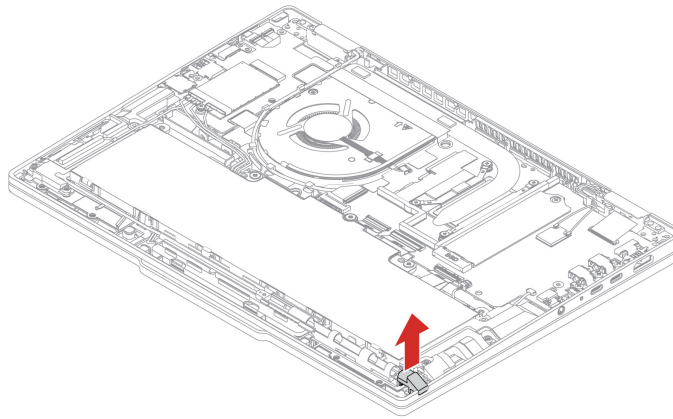

Step 3. Install the dummy pen in reverse order.

---

## Pen charge cable(for selected 2-in-1 models)

### Prerequisites

Before you start, ensure that you have read “Before hardware replacement” on page 59 and complete all required steps.

### Replacement steps

Step 1. Remove the following parts in order:

- “Base cover assembly” on page 61
- “Built-in battery” on page 69
- “Speaker assembly and wireless WAN MIMO antenna kits” on page 74

Step 2. Remove the pen charge cable as shown below.

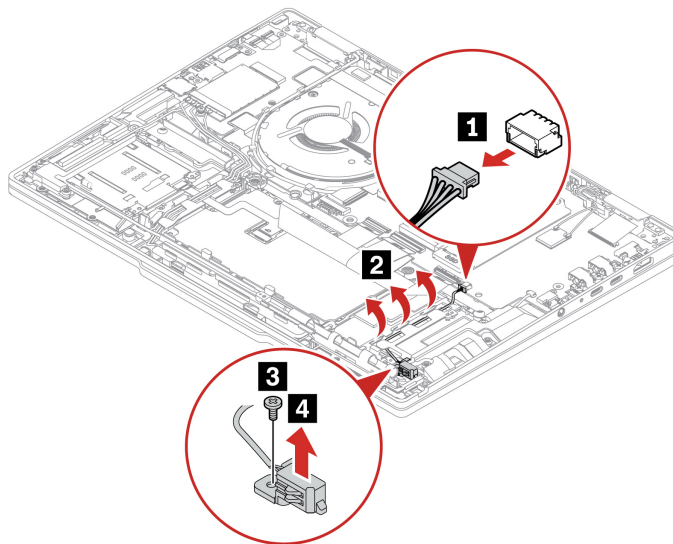

Step 3. Install the Pen charge cable in reverse order.

Step	Thread(mm)	Length (mm)	Torque	Quantity
<b>3</b>	M1.6	2.1	0.1±0.015 N·m (1.1 ±0.15 kgf·cm)	1

---

## NFC module (for selected models)

### Prerequisites

Before you start, ensure that you have read “Before hardware replacement” on page 59 and complete all required steps.

### Replacement steps

Step 1. Remove the following parts in order:

- “Base cover assembly” on page 61
- “Built-in battery” on page 69

Step 2. Remove the NFC module as shown below.

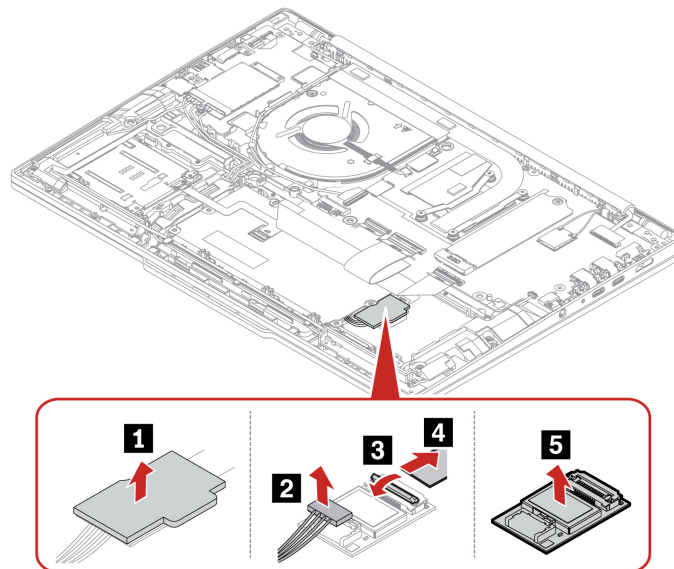

Step 3. Install the NFC module in reverse order.

---

## Smart card reader and audio smart card sponge (for selected models)

### Prerequisites

Before you start, ensure that you have read “Before hardware replacement” on page 59 and complete all required steps.

### Replacement steps

Step 1. Remove the following parts in order:

- “Base cover assembly” on page 61
- “Built-in battery” on page 69
- “Speaker assembly and wireless WAN MIMO antenna kits” on page 74
- “Wireless WAN antenna assembly (for selected models)” on page 74

Step 2. Remove the smart card reader as shown below.

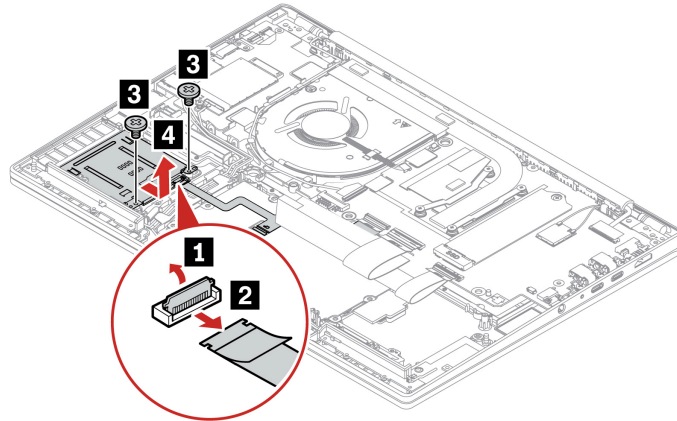

Step	Thread(mm)	Length (mm)	Torque	Quantity
<b>3</b>	M1.6	2.1	0.1±0.015·N·m (1.1 ±0.15 kgf·cm)	2

Step 3. Install the smart card reader in reverse order.

Before installing, attach the audio smart card sponge at the marked position.

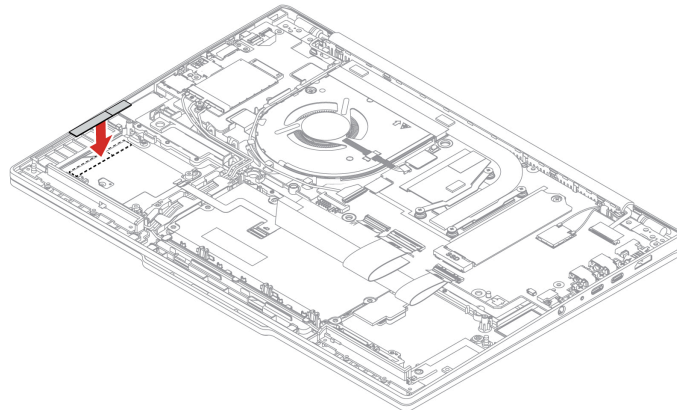

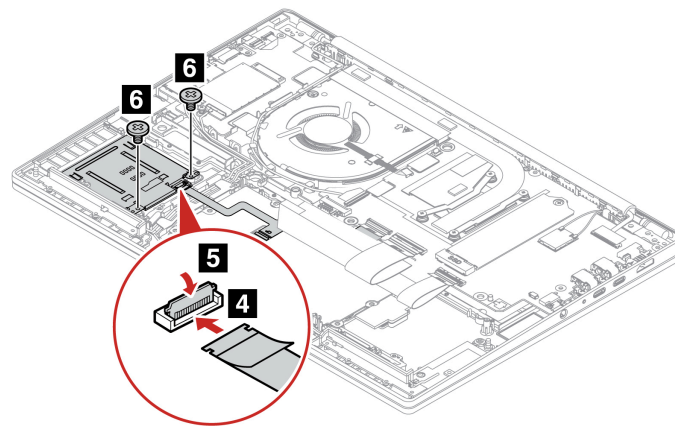
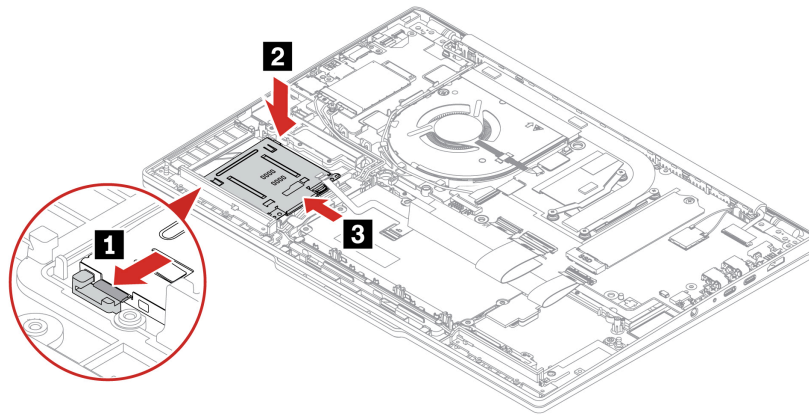

---

## Dummy smart card (for selected models)

### Prerequisites

Before you start, ensure that you have read “Before hardware replacement” on page 59 and complete all required steps.

### Replacement steps

Step 1. Remove the following parts in order:

- “Base cover assembly” on page 61
- “Built-in battery” on page 69
- “Speaker assembly and wireless WAN MIMO antenna kits” on page 74
- “Wireless WAN antenna assembly (for selected models)” on page 74

Step 2. Remove the dummy smart card as shown below.

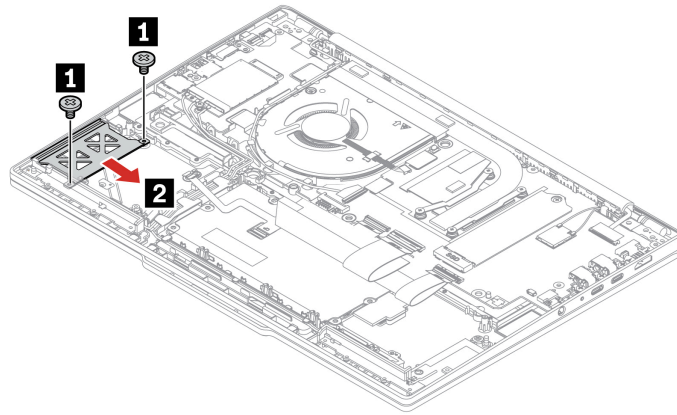

Step	Thread (mm)	Length (mm)	Torque (kgf.cm)	Quantity
<b>1</b>	M1.6	2.1	0.1±0.015 N·m (1.1 ±0.15 kgf·cm)	2

Step 3. Install the dummy smart card in reverse order.

---

## Smart card reader-Trackpad-NFC cable (for selected models)

### Prerequisites

Before you start, ensure that you have read “Before hardware replacement” on page 59 and complete all required steps.

### Replacement steps

Step 1. Remove the following parts in order.

- “Base cover assembly” on page 61
- “Built-in battery” on page 69

Step 2. Remove the smart card reader-Trackpad-NFC cable as shown below.

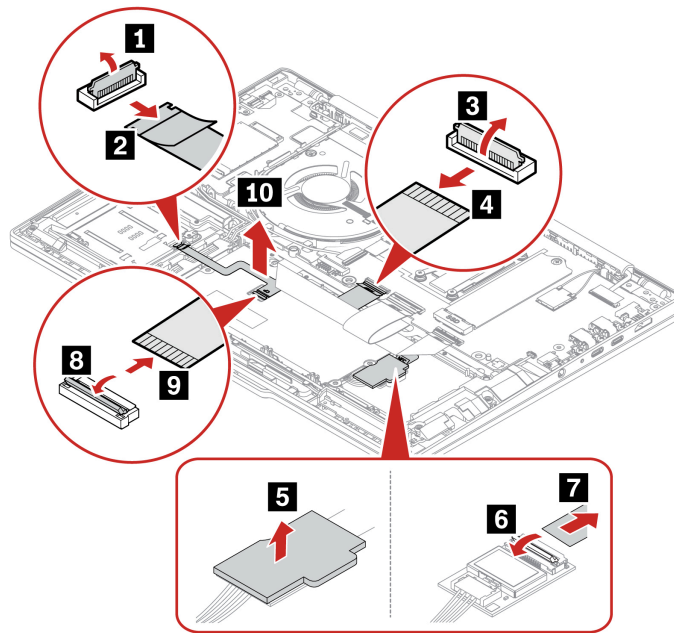

Step 3. Install the smart card reader-Trackpad-NFC cable in reverse order. When installing, ensure that the connectors are attached firmly.

**Note:** To prevent noise caused by cable movement, please attach the original tape to the marked **a** position after installation. If it is damaged, you can also use painter's tape (masking tape) instead.

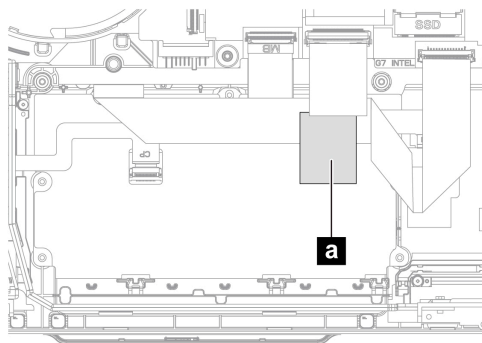

## Display unit (ThinkPad T14s Gen 7)

### Prerequisites

- Before you start, ensure that you have read “Before hardware replacement” on page 59 and complete all required steps.
- Tool needed: Phillips head screwdriver

### Replacement steps

Step 1. Remove the “Base cover assembly” on page 61.

Step 2. Remove the display unit as shown below.

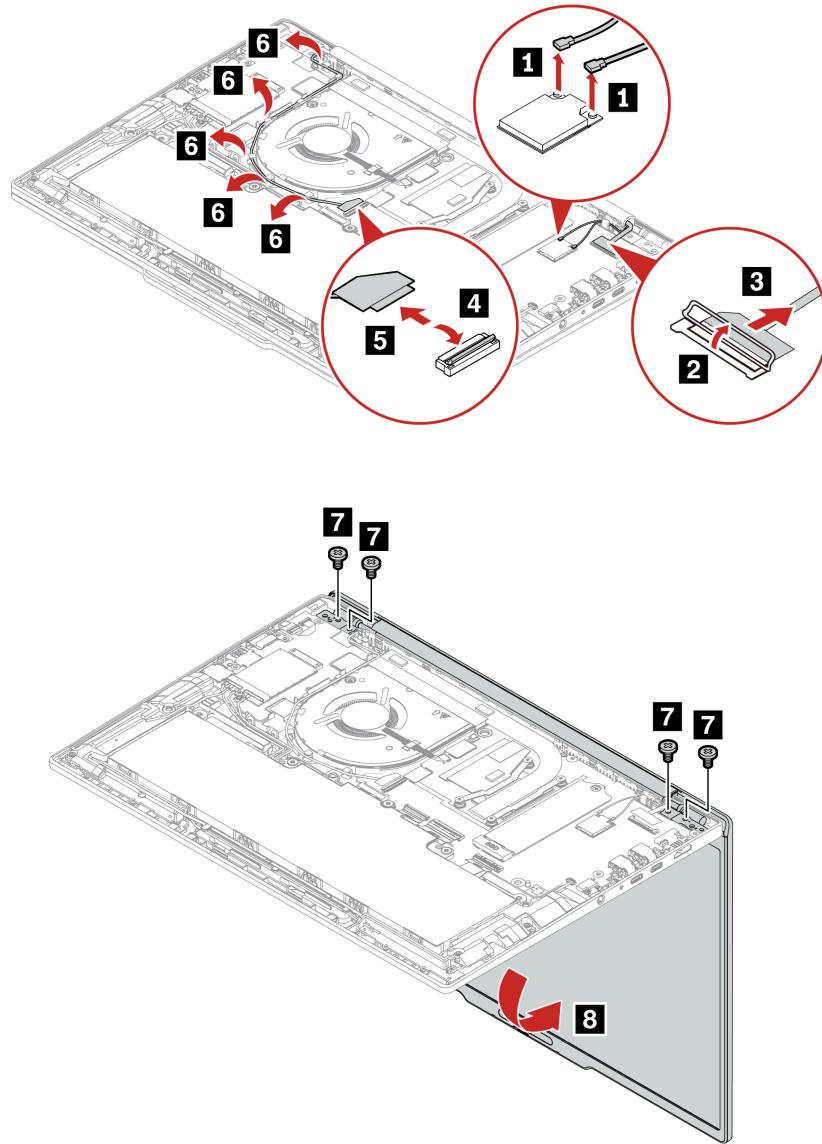

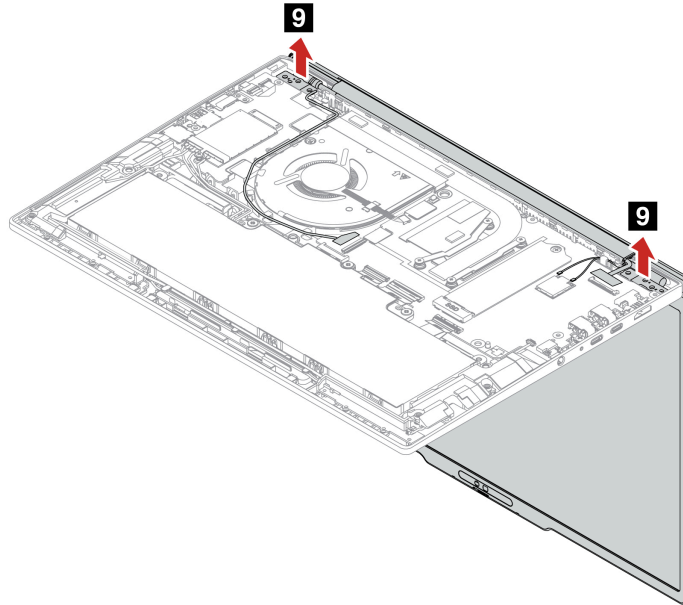

**Note:** For OLED SKU, display unit is a single FRU.

Step	Thread (mm)	Length (mm)	Torque	Quantity
<b>7</b>	M2.5	4.5	0.29±0.03 N·m (3 ±0.3 kgf·cm)	4

Step 3. Install the display unit in reverse order. When installing, ensure that the connectors are attached firmly.

**Notes:**

- When you route the cables, ensure that they are not subject to any tension. Tension could cause the cables to be damaged by the cable guides, or a wire to be broken.
- Attach the WLAN cable rubber to the specified position and route the cables neatly as illustrated. After attaching the WLAN antenna cables to the pin, place a piece of WLAN PC Mylar over the WLAN module.

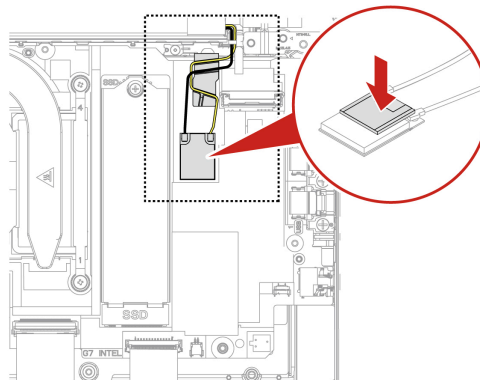

## Install new color profiles for display panel with the factory color calibration feature

Follow the instructions to install new color profiles for display panel with the factory color calibration feature.

- Step 1. Connect your computer to a network and close the X-Rite Color Assistant program.
- Step 2. Go to C:\Program files (x86)\X-Rite Color Assistant and locate the ProfileUpdaterForDisplayReplacement exe file.
- Step 3. Double-click the EXE file. Follow the on-screen instructions to input the display serial number and click **Submit**. You can find the display serial number and instructions on a sticker affixed to the front of the new display part. When the new color profiles are installed successfully, a prompted window will be displayed.

On Linux operating system based computers:

1. If color calibration profiles need to be reinstalled on a system, go to <https://support.lenovo.com/us/en/solutions/HT517038> to know the details.
2. If a panel is replaced and color calibration profiles need updating for the new panel, go to <https://support.lenovo.com/us/en/solutions/HT517060> to know the details.

---

## Display unit (ThinkPad T14s 2-in-1 Gen 2)

### Prerequisites

- Before you start, ensure that you have read “Before hardware replacement” on page 59 and complete all required steps.
- Tool needed: Phillips head screwdriver

### Replacement steps

- Step 1. Remove the “Base cover assembly” on page 61.
- Step 2. Remove the display unit as shown below.

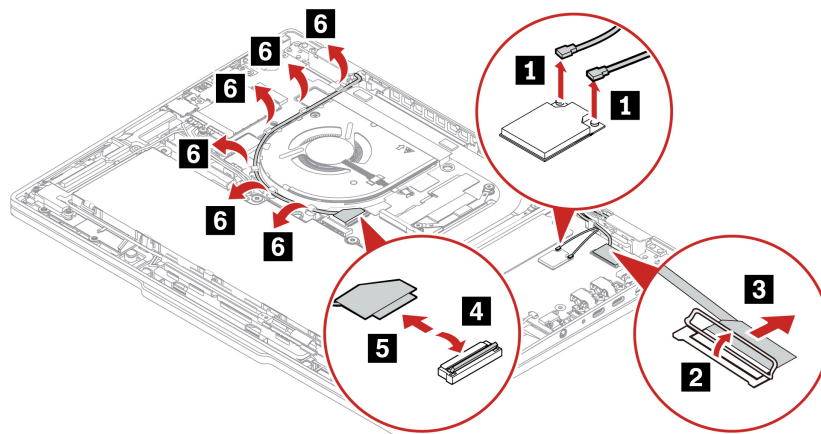

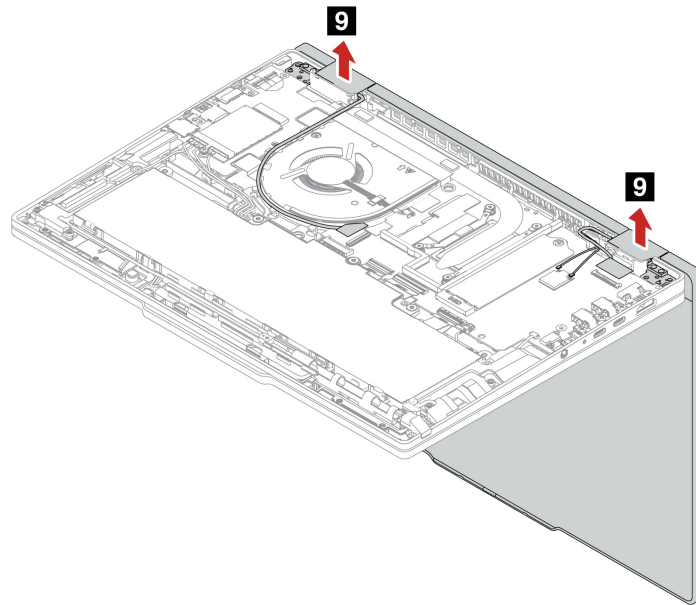
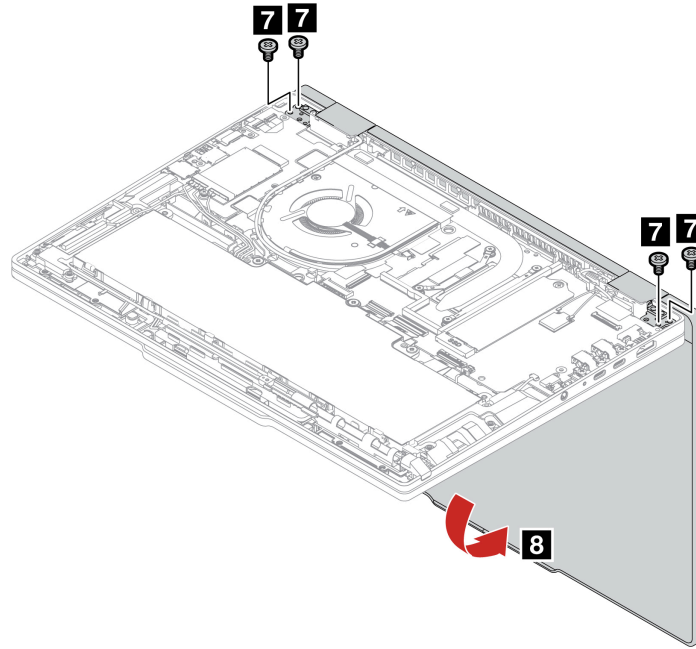

Step	Thread (mm)	Length (mm)	Torque	Quantity
<b>7</b>	M2.5	4.5	0.29±0.03 N·m (3 ±0.3 kgf·cm)	4

Step 3. Install the display unit in reverse order. When installing, ensure that the connectors are attached firmly.

**Notes:**

- When you route the cables, ensure that they are not subject to any tension. Tension could cause the cables to be damaged by the cable guides, or a wire to be broken.

- Secure the antenna cables in location **a** by applying acetate cloth tape to prevent cables movement as illustrated.

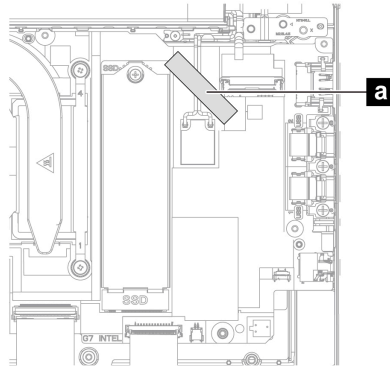

## Sensor calibration

Do the following to make sensor calibration:

Step 1. Download the Windows Sensor Calibration Tool by following steps:

**Note:** This Sensor Calibration Tool is limited to Lenovo service providers. You can contact a Lenovo authorized service provider to have your system board or display unit replaced.

- a. Go to <https://support.lenovo.com>.
- b. Log in to your Lenovo account on the Lenovo support website.
- c. Search for the product name, and then search for the Sensor Calibration Tool on the product page to download it.

Step 2. Extract the tool into a local driver, such as D:\WinCalibration

Step 3. Type `WindowsCalibrationTool.exe -calibrate a -minimal -updateiss -primaryonly` to create a `Update.bat` file as shown. Then, copy the file to the same folder of the Windows Sensor Calibration Tool.

 Update.bat - Notepad

File Edit Format View Help

```
WindowsCalibrationTool.exe -calibrate a -minimal -updateiss -primaryonly
```

Step 4. Run the `Update.bat` file as Administrator.

Step 5. Lay down the computer with the display panel facing up as shown and then follow the on-screen instructions to start the calibration process.

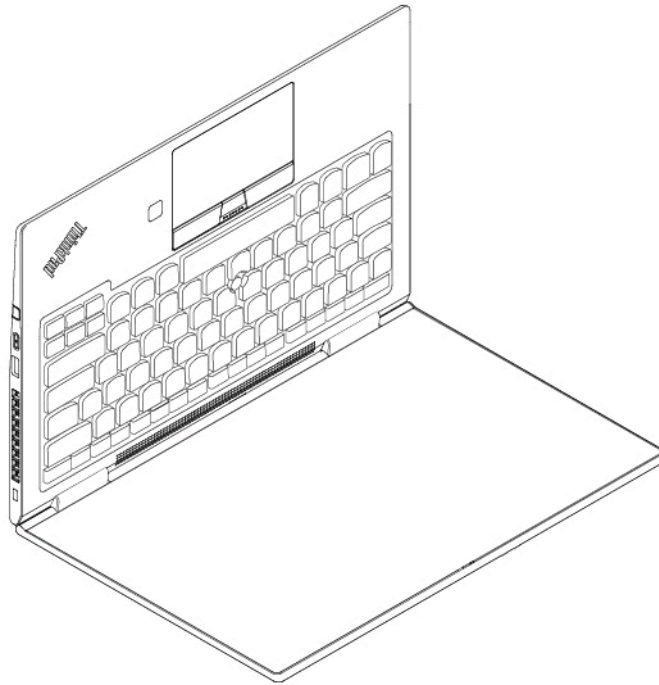

Step 6. Rotate the computer into Tablet mode and then follow the on-screen instructions to complete the calibration process.

**Note:** You might need to rotate the display in every aspect to ensure each mode works well.

## Install new color profiles for display panel with the factory color calibration feature

Follow the instructions to install new color profiles for display panel with the factory color calibration feature.

- Step 1. Connect your computer to a network and close the X-Rite Color Assistant program.
- Step 2. Go to C:\Program files (x86)\X-Rite Color Assistant and locate the ProfileUpdaterForDisplayReplacement exe file.
- Step 3. Double-click the EXE file. Follow the on-screen instructions to input the display serial number and click **Submit**. You can find the display serial number and instructions on a sticker affixed to the front of the new display part. When the new color profiles are installed successfully, a prompted window will be displayed.

On Linux operating system based computers:

1. If color calibration profiles need to be reinstalled on a system, go to <https://support.lenovo.com/us/en/solutions/HT517038> to know the details.
2. If a panel is replaced and color calibration profiles need updating for the new panel, go to <https://support.lenovo.com/us/en/solutions/HT517060> to know the details.

---

## Sub-USB board bracket

### Prerequisites

Before you start, ensure that you have read “Before hardware replacement” on page 59 and complete all required steps.

## Replacement steps

Step 1. Remove the “Base cover assembly” on page 61.

Step 2. Remove the Sub-USB board bracket as shown below.

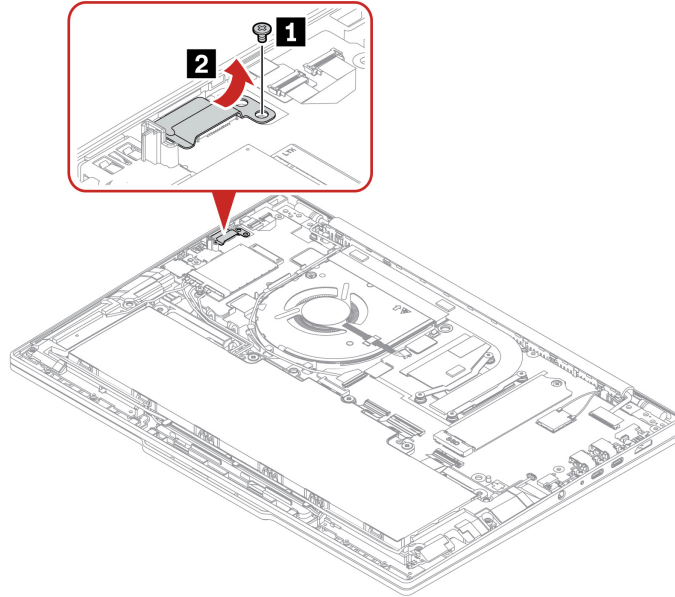

Step	Thread(mm)	Length (mm)	Torque	Quantity
<b>1</b>	M2	3	0.18±0.015 N·m (1.85 ±0.15 kgf·cm)	1

Step 3. Install the Sub-USB board bracket in reverse order.

---

## Fingerprint reader cable

### Prerequisites

Before you start, ensure that you have read “Before hardware replacement” on page 59 and complete all required steps.

### Replacement steps

Step 1. Remove the “Base cover assembly” on page 61.

Step 2. Disconnect the fingerprint reader cable from the fingerprint reader and the system board, and remove the cable as shown below.

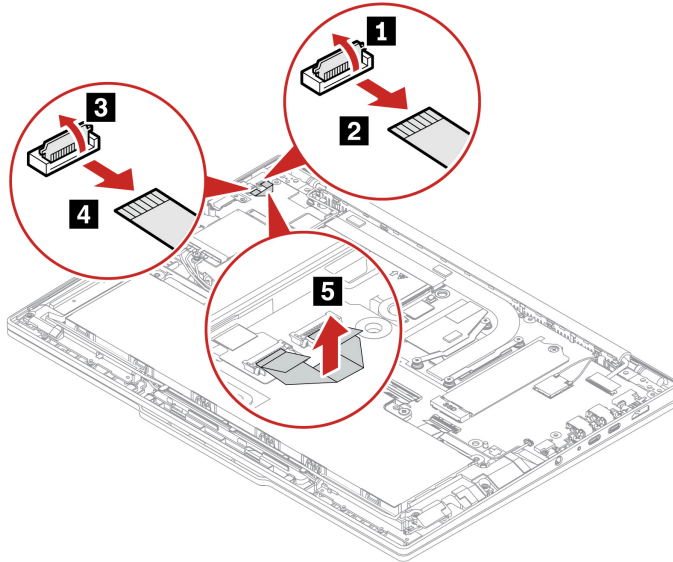

Step 3. Install the fingerprint reader cable in reverse order.

---

## USB I/O cable and wireless WAN I/O cable

### Prerequisites

Before you start, ensure that you have read “Before hardware replacement” on page 59 and complete all required steps.

### Replacement steps

Step 1. Remove the following parts in order.

- “Base cover assembly” on page 61
- “Built-in battery” on page 69
- “Thermal fan assembly” on page 71
- “Display unit (ThinkPad T14s Gen 7)” on page 82
- “Display unit (ThinkPad T14s 2-in-1 Gen 2)” on page 85

Step 2. Disconnect the USB I/O cable shown below.

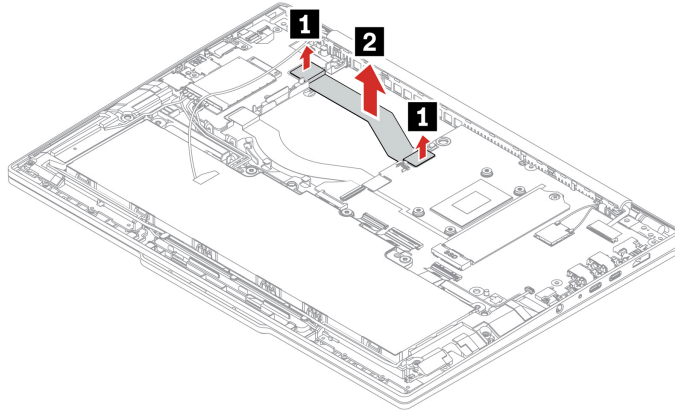

Step 3. Disconnect the wireless WAN I/O cable as shown below.

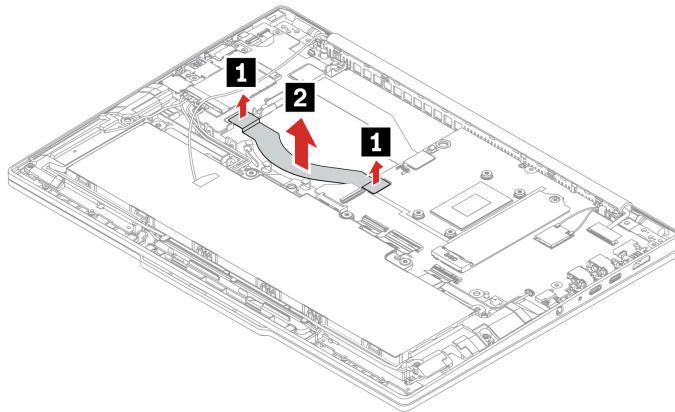

Step 4. Install the USB I/O cable and wireless WAN I/O cable in reverse order.

---

## Sub-USB board

### Prerequisites

- Before you start, ensure that you have read “Before hardware replacement” on page 59 and complete all required steps.
- Tool needed: Phillips head screwdriver

### Replacement steps

Step 1. Remove the following parts in order:

- “Base cover assembly” on page 61
- “Built-in battery” on page 69
- “Wireless WAN module and wireless WAN module bracket (for selected models)” on page 65
- “Wireless WAN antenna assembly (for selected models)” on page 74
- “Speaker assembly and wireless WAN MIMO antenna kits” on page 74
- “Sub-USB board bracket” on page 88
- “Fingerprint reader cable” on page 89

Step 2. Remove the Sub-USB board as shown below.

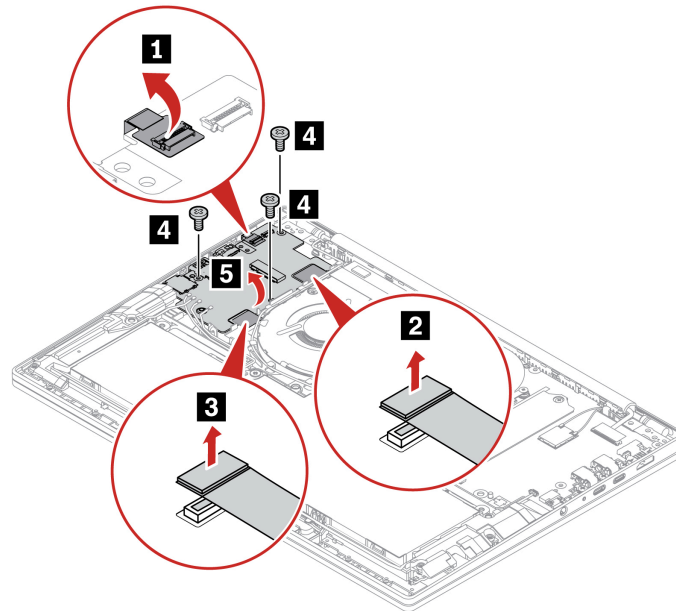

Step	Thread(mm)	Length (mm)	Torque	Quantity
4	M2	3	0.18±0.015 N·m (1.85 ±0.15 kgf·cm)	3

Step 3. Install the Sub-USB board in reverse order.

## Camera cable guide

### Prerequisites

Before you start, ensure that you have read “Before hardware replacement” on page 59 and complete all required steps.

### Replacement steps

Step 1. Remove the following parts in order:

- “Base cover assembly” on page 61
- “Built-in battery” on page 69
- “Wireless WAN module and wireless WAN module bracket (for selected models)” on page 65
- “Wireless WAN antenna assembly (for selected models)” on page 74
- “Speaker assembly and wireless WAN MIMO antenna kits” on page 74
- “Sub-USB board bracket” on page 88
- “Fingerprint reader cable” on page 89
- “Sub-USB board” on page 91

Step 2. Remove the camera cable guide as shown below.

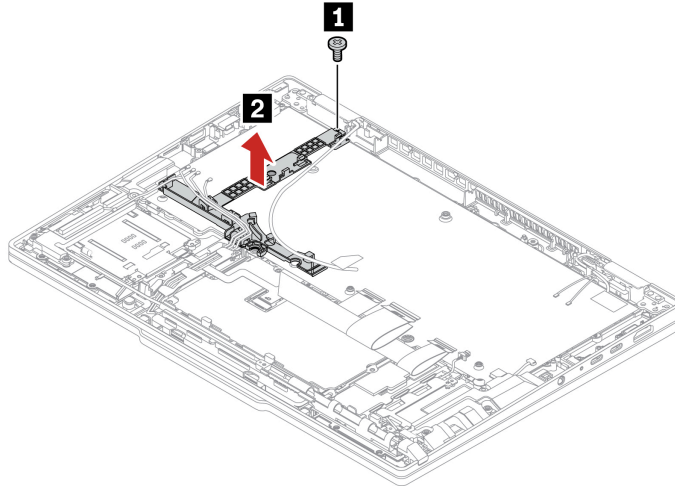

Step 3. Install the camera cable guide in reverse order.

Step	Thread (mm)	Length (mm)	Torque	Quantity
<b>1</b>	M1.6	2.6	0.1±0.015 N·m (1.1 ±0.15 kgf·cm)	1

## System board

### Prerequisites

- Before you start, ensure that you have read “Before hardware replacement” on page 59 and complete all required steps.
- Tool needed: Phillips head screwdriver

**Important:** When handling the system board, read the following:

- Some components mounted on a system board are very sensitive. Improper handling of a system board can cause damage to those components, and may cause a system malfunction.
- The system board has an accelerometer, which can be broken when several thousands of G-forces are applied.

**Note:** Dropping a system board from a height of as little as 6 inches so that it falls flat on a hard bench can subject the accelerometer to as much as 6000 G's of shock.

- Be careful not to drop the system board on a bench top that has a hard surface, such as metal, wood, or composite.
- Avoid rough handling of any kind.
- At every point in the process, be sure not to drop or stack the system board.
- If you put a system board down, be sure to put it only on a padded surface such as an ESD mat or a corrugated conductive surface.
- Avoid bending a system board and hard pushing to prevent cracking at each BGA (Ball Grid Array) chipset.

**Important:** Before replacing the system board, input following important product information to the new system board. For how to input the product information, refer to “Input the product information” on page 97.

Table 11. Product information introduction

Product information	Brief introduction	Where to find
Serial number	When the computer was manufactured, the EEPROM on the system board was loaded with the serial number of the system and all major components. These numbers need to remain the same throughout the life of the computer. If you replace the system board, you must restore the serial number of the system unit to its original value.	Find the serial number through either of the following methods: <ul style="list-style-type: none"> <li>• Locate the serial number on the label attached to the base cover of the computer.</li> <li>• Use the Maintenance Utility tool to read the serial number from the original system board. Refer to “Input the product information manually” on page 97.</li> </ul>
UUID	A 128-bit number uniquely assigned to the computer at production and stored in the EEPROM of system board. The algorithm that generates the number is designed to provide unique IDs until the year A.D. 3400. No two computers in the world have the same number.	As UUID is unique, it will be automatically generated when you use tool to input information.
Keyboard language ID	A code of four characters.	Go to <a href="https://support.lenovo.com/solutions/ht102004">https://support.lenovo.com/solutions/ht102004</a> for supported keyboard language ID list. Note: Only an authorized Lenovo service technician can access the above Web site.
Machine type model	The computer type number, a code of 10 characters.	Locate the machine type model on the label attached to the base cover of the computer.
Product name	The computer model name, such as “ThinkPad X1 Carbon Gen 9”.	Locate the product name on the base cover of the computer.

## Replacement steps

Step 1. Remove the following parts in order:

- “Base cover assembly” on page 61
- “M.2 solid-state drive and M.2 solid-state drive bracket” on page 63
- “Thermal fan assembly” on page 71
- “Speaker assembly and wireless WAN MIMO antenna kits” on page 74
- “Pen charge cable(for selected 2-in-1 models)” on page 77
- “Display unit (ThinkPad T14s Gen 7)” on page 82
- “Display unit (ThinkPad T14s 2-in-1 Gen 2)” on page 85
- “USB I/O cable and wireless WAN I/O cable” on page 90

Step 2. Disconnect the cables from the system board as shown below.

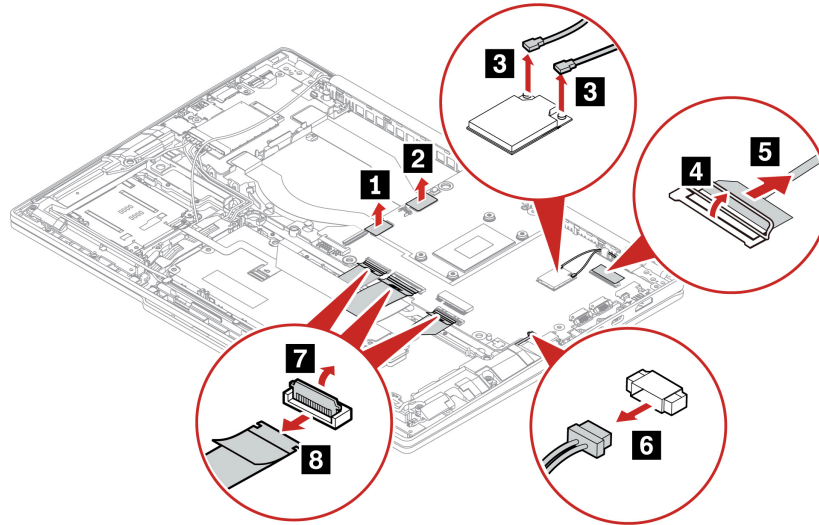

Step 3. Remove the screws and lift the system board as shown below.

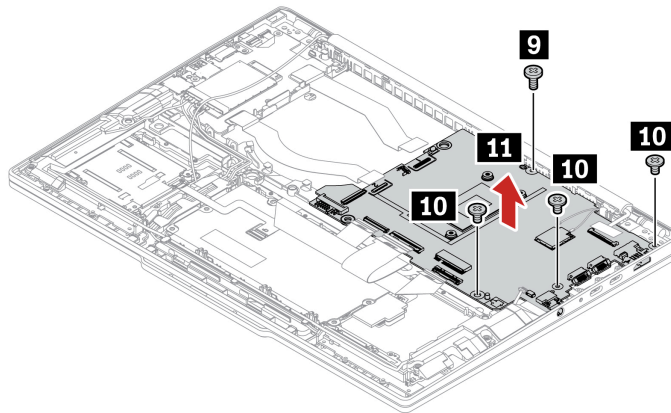

Step	Thread (mm)	Length (mm)	Torque	Quantity
<b>9</b>	M2	3.5	0.18±0.015 N·m (1.85 ±0.15 kgf·cm)	1
<b>10</b>	M2	3	0.18±0.015 N·m (1.85 ±0.15 kgf·cm)	3

Step 4. Install the system board in reverse order.

- To prevent noise caused by cable movement, please attach the original tape to the marked **12** position after installation. If it is damaged, you can also use painter's tape (masking tape) instead.

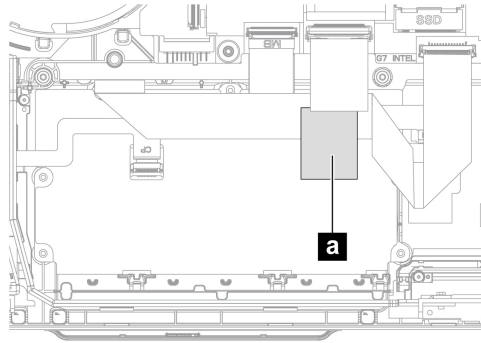

- There are two scenarios for securing the WLAN antenna cable.
  - For ThinkPad T14s Gen 7 models: Attach the WLAN cable rubber to the specified position and route the cables neatly as illustrated. After attaching the WLAN antenna cables to the pin, place a piece of WLAN PC Mylar over the WLAN module.

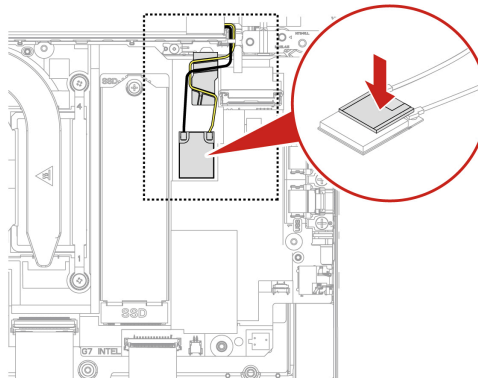

- For ThinkPad T14s 2-in-1 Gen 2 models: Secure the antenna cables in location **a** by applying acetate cloth tape to prevent cables movement as illustrated.

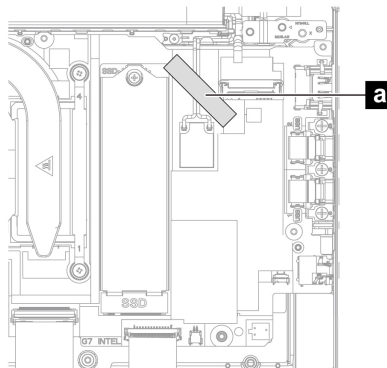

**Notes:**

- Ensure that the cable is attached firmly.
- Apply thermal grease and thermal gel on the thermal fan assembly if needed. For details, see “Thermal fan assembly” on page 71
- Ensure the adhesive side of the thermal pad is attached on the system board if a single-sided adhesive thermal pad is in use with the M.2 solid-state drive.
- Ensure all the consumable parts like mylar, thermal pad are pasted in place compared with the original one.

## Input the product information

After replacing the system board, you need to input the product information of the computer to the new system board.

- For service technicians, refer to “For service technician” on page 97.
- For end users, refer to “For end users” on page 99.

### For service technician

Use the Maintenance Utility tool to input the product information of the computer with the new system board.

#### Before you start

- Record the serial number and keyboard language ID
- For Intel models, ensure that the UEFI/Legacy setting within the **Startup** menu in the ThinkPad Setup program is set to **UEFI Only**.

#### Notes:

- For more instructions on the Maintenance Utility tool, refer to <https://support.lenovo.com/downloads/ds102472>.
- As an alternative, you also can use the Golden Key U1 tool to input the product information. Refer to <https://support.lenovo.com/solutions/ht102004> for instructions.

Step 1. Prepare a Maintenance Utility USB flash drive.

- Prepare a USB flash drive.

#### Notes:

- Depending on the specific ThinkPad being serviced, the required flash drive could be a USB A or USB C flash drive.
  - During the process, the content in the USB flash drive content will be erased.
- Go to <https://support.lenovo.com/downloads/ds102472> and follow the on-screen instructions to create a Maintenance Utility USB flash drive.

#### Notes:

- Only an authorized Lenovo service technician can access the above Web site.
- If you choose to import the product information automatically to the new system board, you need to create a folder named Data on the USB flash drive in advance.

Step 2. Input the product information manually or automatically.

- “Input the product information manually” on page 97
- “Input the product information automatically” on page 98

### Input the product information manually

Step 1. Connect the USB flash drive to the computer.

- Step 2. Restart the computer.
- Step 3. When the logo screen is displayed, press Esc. The ThinkPad Maintenance Utilities interface is displayed.

**Note:** You can also press F12 when the logo screen is displayed and select the bootable USB flash drive to run the Maintenance Utility tool.

- Step 4. On the ThinkPad Maintenance Utilities interface, Type 1 under **Enter the action desired**, then press Enter. The Planar Service Tools interface is displayed.
- Step 5. Type 1 under **Enter the action desired**, then press Enter. The serial number of the computer is displayed as a **20-** Serial number.
- Step 6. Type the serial number as displayed and press Enter.

**Note:** Ensure you type the correct serial number.

- Step 7. The brand name is displayed. Follow the on-screen instructions to complete the setting.

**Note:** For some products, you might need to input the keyboard language ID.

### Input the product information automatically

You need to export the product information from the original system board and then import them to the new system board.

- Step 1. Export the product information from the original system board.
- Connect the USB flash drive to the computer.
  - Restart the computer.
  - When the logo screen is displayed, press Esc. The ThinkPad Maintenance Utilities interface is displayed.

**Note:** You can also press F12 when the logo screen is displayed and select the bootable USB flash drive to run the Maintenance Utility tool.

- On the ThinkPad Maintenance Utilities interface, Type 1 under Enter the action desired, then press Enter. The Planar Service Tools interface is displayed.
- Type 2 under Enter the action desired, then press Enter. The ThinkPad Serial Number Update Utility for Asset ID interface is displayed.
- Type 1 to confirm to save the data to the USB key and follow the on-screen instructions to complete the setting.

- Step 2. Import the product information to the new system board.

- Connect the USB flash drive to the computer.
- Restart the computer.
- When the logo screen is displayed, press Esc. The ThinkPad Maintenance Utilities interface is displayed.

**Note:** You can also press F12 when the logo screen is displayed and select the bootable USB flash drive to run the Maintenance Utility tool.

- On the ThinkPad Maintenance Utilities interface, Type 1 under Enter the action desired, then press Enter. The Planar Service Tools interface is displayed.
- On the Planar Service Tools interface, Type 3 under Enter the action desired, then press Enter.
- Type 1 to confirm to write data to the EEPROM and follow the on-screen instructions to complete the setting.

## For end users

Use the ThinkPad system board self-repair tool to input the Machine Type Model (MTM) and Serial Number (SN), and select the product name and keyboard language of the computer after replacing a system board. For more details about the tool, go to: <https://support.lenovo.com/solutions/ht516543>.

**Note:** Ensure that the correct product information is input into the tool. **The input cannot be edited by end users once confirmed through the tool.** If the user exits during the process, the computer will shut down, and the tool will be launched again automatically every time when turning on the computer until the input is confirmed. The process of writing product information can only be used once and if unsure, consider getting support from a Lenovo-authorized service technician.

- Step 1. Turn on the computer. The tool will be started automatically.
- Step 2. Follow the on-screen instructions to input the MTM and SN, select the product name and keyboard language of the computer.
- Step 3. Click **YES** in the confirmation window and the tool will start to restore the BIOS configuration. The configuration process takes a few minutes to complete. When the BIOS configuration is finished, the computer will restart automatically.

---

## Power button with or without fingerprint reader and fingerprint reader bracket

### Prerequisites

- Before you start, ensure that you have read “Before hardware replacement” on page 59 and complete all required steps.
- Tool needed: Phillips head screwdriver

### Replacement steps

- Step 1. Remove the following parts in order:
  - “Base cover assembly” on page 61
  - “Sub-USB board” on page 91
- Step 2. Remove the power button with or without fingerprint reader as shown below.

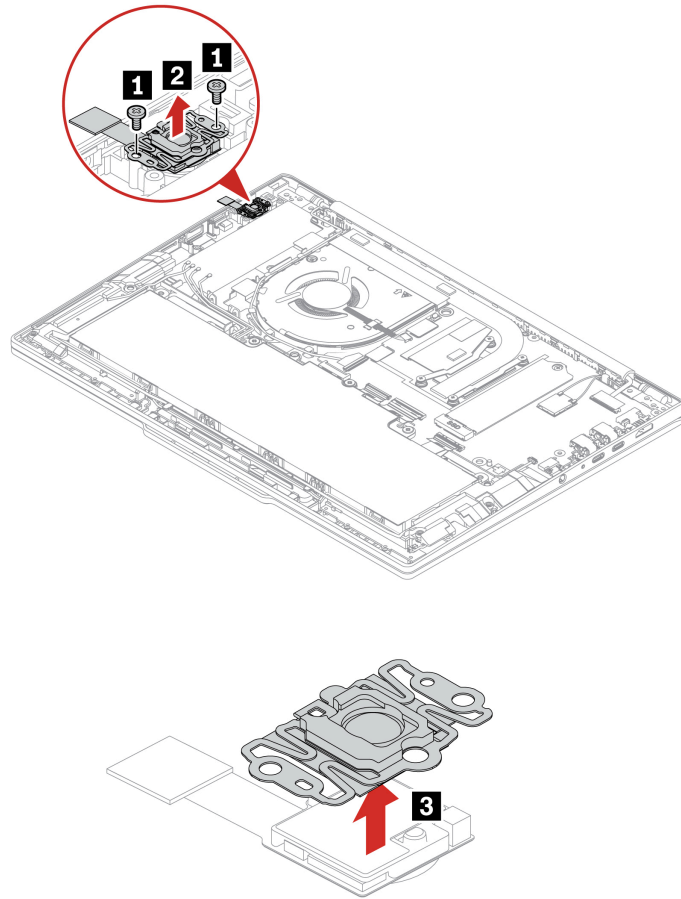

Step	Thread (mm)	Length (mm)	Torque	Quantity
<b>1</b>	M1.6	2.6	0.1±0.015 N·m (1.1 ±0.15 kgf·cm)	2

Step 3. Install the power button with or without fingerprint reader in reverse order.

## Trackpad and Trackpad waterproof mylar

### Prerequisites

- Before you start, ensure that you have read “Before hardware replacement” on page 59 and complete all required steps.
- Tool needed: Phillips head screwdriver

### Replacement steps

Step 1. Remove the following parts in order:

- “Base cover assembly” on page 61
- “Built-in battery” on page 69

Step 2. There might exist a waterproof mylar covering the Trackpad. Remove the mylar first.

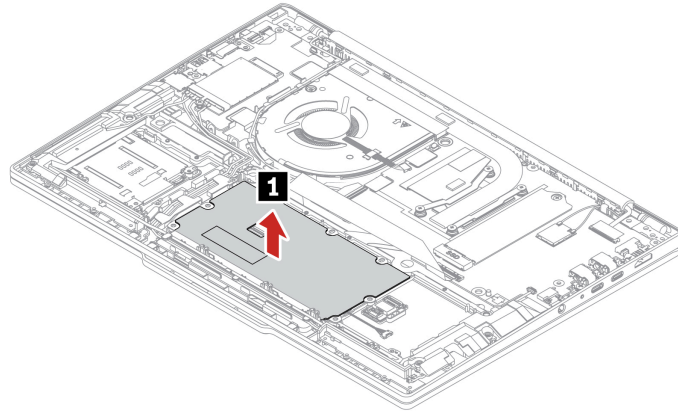

Step 3. Remove the Trackpad as shown below.

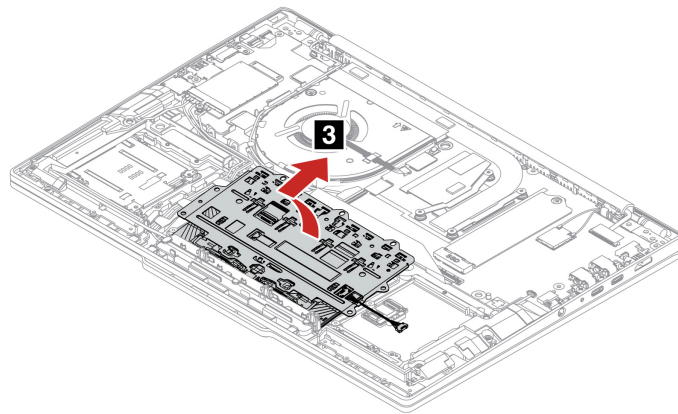
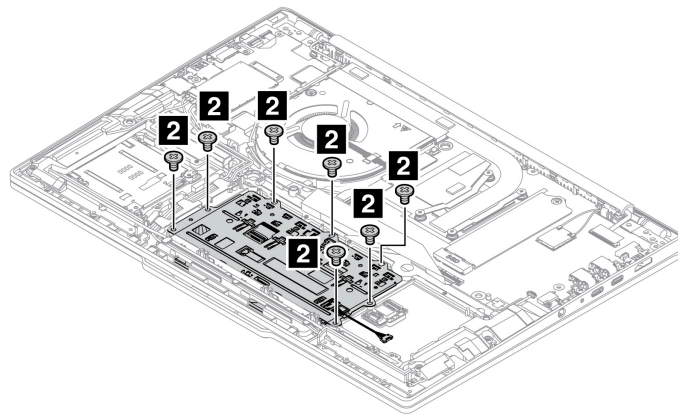

Step	Thread(mm)	Length (mm)	Torque	Quantity
<b>2</b>	M1.6	2.1	0.1±0.015 N·m (1.1 ±0.15 kgf·cm)	7

Step 4. A Trackpad jig might come with the Trackpad which is used for fixing the location of the Trackpad. Attach the Trackpad jig to the Trackpad and bend the four angles as shown by arrows below.

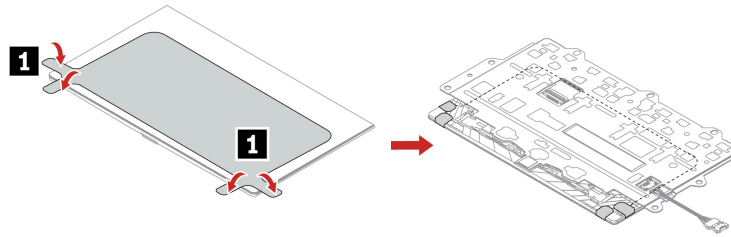

**Note:** If you do not have a JIG , you can use guage to manage the gap at 0.3 mm.

Step 5. Install the Trackpad with jig as shown.

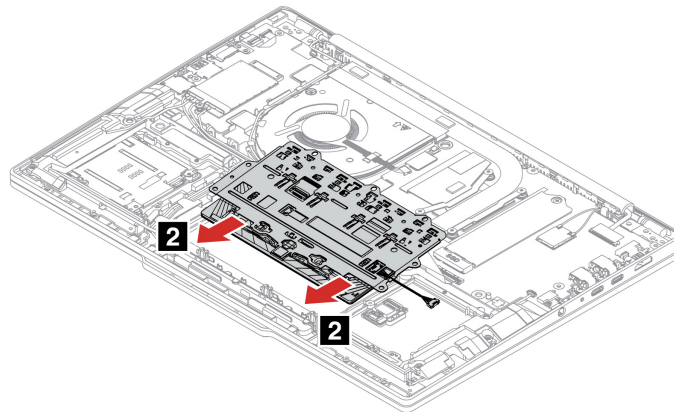

Step 6. Install the screws to fix the Trackpad.

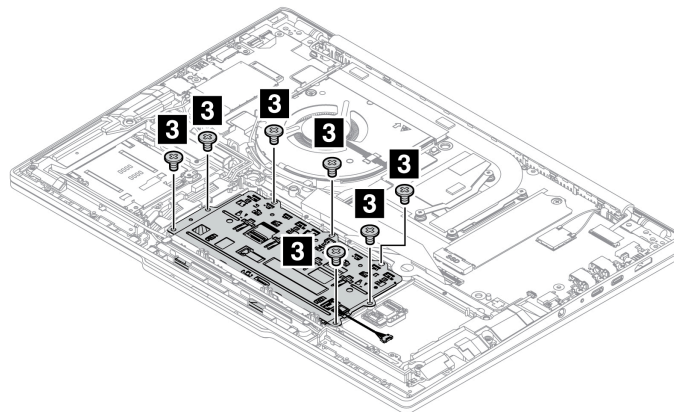

**Note:** Ensure that the connector is attached firmly.

Step 7. A mylar might cover the trackpad. Ensure that you attach the mylar to the trackpad after replacement.

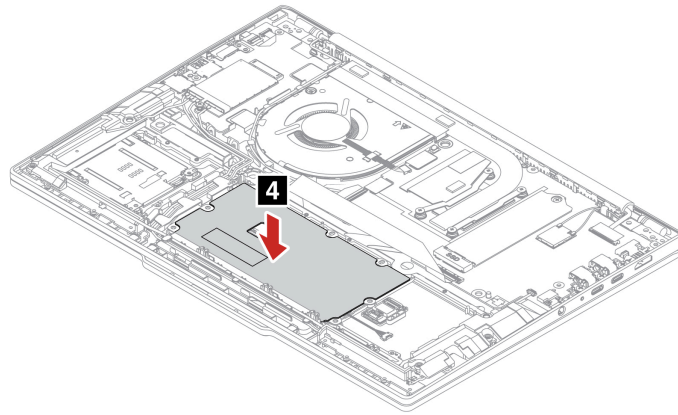

Step 8. Remove the jig.

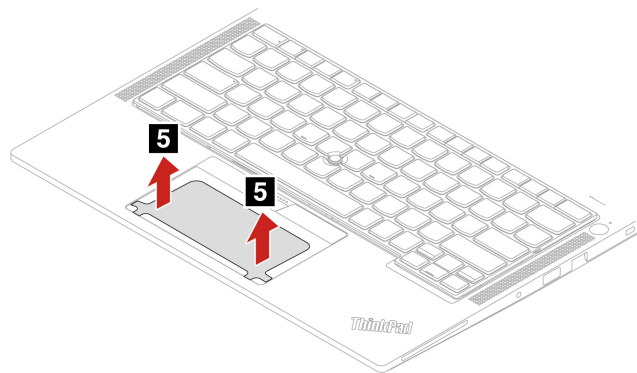

---

## Keyboard assembly

### Prerequisites

Before you start, ensure that you have read “Before hardware replacement” on page 59 and complete all required steps.

### Replacement steps

Step 1. Remove the following parts in order:

- “Base cover assembly” on page 61
- “M.2 solid-state drive and M.2 solid-state drive bracket” on page 63
- “Wireless WAN module and wireless WAN module bracket (for selected models)” on page 65
- “Built-in battery” on page 69
- “Thermal fan assembly” on page 71
- “Speaker assembly and wireless WAN MIMO antenna kits” on page 74
- “Wireless WAN antenna assembly (for selected models)” on page 74
- “Pen charge cable (for selected 2-in-1 models)” on page 77
- “NFC module (for selected models)” on page 78

- “Smart card reader and audio smart card sponge (for selected models)” on page 78
- “Dummy smart card (for selected models)” on page 80
- “Smart card reader-Trackpad-NFC cable (for selected models)” on page 81
- “Display unit (ThinkPad T14s Gen 7)” on page 82
- “Display unit (ThinkPad T14s 2-in-1 Gen 2)” on page 85
- “Sub-USB board bracket” on page 88
- “Fingerprint reader cable” on page 89
- “USB I/O cable and wireless WAN I/O cable” on page 90
- “Sub-USB board” on page 91
- “Camera cable guide” on page 92
- “System board” on page 93
- “Power button with or without fingerprint reader and fingerprint reader bracket” on page 99
- “Trackpad and Trackpad waterproof mylar” on page 100

Step 2. After performing the above steps, you are left with the keyboard assembly.

Step 3. Install parts listed in step 1 in reverse order.

---

## LCD FRUS and CRUS (ThinkPad T14s Gen 7)

### LCD bezel, LCD panel, LCD cable and elastic adhesive tapes

#### Prerequisites

- Before you start, ensure that you have read “Before hardware replacement” on page 59 and complete all required steps.
- Tools needed:
  - Phillips head screwdriver
  - Tweezers

#### Replacement steps

Step 1. Remove the following parts in order.

- “Base cover assembly” on page 61
- “Display unit (ThinkPad T14s Gen 7)” on page 82

Step 2. Remove the LCD bezel, LCD panel, LCD cable and elastic adhesive tapes as shown below.

- a. Remove the LCD bezel as shown below, then pull out each tape slowly in the direction as shown until the adhesive tapes are all released from LCD unit.

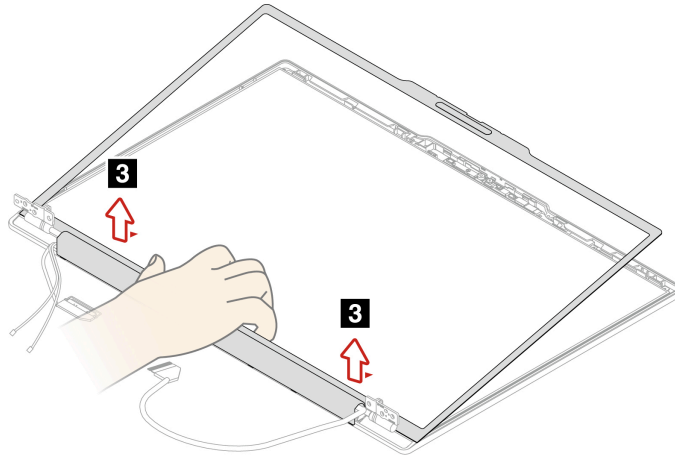
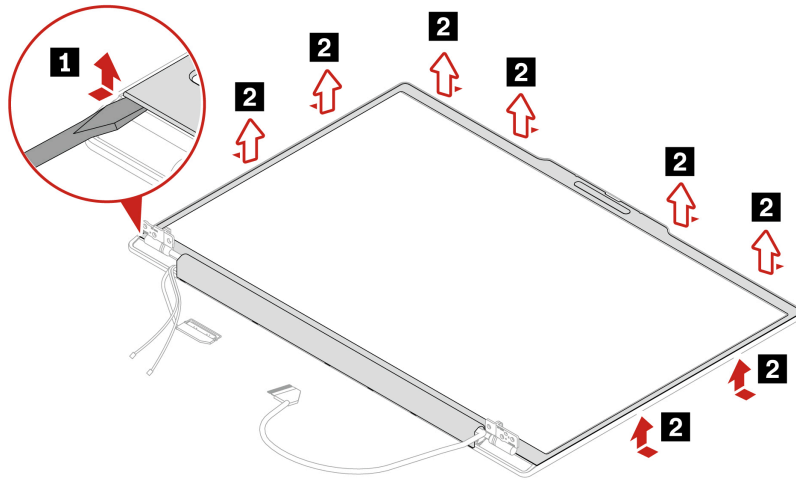

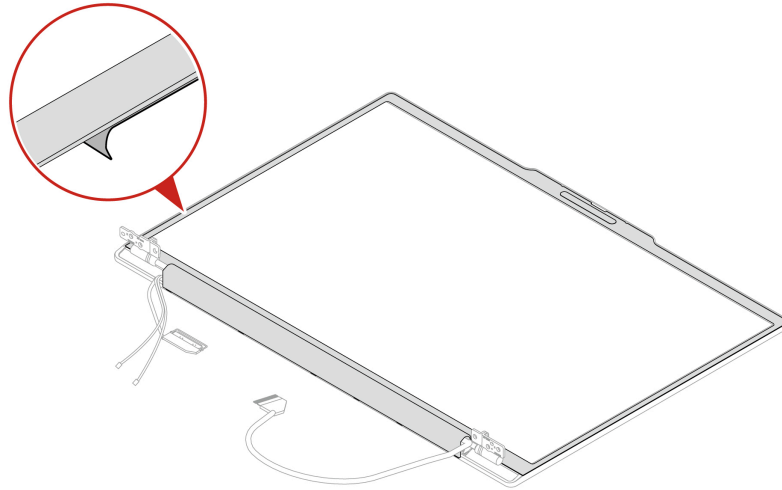

**Note:** If the LCD bezel is difficult to remove, peel off the adhesive tape on the back as shown in the figure, then try to remove the LCD bezel again.

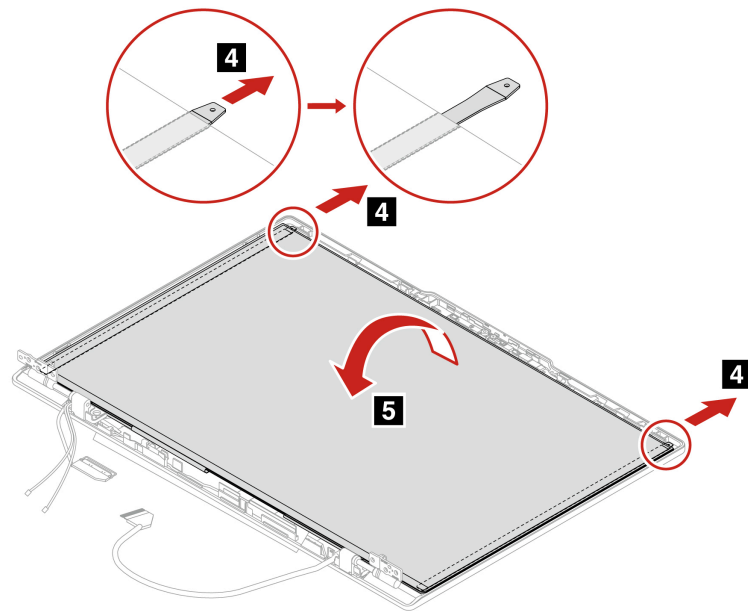

**Note:** Do not pull the tapes too fast, otherwise, the tapes might snap.

- b. Turn over the LCD panel and detach the LCD cable from the LCD panel as shown.

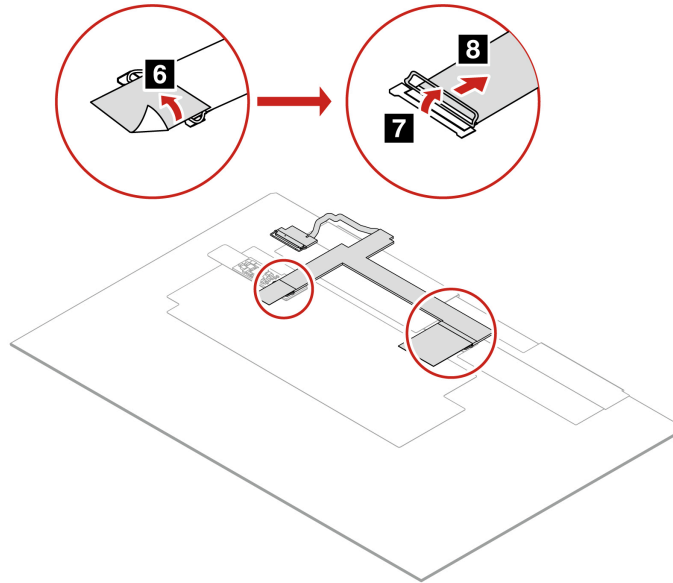

Step 3. Install the LCD panel, LCD cable and elastic adhesive tapes as shown below.

- a. Peel off the release liners from one side of the new elastic adhesive tapes. Apply the tapes to the correct locations. Ensure the small handles of the elastic adhesive tapes are exposed. Peel off the release liners from the other side of the tapes. Ensure that the tapes are applied correctly as shown.

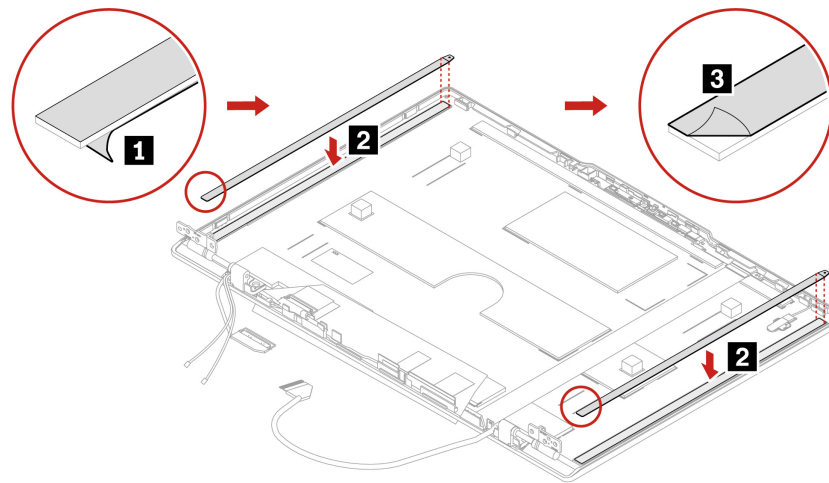

- b. Attach the LCD cable to the LCD panel as shown. Turn over the LCD panel to secure the LCD panel with tapes.

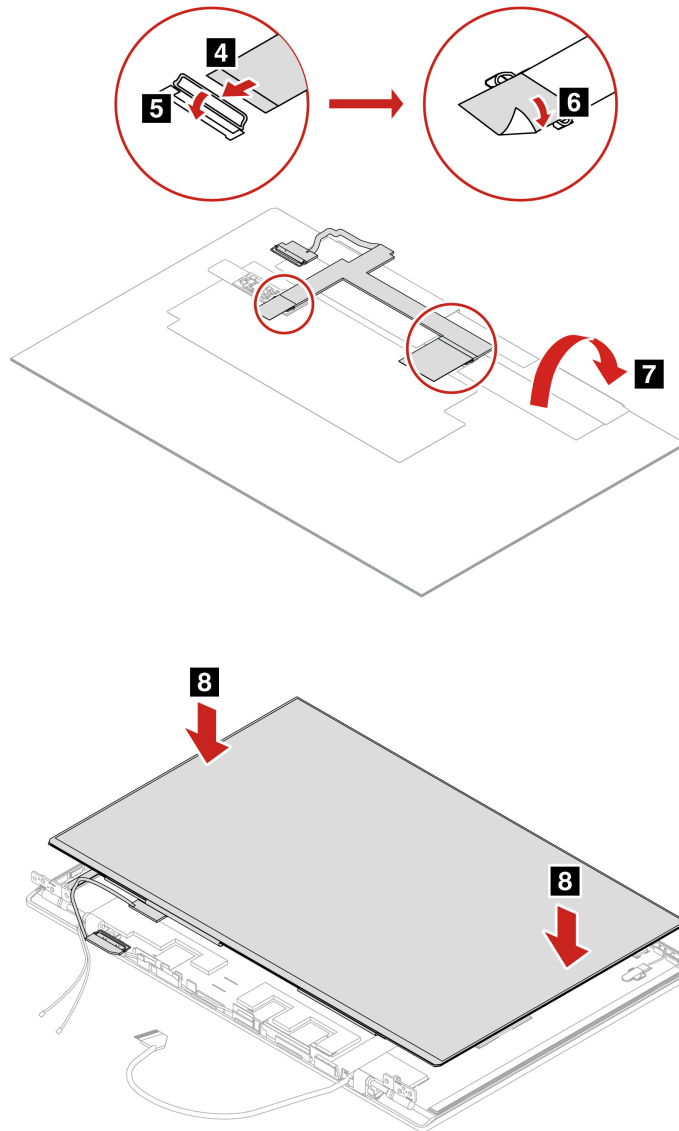

**Note:** When installing, ensure that the connector is attached firmly.

- c. Install the LCD bezel in reverse order. When installing, ensure that all the latches are attached firmly.

**Note:** After the LCD bezel is removed, it's not recommended to be used anymore. A new LCD bezel is required for replacement.

## Camera shutter

### Prerequisites

- Before you start, ensure that you have read “Before hardware replacement” on page 59 and complete all required steps.
- Tool needed:
  - Phillips head screwdriver
  - Tweezers

## Replacement steps

Step 1. Remove the following parts in order.

- “Base cover assembly” on page 61
- “Display unit (ThinkPad T14s Gen 7)” on page 82
- “LCD bezel, LCD panel, LCD cable and elastic adhesive tapes” on page 104

Step 2. Remove the camera shutter as shown below.

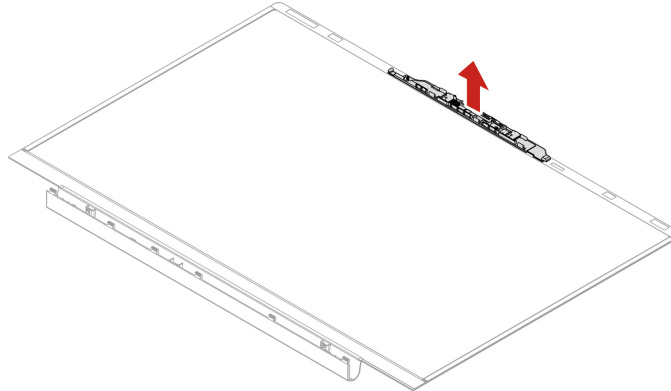

Step 3. Install the camera shutter in reverse order.

## Camera-and-microphone module and cable (for selected models)

### Prerequisites

- Before you start, ensure that you have read “Before hardware replacement” on page 59 and complete all required steps.
- Tool needed:
  - Phillips head screwdriver
  - Tweezers

### Replacement steps

Step 1. Remove the following parts in order.

- “Base cover assembly” on page 61
- “Display unit (ThinkPad T14s Gen 7)” on page 82
- “LCD bezel, LCD panel, LCD cable and elastic adhesive tapes” on page 104
- “Camera shutter” on page 108

Step 2. Remove the camera-and-microphone module as shown below.

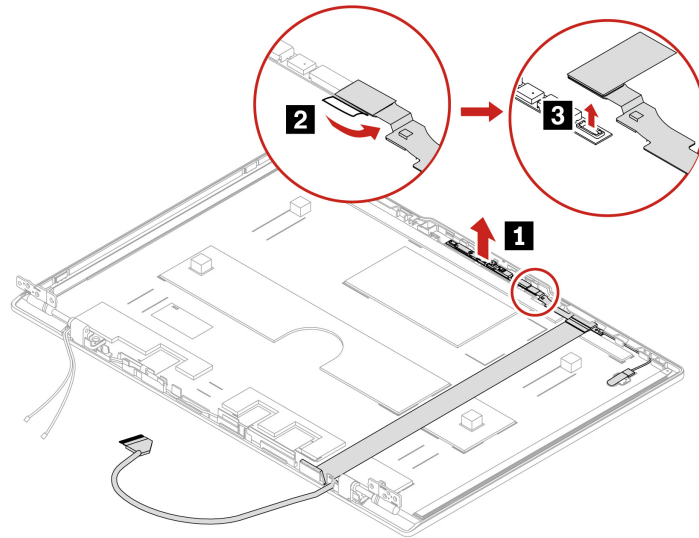

Step 3. Remove the camera-and-microphone cable as shown below.

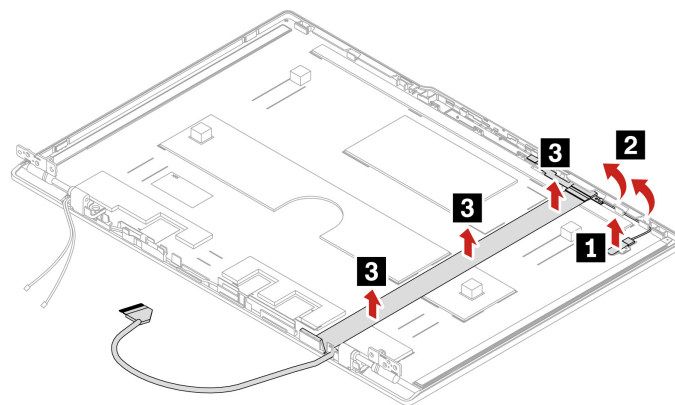

Step 4. Install the camera-and-microphone module and cable in reverse order.

## Wireless LAN antenna assembly

### Prerequisites

- Before you start, ensure that you have read “Before hardware replacement” on page 59 and complete all required steps.
- Tool needed:
  - Phillips head screwdriver
  - Tweezers

### Replacement steps

Step 1. Remove the following parts in order.

- “Base cover assembly” on page 61
- “Display unit (ThinkPad T14s Gen 7)” on page 82
- “LCD bezel, LCD panel, LCD cable and elastic adhesive tapes” on page 104

- “Camera shutter” on page 108
- “Camera-and-microphone module and cable (for selected models)” on page 109

Step 2. Remove the Wireless LAN antenna assembly as shown below.

a. Type 1

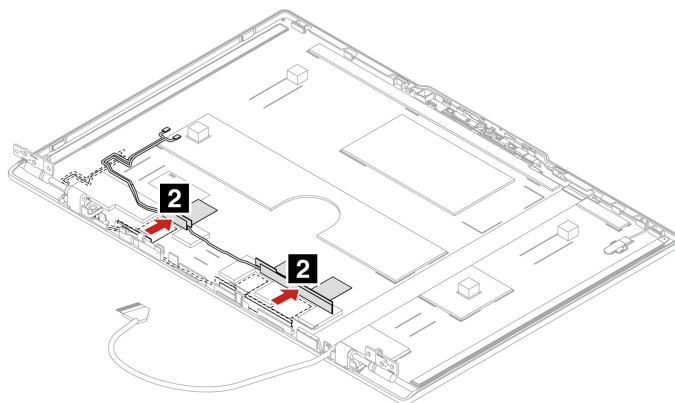
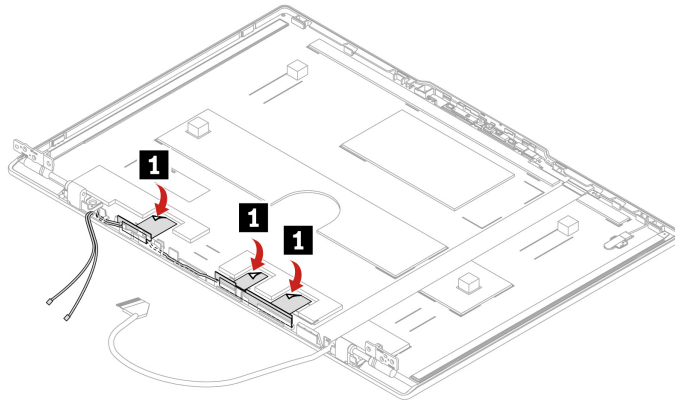

b. Type 2

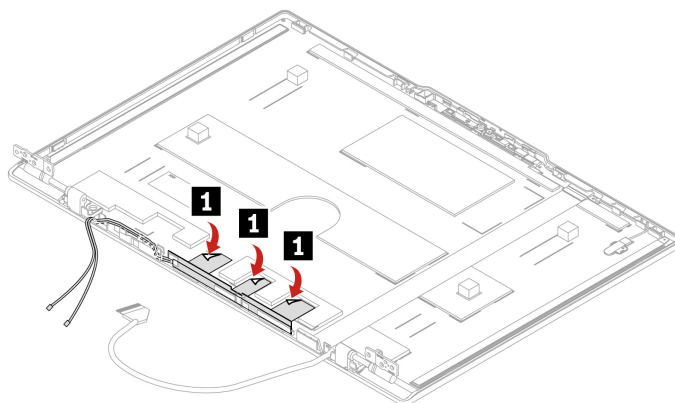

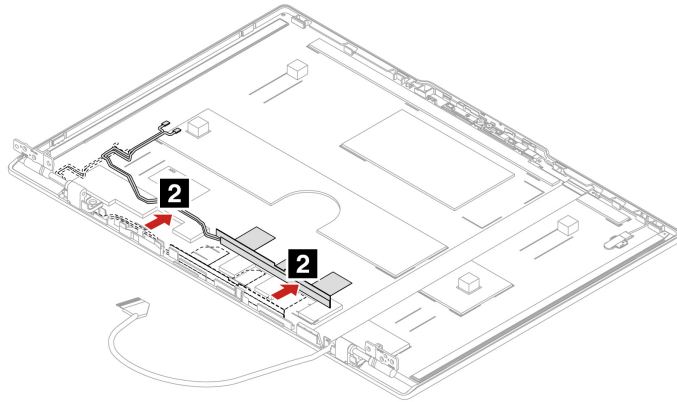

Step 3. Install the Wireless LAN antenna assembly in reverse order.

## Strip cover and LCD hinges

### Prerequisites

- Before you start, ensure that you have read “Before hardware replacement” on page 59 and complete all required steps.
- Tool needed: Phillips head screwdriver

Step 1. Remove the following parts in order.

- “Base cover assembly” on page 61
- “Display unit (ThinkPad T14s Gen 7)” on page 82
- “LCD bezel, LCD panel, LCD cable and elastic adhesive tapes” on page 104
- “Camera shutter” on page 108
- “Camera-and-microphone module and cable (for selected models)” on page 109
- “Wireless LAN antenna assembly” on page 110

Step 2. Remove the strip cover and LCD hinges as shown below.

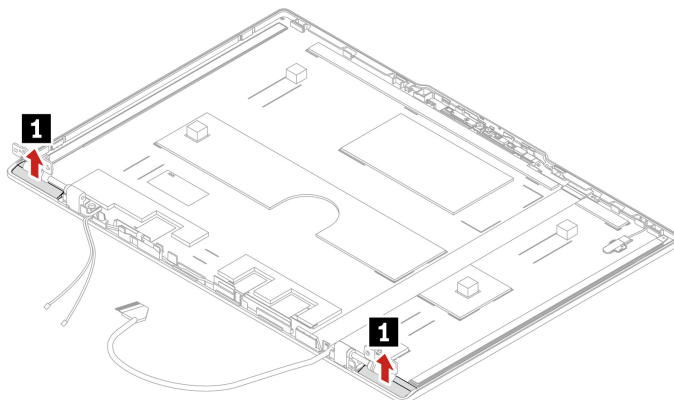

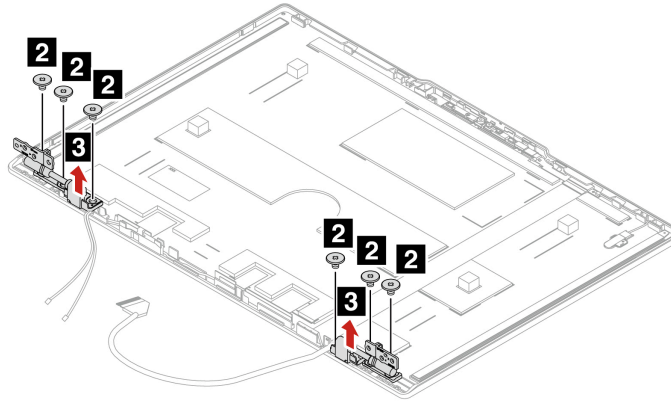

Step	Thread (mm)	Length (mm)	Torque	Quantity
<b>2</b>	M2.5	2.5	0.29±0.03 N·m (3 ±0.3 kgf·cm)	6

Step 3. Install the strip cover and LCD hinges in reverse order.

## LCD cover assembly

### Prerequisites

Before you start, ensure that you have read “Before hardware replacement” on page 59 and complete all required steps.

### Replacement steps

Step 1. Remove the following parts in order:

- “Base cover assembly” on page 61
- “Display unit (ThinkPad T14s Gen 7)” on page 82
- “LCD bezel, LCD panel, LCD cable and elastic adhesive tapes” on page 104
- “Camera shutter” on page 108
- “Camera-and-microphone module and cable (for selected models)” on page 109
- “Wireless LAN antenna assembly” on page 110
- “Strip cover and LCD hinges” on page 112

Step 2. After performing the above steps, you are left with the LCD cover assembly.

Step 3. Install parts listed in the prerequisites in reverse order.

---

## LCD FRUS and CRUS (ThinkPad T14s 2-in-1 Gen 2)

### LCD strip cover

#### Prerequisites

- Before you start, ensure that you have read “Before hardware replacement” on page 59 and complete all required steps.
- Tools needed:

- Phillips head screwdriver
- Pry tool
- Tweezers

### Replacement steps

Step 1. Remove the following parts in order.

- “Base cover assembly” on page 61
- “Display unit (ThinkPad T14s 2-in-1 Gen 2)” on page 85

Step 2. Remove the LCD strip cover as shown below.

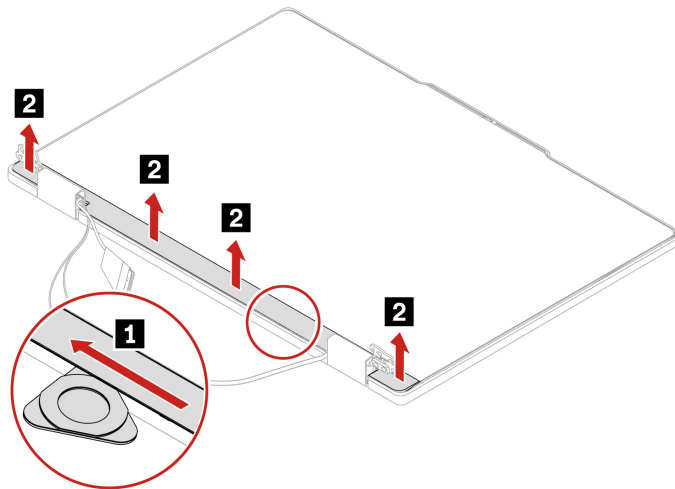

Step 3. Install the LCD strip cover in reverse order.

## LCD hinges and hinges cover

### Prerequisites

- Before you start, ensure that you have read “Before hardware replacement” on page 59 and complete all required steps.
- Tool needed: Phillips head screwdriver

Step 1. Remove the following parts in order.

- “Base cover assembly” on page 61
- “Display unit (ThinkPad T14s 2-in-1 Gen 2)” on page 85
- “LCD strip cover” on page 113

Step 2. Remove the LCD hinges and hinges cover as shown below.

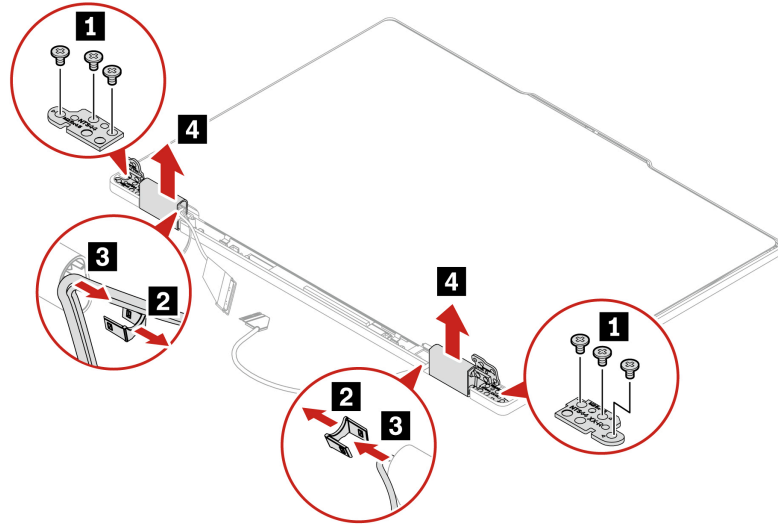

Step	Thread (mm)	Length (mm)	Torque	Quantity
<b>2</b>	M2.5	2.5	0.29 ± 0.03 N·m (3 ± 0.3 kgf·cm)	6

Step 3. Install the LCD hinges and hinges cover in reverse order.

## LCD cable, LCD panel and elastic adhesive tapes

### Prerequisites

- Before you start, ensure that you have read “Before hardware replacement” on page 59 and complete all required steps.
- Tools needed:
  - Phillips head screwdriver
  - Tweezers

### Replacement steps

Step 1. Remove the following parts in order.

- “Base cover assembly” on page 61
- “Display unit (ThinkPad T14s 2-in-1 Gen 2)” on page 85
- “LCD strip cover” on page 113
- “LCD hinges and hinges cover” on page 114

Step 2. Remove the LCD panel, LCD cable and elastic adhesive tapes as shown below.

**Note:** Do not pull the tapes too fast, otherwise, the tapes might snap.

Step 3. Turn over the LCD panel and detach the LCD cable from the LCD panel as shown.

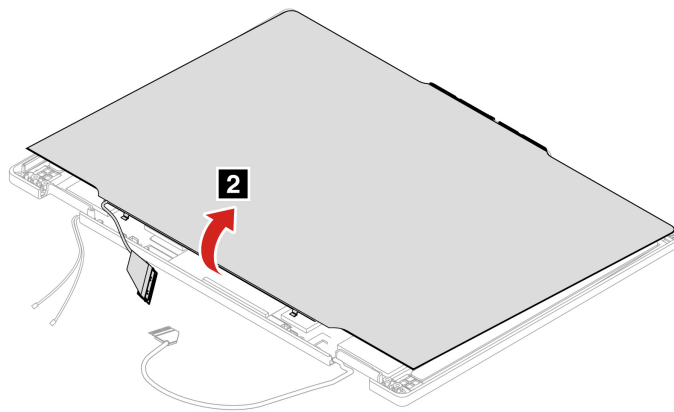
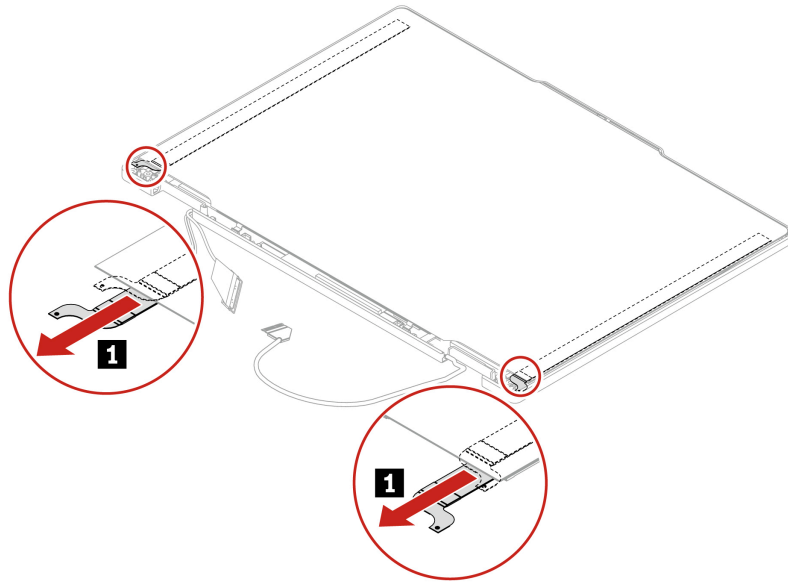

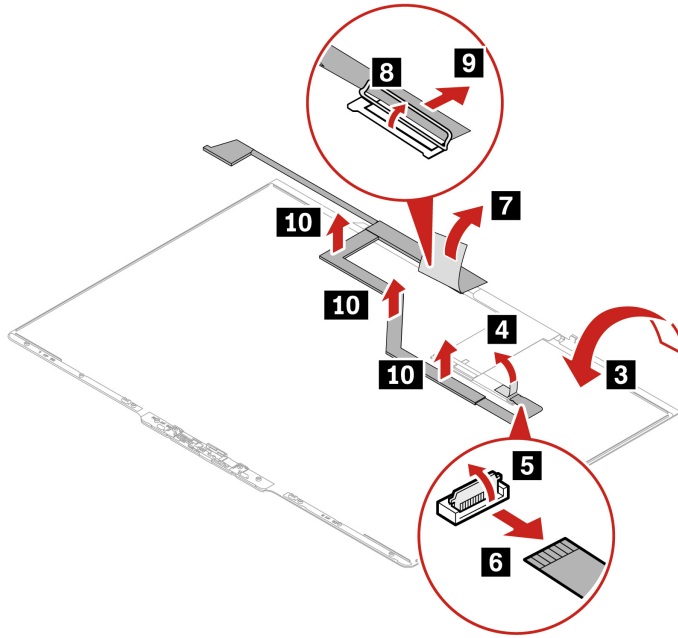

Step 4. Install the LCD panel, LCD cable and elastic adhesive tapes as shown below.

- a. Peel off the release liners from one side of the new elastic adhesive tapes. Apply the tapes from the top of the black frame. Ensure the small handles of the elastic adhesive tapes are exposed. Then peel off 4/1 release liners from the other side of the tapes.

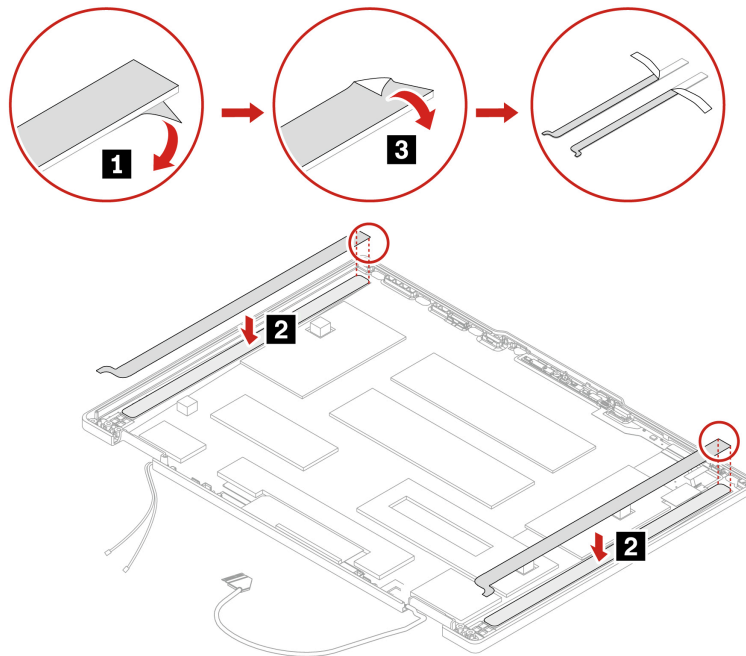

- b. Attach the LCD cable to the LCD panel as shown.

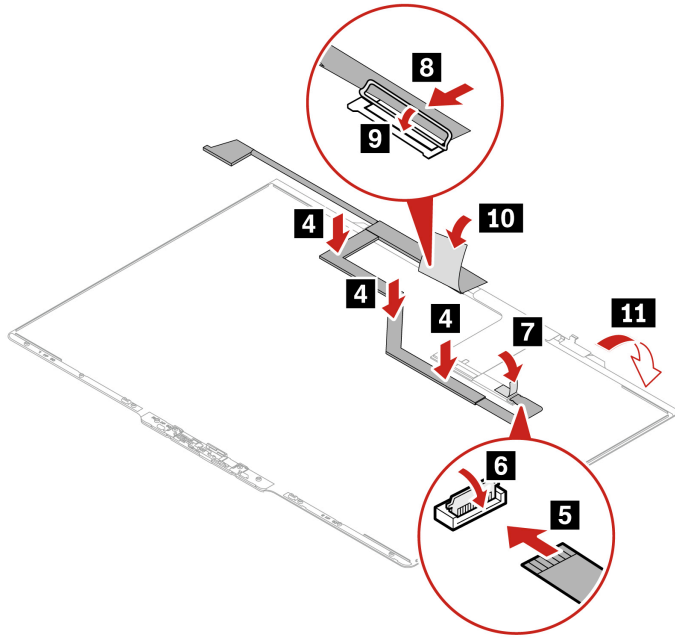

- c. Turn over the LCD panel and insert it diagonally into the top of the LCD cover assembly. Ensure there is no gap between the top of the LCD panel and the A cover.

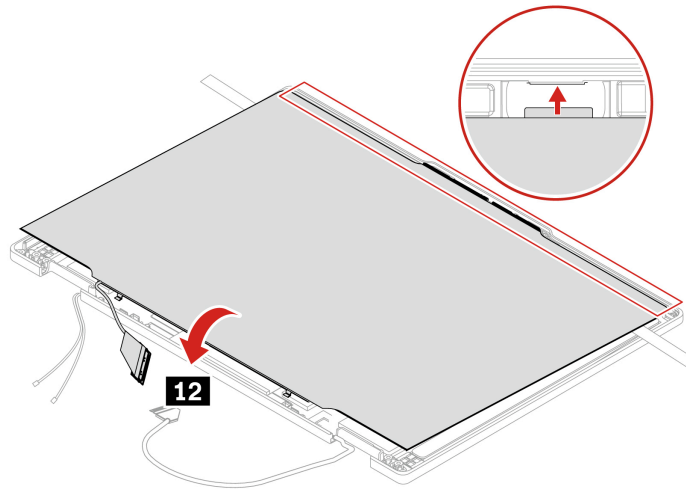

- d. Press the LCD panel by hand and peel off the release liners to secure the LCD panel with tapes.

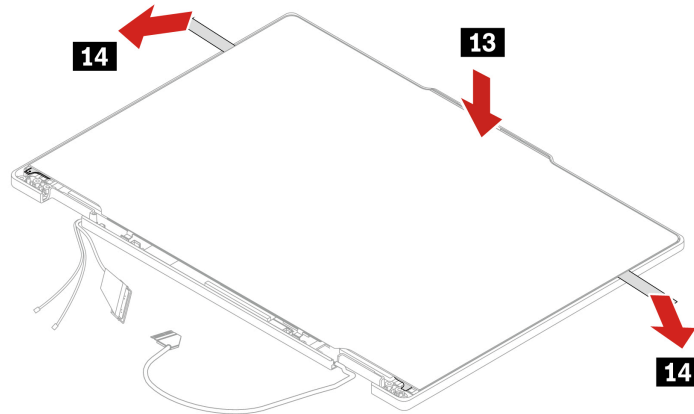

**Note:** When installing, ensure that the connector is attached firmly.

## Camera-and-microphone cable and module (for selected models)

### Prerequisites

- Before you start, ensure that you have read “Before hardware replacement” on page 59 and complete all required steps.
- Tool needed:
  - Phillips head screwdriver
  - Tweezers

### Replacement steps

Step 1. Remove the following parts in order.

- “Base cover assembly” on page 61
- “Display unit (ThinkPad T14s 2-in-1 Gen 2)” on page 85
- “LCD strip cover” on page 113
- “LCD hinges and hinges cover” on page 114
- “LCD cable, LCD panel and elastic adhesive tapes” on page 115

Step 2. Remove the camera-and-microphone module as shown below.

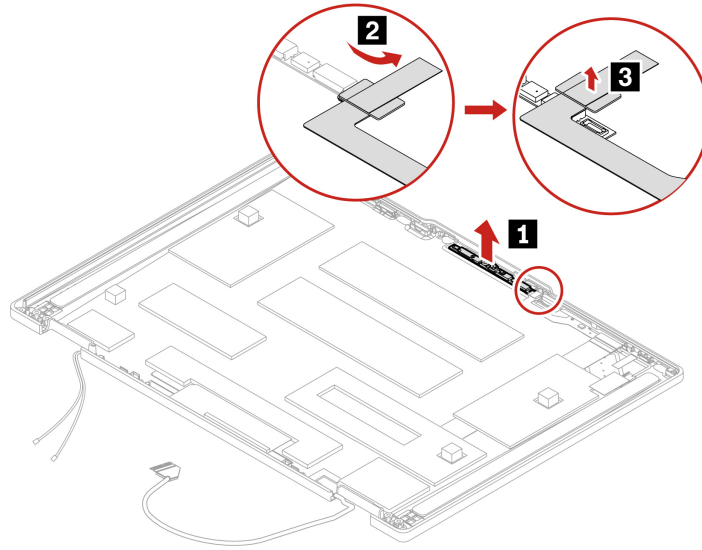

Step 3. Remove the camera-and-microphone cable as shown below.

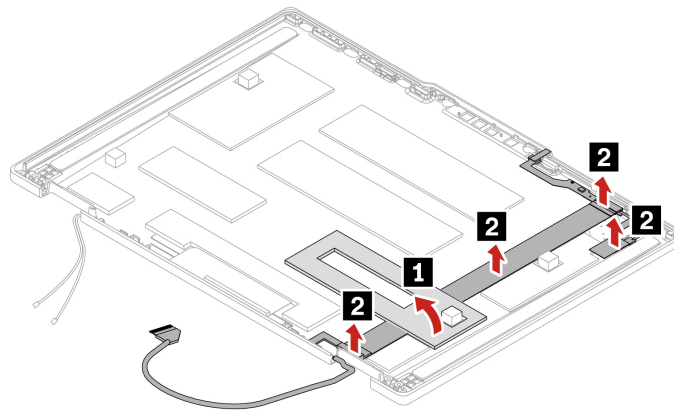

Step 4. Install the camera-and-microphone module and cable in reverse order.

## WLAN antenna assembly

### Prerequisites

- Before you start, ensure that you have read “Before hardware replacement” on page 59 and complete all required steps.
- Tool needed:
  - Phillips head screwdriver
  - Tweezers

### Replacement steps

Step 1. Remove the following parts in order.

- “Base cover assembly” on page 61
- “Display unit (ThinkPad T14s 2-in-1 Gen 2)” on page 85

- “LCD strip cover” on page 113
- “LCD hinges and hinges cover” on page 114
- “LCD cable, LCD panel and elastic adhesive tapes” on page 115
- “Camera-and-microphone cable and module (for selected models)” on page 119

Step 2. Remove WLAN antenna assembly as shown below.

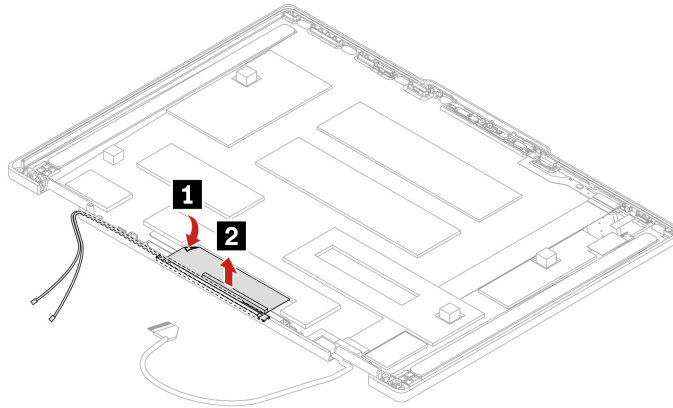

Step 3. Install the WLAN antenna assembly in reverse order.

## LCD cover assembly for 2-in-1 models

### Prerequisites

Before you start, ensure that you have read “Before hardware replacement” on page 59 and complete all required steps.

### Replacement steps

Step 1. Remove the following parts in order:

- “Base cover assembly” on page 61
- “Display unit (ThinkPad T14s 2-in-1 Gen 2)” on page 85
- “LCD strip cover” on page 113
- “LCD hinges and hinges cover” on page 114
- “LCD cable, LCD panel and elastic adhesive tapes” on page 115
- “Camera-and-microphone cable and module (for selected models)” on page 119
- “WLAN antenna assembly ” on page 120

Step 2. After performing the above steps, you are left with the LCD cover assembly.

Step 3. Install parts listed in the prerequisites in reverse order.

---

## Chapter 6. Supplemental instructions













---

### Use the keyboard shortcuts





Keyboard shortcuts are keys or combinations of keys that provide a quick way to perform particular functions. They help you work more efficiently.

The following tables introduce the functions of keyboard shortcuts.

#### FnLock and function keys

Key / Key combination	Function description
	Switch between the special and standard functions of the function keys (F1–F12).
Fn+FnLock	Function keys provide two sets of functions: special function and standard function. Icons on the key denote the special function, such as  and  . Characters on the key denote the standard function, such as F1 and F2.  LED indicator on Esc key indicates which function of the function keys is enabled: <ul style="list-style-type: none"><li>• When the indicator is off, the special function is enabled.</li><li>• When the indicator is on, the standard function is enabled.</li></ul>
	Mute / Unmute (Speakers).
	Decrease volume.
	Increase volume.
	Enable / Disable the microphone.
	Decrease screen brightness.
	Increase screen brightness.
	Select and set up display devices.
mode	Change power mode.
prt sc	Print screen.
	Open the Snipping Tool.
	Launch the Smart Connect app.
	Customize the function of this key in the Vantage app.

## Other general keyboard shortcuts

Key / key combination	Function description
	<ul style="list-style-type: none"><li>• Launch Copilot in Windows.</li><li>• Launch Windows Search.</li></ul> <b>Note:</b> The function varies by countries or regions.
fn+ 	Adjust the keyboard backlight.
fn+ 	Go to beginning.
fn+ 	Go to end.
fn+Tab	Open Magnifier. <b>Note:</b> Press the Windows logo key+Esc to turn it off.
fn+4	Enter sleep mode.
fn+B	Break operation.
fn+K	Scroll lock.
fn+P	Pause operation.
fn+S	Send system request.
Fn+N	Open the system information window.
Fn+G	Enable / Disable the tapping gesture to launch TrackPoint Quick Menu.

You can customize keyboard settings in the Vantage app. To customize detailed settings, open the Vantage app, and then click **Device settings** → **Input**.

For more keyboard shortcuts, go to <https://support.lenovo.com/solutions/windows-support>.

## Install, upgrade, and recover operating system

### Install a Windows operating system

**Problem:** How to install a Windows operating system?

**Solution:** To install a Windows operating system, take the following steps:

**Attention:**

- It is recommended that you update your operating system through official channels. Any unofficial update might cause security risks.
- The process of installing a new operating system deletes all the data on your internal storage drive, including the data stored in a hidden folder.
- Before installing or upgrading a particular Windows version, make a backup copy of all the data that you want to keep.
- Ensure that your computer is connected to the network and ac power during the whole process.

1. Get your computer ready for installing a Windows operating system. Take the following steps:

- a. Microsoft® constantly makes updates to the Windows operating system. Before installing a particular Windows version, check the compatibility list and the minimum system requirements for the Windows version. For details, go to <https://support.lenovo.com/solutions/ht512575>.
  - b. For models with a Trusted Platform Module, if you are using the Windows BitLocker® Drive Encryption feature, ensure that you have disabled the feature. You can re-enable the feature after the operating system installation is complete.
  - c. Enable the security-related features (Security Chip, Virtualization, and Secure Boot). Take the following steps:
    - 1) Restart the computer. When the logo screen is displayed, choose one of the following solutions to enter the UEFI BIOS menu depending on your computer model:
      - For ThinkPad and ThinkBook computers: Press F1.
      - For Yoga and IdeaPad computers: Press F2.
    - 2) Select **Security** and select the security-related features. Then, press Enter. Ensure that the security-related features are enabled.
    - 3) Press F10 to save the settings and exit.
2. Connect the drive that contains the operating system installation program to the computer.  
To create the installation media, refer to <https://support.microsoft.com/windows>.
  3. Restart the computer. When the logo screen is displayed, choose one of the following solutions to enter the UEFI BIOS menu depending on your computer model:
    - For ThinkPad and ThinkBook computers: Press F1.
    - For Yoga and IdeaPad computers: Press F2.
  4. Choose one of the following solutions depending on your computer model:
    - For ThinkPad computers: Select **Startup** → **Boot** to open the **Boot Priority Order** submenu.
    - For ThinkBook, Yoga, and IdeaPad computers: Select **Boot**.
  5. Change the startup sequence. Take the following steps:
    - a. Select the drive that contains the operating system installation program. Choose one of the following solutions depending on your computer model:
      - For ThinkPad computers: Such as **USB HDD**. Then, press Esc.
      - For ThinkBook, Yoga, and IdeaPad computers: Such as **USB Boot**. Then, press Esc.
    - b. Press F10 to save the setting and exit.

**Attention:** After you change the startup sequence, ensure that you select the correct device during a copy, save, or format operation. If you select the wrong device, the data on that device might be erased or overwritten.

**Note:** If the system cannot boot from the selected drive, disable **Secure Boot** and try again. Ensure that you re-enable the feature after the operating system installation is complete.
  6. Follow the on-screen instructions to install the device drivers and necessary programs.

If the problem persists, do not hesitate to call Lenovo Customer Center. For the latest Lenovo Support phone numbers for your country or region, go to <https://pcsupport.lenovo.com/supportphonenumber>.

## Windows operating system installation error

**Problem:** What should I do if the installation of Windows operating system fails?

**Solution:** If the installation of Windows operating system fails, take the following steps:

1. Read the error message to figure out the specific cause.
2. Ensure that the UEFI BIOS version on your device is up-to-date.
3. Ensure that the available disk space of your computer meets the requirement of the new Windows operating system.
4. If you had antivirus software or a firewall installed on the previous system, temporarily disable the antivirus functionality within the BIOS before attempting system installation.
5. Reinstall the Windows system.

If the problem persists, do not hesitate to call Lenovo Customer Center. For the latest Lenovo Support phone numbers for your country or region, go to <https://pcsupport.lenovo.com/supportphonenumber>.

## Upgrade my Windows operating system

**Problem:** How to upgrade my Windows operating system?

**Solution:** To upgrade your Windows operating system, take the following steps:

### Attention:

- It is recommended that you upgrade your operating system through official channels. Any unofficial update might cause security risks.
  - Before upgrading a particular Windows version, make a backup copy of all the data that you want to keep.
  - Ensure that your computer is connected to the network and ac power during the whole process.
1. Get your computer ready for updating the Windows operating system. Take the following steps:
    - a. Microsoft constantly makes updates to the Windows operating system. Before upgrading a particular Windows version, check the compatibility list and the minimum system requirements for the Windows version. For details, go to <https://support.lenovo.com/solutions/ht512575>.
    - b. For models with a Trusted Platform Module, if you are using the Windows BitLocker® Drive Encryption feature, ensure that you have disabled the feature. You can re-enable the feature after the operating system installation is complete.
    - c. Enable the security-related features (Security Chip, Virtualization, and Secure Boot). Take the following steps:
      - 1) Restart the computer. When the logo screen is displayed, choose one of the following ways to enter the UEFI BIOS menu depending on your computer model:
        - For ThinkPad and ThinkBook computers: Press F1.
        - For Yoga and IdeaPad computers: Press F2.
      - 2) Select **Security** and select the security-related features. Then, press Enter. Ensure that the security-related features are enabled.
      - 3) Press F10 to save the settings and exit.
  2. Type **Windows Update** in the Windows search box and press Enter.
  3. Click **Check for updates**. If an operating system update package is available, it will be automatically downloaded and installed.
  4. Follow the on-screen instructions to install the device drivers and necessary programs.

If the problem persists, do not hesitate to call Lenovo Customer Center. For the latest Lenovo Support phone numbers for your country or region, go to <https://pcsupport.lenovo.com/supportphonenumber>.

## Windows operating system upgrading error

**Problem:** What should I do if the upgrading of Windows operating system fails?

**Solution:** If the upgrading of Windows operating system fails, take the following steps:

1. Read the error message to figure out the specific cause.
2. Ensure that the UEFI BIOS version on your device is up-to-date.
3. Ensure that the available disk space of your computer meets the requirement of the new Windows operating system.
4. Upgrade the system again.

If the problem persists, do not hesitate to call Lenovo Customer Center. For the latest Lenovo Support phone numbers for your country or region, go to <https://pcsupport.lenovo.com/supportphonenumber>.

## Recover my Windows operating system

**Problem:** How to recover my Windows operating system?

**Solution:** To recover your Windows operating system, choose one of the following recovery options:

- **Reset system to factory default:**

Refer to the instructions in <https://support.lenovo.com/HowToCreateLenovoRecovery>.

- **Other recovery options such as recovering system to a previous system point:**

Refer to the instructions in Popular Topics: <https://support.lenovo.com/solutions/ht118590>.

Here are some frequently-asked cases and solutions for your reference:

Cases	Solutions
Your computer does not work well and you recently installed a device from Windows Update.	Remove the installed update device.
Your computer does not work well and it has been a while since you installed an app or changed system settings.	Reset your system.
Your computer cannot start or is still loading.	Use the Startup Repair function.
Your computer cannot start, you have not created a recovery drive, and resetting your computer does not work.	Use installation media to reinstall Windows operating system.
Your computer cannot start and you have not created a recovery drive.	Use installation media to restore your computer.
Your computer cannot start and you have created a recovery drive.	Use a recovery drive to restore or recover your computer.
You want to reinstall your previous operating system.	Go back to your previous version of Windows operating system.
Your computer does not work well and you recently installed an app.	Restore from a system restore point.
You suspect your device has been infected.	Use installation media to reinstall Windows operating system.

If the problem persists, do not hesitate to call Lenovo Customer Center. For the latest Lenovo Support phone numbers for your country or region, go to <https://pcsupport.lenovo.com/supportphonenumber>.

## Windows operating system recovery error

**Problem:** What should I do if the recovery of Windows operating system fails?

**Solution:** If the recovery of Windows operating system fails, take the following steps:

1. Read the error message to figure out the specific cause.
2. Ensure that the computer is connected to the network and ac power source.
3. Ensure that the UEFI BIOS version on your device is up-to-date.
4. Ensure that the available disk space of your computer meets the requirement of the new Windows operating system.
5. Reinstall the Windows operating system.

If the problem persists, do not hesitate to call Lenovo Customer Center. For the latest Lenovo Support phone numbers for your country or region, go to <https://pcsupport.lenovo.com/supportphonenumberlist>.

---

## Passwords

### UEFI BIOS passwords

You can set passwords in UEFI (Unified Extensible Firmware Interface) BIOS (Basic Input/Output System) to strengthen the security of your computer.

#### Password types

You can set a power-on password, supervisor password, system management password, or NVMe password in UEFI BIOS to prevent unauthorized access to your computer.

However, you are not prompted to enter any UEFI BIOS password when your computer resumes from sleep mode.

#### Power-on password

If you set a power-on password, a window is displayed on the screen when you turn on the computer. Enter the correct password to use the computer.

#### Supervisor password

The supervisor password protects the system information stored in UEFI BIOS. When entering the UEFI BIOS menu, enter the correct supervisor password in the window prompted. You also can press Enter to skip the password prompt. However, you cannot change most of the system configuration options in UEFI BIOS.

If you have set both the supervisor password and power-on password, you can use the supervisor password to access your computer when you turn it on. The supervisor password overrides the power-on password.

#### NVMe passwords

The NVMe password prevents unauthorized access to the data on the storage drive. When an NVMe password is set, you are prompted to type a correct password each time you try to access the storage drive.

- **Single Password**

When a Single NVMe password is set, the user must enter the user NVMe password to access files and applications on the storage drive.

- **Dual Password (User+Admin)**

The admin NVMe password is set and used by a system administrator. It enables the administrator to access any storage drive in a system or any computer connected in the same network. The administrator can also assign a user NVMe password for each computer in the network. The user of the computer can change the user NVMe password as desired, but only the administrator can remove the user NVMe password.

When prompted to enter an NVMe password, press F1 to switch between the admin NVMe password and user NVMe password.

**Notes:** The NVMe password is not available in the following situations:

- A Trusted Computing Group (TCG) Opal-compliant storage drive and a TCG Opal management software program are installed in the computer, and the TCG Opal management software program is activated.
- An eDrive storage drive is installed in the computer preinstalled with the Windows operating system.

### **System management password**

The system management password can also protect the system information stored in UEFI BIOS like a supervisor password, but it has lower authority by default. The system management password can be set through the UEFI BIOS menu or through Windows Management Instrumentation (WMI) with the Lenovo client-management interface.

You can enable the system management password to have the same authority as the supervisor password to control security-related features. To customize the authority of the system management password through the UEFI BIOS menu:

- Step 1. Restart the computer. When the logo screen is displayed, press F1 to enter the UEFI BIOS menu.
- Step 2. Select **Security → Password → System Management Password Access Control**.
- Step 3. Follow the on-screen instructions.

If you have set both the supervisor password and the system management password, the supervisor password overrides the system management password. If you have set both the system management password and the power-on password, the system management password overrides the power-on password.

### **Set, change, or remove a password**

Follow the instructions to set, change or remove a password.

Before you start, print these instructions.

- Step 1. Restart the computer. When the logo screen is displayed, press F1 to enter the UEFI BIOS menu.
- Step 2. Select **Security → Password** by using the arrow keys.
- Step 3. Select the password type. Then, follow the on-screen instructions to set, change, or remove a password.

You should record all your passwords and store them in a safe place. If you forget any of your passwords, any potential repair actions required are not covered under warranty.

### **What to do if you forget your power-on password**

Follow the instructions to remove the power-on password if you forget your power-on password.

If you have set a supervisor password or a system management password and remember it:

- Step 1. Restart the computer. When the logo screen is displayed, immediately press F1.

- Step 2. Type the supervisor password or the system management password to enter the UEFI BIOS menu.
- Step 3. Select **Security → Password → Power-On Password** by using the arrow keys.
- Step 4. Type the current supervisor password or the system management password in the **Enter Current Password** field. Then, leave the **Enter New Password** field blank, and press Enter twice.
- Step 5. In the Changes have been saved window, press Enter.
- Step 6. Press F10 to save changes and exit the UEFI BIOS menu.

If you have not set a supervisor password or a system management password, contact a Lenovo-authorized service provider to have the power-on password removed.

### **What to do if you forget your system management password**

Follow the instructions to remove the system management password if you forget your system management password.

If you have set a supervisor password and remember it:

- Step 1. Restart the computer. When the logo screen is displayed, immediately press F1.
- Step 2. Type the supervisor password to enter the UEFI BIOS menu.
- Step 3. Select **Security → Password → System Management Password** by using the arrow keys.
- Step 4. Type the current supervisor password in the **Enter Current Password** field. Then, leave the **Enter New Password** field blank, and press Enter twice.
- Step 5. In the Changes have been saved window, press Enter.
- Step 6. Press F10 to save changes and exit the UEFI BIOS menu.

If you have not set a supervisor password, contact a Lenovo-authorized service provider to have the system management password removed.

### **What to do if you forget your NVMe password**

Follow the instructions to remove the NVMe password if you forget your NVMe password.

If you forget your NVMe password (Single password) or both user and admin NVMe passwords (Dual password), Lenovo cannot reset your passwords or recover data from the storage drive. You can contact a Lenovo-authorized service provider to have the storage drive replaced. A fee will be charged for parts and service. If the storage drive is a CRU/FRU, you can also contact Lenovo to purchase a new storage drive to replace the old one by yourself. To check whether the storage drive is a CRU/FRU and the relevant replacement procedure, see “Exploded view and part list” on page 45.

### **What to do if you forget your supervisor password**

There is no service procedure to remove the password. You can contact a Lenovo-authorized service provider to have the system board replaced. A fee will be charged for parts and service.

### **Associate your fingerprints with passwords (for selected models)**

You can associate the fingerprints with passwords to get quick access to the computer and the data on the storage drive without entering the power-on password or NVMe password.

Do the following to associate your fingerprints with the power-on password and NVMe password:

- Step 1. Turn off and then turn on the computer.
- Step 2. When prompted, scan your finger on the fingerprint reader.
- Step 3. Enter your power-on password, NVMe password, or both as required. The association is established.

When you start the computer again, you can use your fingerprints to log in to the computer without entering your Windows password, power-on password, or NVMe password. To change settings, press F1 to enter the UEFI BIOS menu, and then select **Security → Fingerprint**.

**Attention:** If you always use your fingerprint to log in to the computer, you might forget your passwords. Write down your passwords, and keep them in a safe place.

## Windows passwords

### Change my Windows password

**Problem:** How to change my Windows password?

**Solution:** To change your Windows password, take the following steps:

1. Type **Sign-in options** in the Windows search box and press Enter.
2. Select **Password → Change** and follow on-screen instructions to change the password.

If the problem persists, do not hesitate to call Lenovo Customer Center. For the latest Lenovo Support phone numbers for your country or region, go to <https://pcsupport.lenovo.com/supportphonenumber>.

### Reset my Windows password

**Problem:** How to reset my Windows password?

**Solution:** To reset your Windows password, choose one of the following solutions:

- If you have set security questions, take the following steps:
  1. Click **Reset password** on the sign-in screen after you have entered an incorrect password.

**Note:** Contact your administrator if you do not see an option to reset your password.
  2. Follow on-screen instructions to reset a new password.
- If you have created a password reset disk, take the following steps:
  1. Connect a password reset disk to a USB-compatible connector on your computer.
  2. Follow on-screen instructions to reset your password.
- If you have an administrator account take the following steps:
  1. Sign in to your computer with the local administrator account.
  2. Follow on-screen instructions to reset your password.

If the problem persists, do not hesitate to call Lenovo Customer Center. For the latest Lenovo Support phone numbers for your country or region, go to <https://pcsupport.lenovo.com/supportphonenumber>.

### Retrieve my BitLocker recovery key in Windows

**Problem:** How to retrieve my BitLocker recovery key in Windows?

**Solution:** To retrieve your BitLocker recovery key in Windows, choose one of the following solutions:

- In your Microsoft account:
  1. Open a web browser on any device such as mobile phone with internet access.
  2. Sign into your Microsoft account at <https://account.microsoft.com/devices/recoverykey>.

3. Follow on-screen instructions to find the recovery key.
- On a printed paper:  
Find out the paper with the record of BitLocker recovery information if you have printed or recorded the recovery key on the paper.
  - On a USB flash drive:
    1. Connect the USB flash drive into a USB-compatible connector on your computer.
    2. Follow the on-screen instructions to find the recovery key.
  - By your administrator:  
Contact your administrator to have the recovery key if your computer is connected to a domain or signed into an organization using a work or school e-mail account.

For more details, go to <https://support.microsoft.com/windows/finding-your-bitlocker-recovery-key-in-windows>.

If the problem persists, do not hesitate to call Lenovo Customer Center. For the latest Lenovo Support phone numbers for your country or region, go to <https://pcsupport.lenovo.com/supportphonenumber>.

---

## Power management

To reduce power consumption, the computer has two power management modes: sleep and hibernation.

### Sleep mode

When the computer enters sleep mode, the screen goes blank and all internal devices are still powered on with lower power consumption.

To enter sleep mode, press Fn+4 or open the Start menu.

In certain circumstances, the computer goes into sleep mode automatically:

- After a period of inactivity specified in power plan settings
- When the battery power is low

To resume the computer from sleep mode, press the power button.

Also, in either of the following events, the computer automatically returns from sleep mode and resumes operation:

- The ring indicator (RI) is signaled by a serial device or a PC Card device.
- The time set on the resume timer elapses.

**Note:** The computer does not accept any input immediately after it enters sleep mode. Wait a few seconds before taking any action to reenter operation mode.

### Hibernation mode

In hibernation mode, the following occurs:

- The system status, RAM, VRAM, and setup data are stored on the solid-state drive.
- The system is powered off.

**Note:** If the computer enters the hibernation mode while it is connected to the dock, do not disconnect it before resuming normal operation. If you do disconnect it and then try to resume normal operation, you will get an error message, and you will have to restart the system.

If you have defined one of the following actions as the event that causes the system to go into hibernation mode, perform that action.

- Closing the lid.
- Pressing the power button.

Also, the computer goes into hibernation mode automatically after a period of inactivity specified in power plan settings.

When the power is turned on, the computer returns from hibernation mode and resumes operation. The hibernation file in the boot record on the solid-state drive is read, and system status is restored from the solid-state drive.

---

## Appendix A. Notice for USB connector name update

The USB Implementers Forum published a revision of the guideline for USB connector names in September, 2022. Lenovo follows the revised guideline and updates USB connector names accordingly. You can refer to the table below for naming update details.

<b>Current name</b>	<b>Previous name</b>
USB-A connector (Hi-Speed USB)	USB-A 2.0 connector
USB-A connector (USB 5Gbps)	USB-A 3.2 Gen 1 connector
USB-A connector (USB 10Gbps)	USB-A 3.2 Gen 2 connector
USB-A connector (USB 5Gbps, Always On USB)	Always on USB-A 3.2 Gen 1 connector
USB-A connector (USB 10Gbps, Always On USB)	Always on USB-A 3.2 Gen 2 connector
USB-C connector (USB 5Gbps)	USB-C (3.2 Gen 1) connector
USB-C connector (USB 10Gbps)	USB-C (3.2 Gen 2) connector
USB-C connector (USB 20Gbps)	USB 3.2 Gen 2x2
USB-C connector (USB4 20Gbps)	USB 4 Gen 2x2
USB-C connector (USB4 40Gbps)	USB-C (USB 4) connector
USB-C connector (Thunderbolt 3)	USB-C (Thunderbolt 3) connector
USB-C connector (Thunderbolt 4)	USB-C (Thunderbolt 4) connector

---

## Appendix B. Self-help resource

Find more information about your device through the following self-help resources.

### Product information

- Product specifications: <https://psref.lenovo.com>
- Technical specifications for Lenovo workstations: <https://thinkstation-specs.com>

### Lenovo Support resource

- Lenovo PC Technical Support web site: <https://pcsupport.lenovo.com>. You can obtain the following information and resources:
  - Drivers and software
  - Troubleshoot and diagnose
  - How to's
  - Guides and manuals
  - Warranty lookup
  - Parts lookup
  - Accessories
  - Contact us
  - Repair status check
  - Imaging and security resources
  - Glossary
- Lenovo Support phone numbers: <https://pcsupport.lenovo.com/supportphonenumber>. You can seek assistance in obtaining or installing any software, drivers, and UEFI BIOS downloads.
- Vantage app: Type vantage in the Windows search box. You can use the app to:
  - Configure device settings
  - Download and install UEFI BIOS, drivers, and firmware updates
  - Secure your device from outside threats
  - Diagnose hardware problems
  - Check the warranty status of your device
  - Access *User Guide* and helpful articles
- Lenovo communities:
  - Forums: <https://forums.lenovo.com>
  - Legion Gaming Community: <https://gaming.lenovo.com>
  - Lenovo EDU Community: <https://education.lenovo.com>
  - Lenovo Pro Community: <https://smbcommunity.lenovo.com>
- Troubleshooting tips: <https://www.lenovo.com/tips>

### Service information

- Warranty lookup: <https://support.lenovo.com/warranty-lookup>. You can check the warranty status of your device.

- Repair status check: <https://support.lenovo.com/track-repair-status>. You can check the repair status of your device by repair ticket, serial number, or IMEI number.
- Parts lookup and purchase: <https://support.lenovo.com/parts-lookup>. You can find service parts by serial number or machine type.
- Lenovo BIOS Simulation Center: <https://download.lenovo.com/bsco/index.html>. You can explore the BIOS settings of your device.
- Additional services purchase: <https://pcsupport.lenovo.com/warrantyupgrade>. You can protect your device with extended warranty, Accidental Damage Protection, Premium Care & Support, and Vantage Smart Performance.
- System disassembly/reassembly videos: <https://support.lenovo.com/us/en/solutions/ht505031>. You can find system disassembly or reassembly videos that show the CRU/FRU removals or replacements for the Lenovo authorized service technicians.

## Product documentation

Documentation title	Information included	How to Access
<i>Setup Guide</i>	Initial setup and overview information	<ul style="list-style-type: none"> <li>• Access the printed version from the product package.</li> <li>• Go to <a href="https://pcsupport.lenovo.com">https://pcsupport.lenovo.com</a> and search by the product name or serial number. Then, click <b>Guides &amp; Manuals</b>.</li> </ul>
<i>User Guide</i>	Instructions, guidance, resources, and contact information	<ul style="list-style-type: none"> <li>• Scan the QR code in <i>Setup Guide</i>.</li> <li>• In Windows Start menu, click <b>User Guide</b> .</li> <li>• Type vantage in the Windows search box and press Enter. Then, find the <i>User Guide</i> in the app.</li> <li>• Go to <a href="https://pcsupport.lenovo.com">https://pcsupport.lenovo.com</a> and search by the product name or serial number. Then, click <b>Guides &amp; Manuals</b>.</li> </ul>
<i>Hardware Maintenance Manual</i>	Hardware diagnostic and replacement information for technicians	Go to <a href="https://pcsupport.lenovo.com">https://pcsupport.lenovo.com</a> and Search by the product name or serial number. Then, click <b>Guides &amp; Manuals</b> .

## Operating system support resource

- Windows help information
  - Type get help in the Windows search box
  - Use Windows Search or the Cortana® personal assistant
  - Microsoft Support Web site: <https://support.microsoft.com>
- Reset or restore Windows
  - Use Lenovo recovery options: <https://support.lenovo.com/HowToCreateLenovoRecovery>
  - Use Windows recovery options: Go to <https://pcsupport.lenovo.com> and search by the product name or serial number. Then, navigate to the troubleshooting menu to diagnose the operating system for recovery instructions.

## Accessory information

- Purchase accessories: <https://www.lenovo.com/accessories>
- Service recommendation and accessory configurator: <https://smartfind.lenovo.com>
- Accessories and option compatibility matrix: <https://www.lenovo.com/accessoriesguide>

## Legal and compliance information

- Product compliance: <https://www.lenovo.com/compliance>
- Legal information: <https://www.lenovo.com/us/en/legal>
- Regulatory documentation: Go to <https://pcsupport.lenovo.com> and search by the product name or serial number. Then, click **Guides & Manuals**.
  - *Safety and Warranty Guide*: Safety, warranty, recycling, and other information
  - *Generic Safety and Compliance Notices*: Compliance, accessibility, RoHS, and other information
  - *Regulatory Notice*: Regulatory notices for wireless modules

## Lenovo responsibility

- Accessibility information: <https://www.lenovo.com/accessibility>
- Environment information: <https://www.lenovo.com/us/en/sustainability-operational-impact>
- Product security: <https://www.lenovo.com/us/en/product-security/landing/>

---

## Appendix C. Important notice for Quebec consumers

In regard to section 79.18 of Quebec's Regulation respecting the application of the Consumer Protection Act, Lenovo in no way guarantees the availability of (a) replacement parts; (b) repair services; and (c) information necessary to maintain or repair the goods. For up-to-date information on the technical support and parts available for your purchase, please consult <https://support.lenovo.com/ca/en>.

En ce qui concerne l'article 79.18 du Règlement d'application de la Loi sur la protection du consommateur du Québec, Lenovo ne garantit en aucune façon la disponibilité des éléments suivants : (a) les pièces de rechange; (b) les services de réparation; et (c) les renseignements nécessaires à l'entretien à la réparation du bien. Pour obtenir des renseignements à jour sur le soutien technique et les pièces disponibles pour votre achat, veuillez consulter <https://support.lenovo.com/ca/fr>.

---

## Appendix D. Notices and trademarks

### Notices

Lenovo may not offer the products, services, or features discussed in this document in all countries. Consult your local Lenovo representative for information on the products and services currently available in your area. Any reference to a Lenovo product, program, or service is not intended to state or imply that only that Lenovo product, program, or service may be used. Any functionally equivalent product, program, or service that does not infringe any Lenovo intellectual property right may be used instead. However, it is the user's responsibility to evaluate and verify the operation of any other product, program, or service.

Lenovo may have patents or pending patent applications covering subject matter described in this document. The furnishing of this document does not give you any license to these patents. You can send license inquiries, in writing, to:

*Lenovo (United States), Inc.  
8001 Development Drive  
Morrisville, NC 27560  
U.S.A.  
Attention: Lenovo Director of Licensing*

LENOVO PROVIDES THIS PUBLICATION "AS IS" WITHOUT WARRANTY OF ANY KIND, EITHER EXPRESS OR IMPLIED, INCLUDING, BUT NOT LIMITED TO, THE IMPLIED WARRANTIES OF NON-INFRINGEMENT, MERCHANTABILITY OR FITNESS FOR A PARTICULAR PURPOSE. Some jurisdictions do not allow disclaimer of express or implied warranties in certain transactions, therefore, this statement may not apply to you.

This information could include technical inaccuracies or typographical errors. Changes are periodically made to the information herein; these changes will be incorporated in new editions of the publication. Lenovo may make improvements and/or changes in the product(s) and/or the program(s) described in this publication at any time without notice.

The products described in this document are not intended for use in implantation or other life support applications where malfunction may result in injury or death to persons. The information contained in this document does not affect or change Lenovo product specifications or warranties. Nothing in this document shall operate as an express or implied license or indemnity under the intellectual property rights of Lenovo or third parties. All information contained in this document was obtained in specific environments and is presented as an illustration. The result obtained in other operating environments may vary.

Lenovo may use or distribute any of the information you supply in any way it believes appropriate without incurring any obligation to you.

Any references in this publication to non-Lenovo Web sites are provided for convenience only and do not in any manner serve as an endorsement of those Web sites. The materials at those Web sites are not part of the materials for this Lenovo product, and use of those Web sites is at your own risk.

Any performance data contained herein was determined in a controlled environment. Therefore, the result obtained in other operating environments may vary significantly. Some measurements may have been made on development-level systems and there is no guarantee that these measurements will be the same on generally available systems. Furthermore, some measurements may have been estimated through extrapolation. Actual results may vary. Users of this document should verify the applicable data for their specific environment.

## Trademarks

Lenovo, Lenovo logo, ThinkPad, ThinkPad logo, and UltraConnect are trademarks of Lenovo. Intel and Thunderbolt are trademarks of Intel Corporation or its subsidiaries in the U.S. and/or other countries. Microsoft, Microsoft Teams, Windows, BitLocker, , and Cortana are trademarks of the Microsoft group of companies. The terms HDMI and HDMI High-Definition Multimedia Interface are trademarks or registered trademarks of HDMI Licensing LLC in the United States and other countries. USB-C® is the registered trademark of USB Implementers Forum. All other trademarks are the property of their respective owners.

---

## Appendix E. Abbreviation table

The following table lists all abbreviations used in this manual.

Abbreviation	Term
BGA	Ball Grid Array
CMOS	Complementary Metal Oxide Semiconductor
CMV	Custom Model Variant
CRC	Cyclic redundancy check
CRT	Cathode ray tube
CRU	Customer Replaceable Unit
CTO	Configure To Order
EAIA	Enhanced Asset Information Area
EEPROM	Electrically Erasable Programmable Read-Only Memory
EFI	Extensible Firmware Interface
ESD	Electrostatic discharge
FRU	Field Replaceable Unit
GAV	General Announce Variant
IC	Integrated circuits
LCD	Liquid Crystal Display
MTM	Machine type and model
POST	Power-on self-test
RFID	Radio-frequency identification
SVP	Supervisor password
UUID	Universally unique identifier



Part Number: SP41N08392

Printed in China

(1P) P/N: SP41N08392

