

Hardware Maintenance Manual

Lenovo
ThinkBook

Lenovo

Lenovo ThinkBook 14 Gen 9 and Lenovo ThinkBook 16 Gen 9

First Edition (January 2026)

© Copyright Lenovo 2026.

LIMITED AND RESTRICTED RIGHTS NOTICE: If data or software is delivered pursuant to a General Services Administration "GSA" contract, use, reproduction, or disclosure is subject to restrictions set forth in Contract No. GS-35F-05925.

Contents

About this manual	ii
------------------------------------	-----------

Chapter 1. Safety requirements for hardware maintenance	1
--	----------

General safety requirements	1
Electrical safety requirements	1
Safety inspection guide	3
Handling devices that are sensitive to electrostatic discharge	3
Important danger warning in multiple languages	4

Chapter 2. Diagnostics and troubleshooting	17
---	-----------

Diagnostics applications	17
Hardware scan in Vantage	17
UEFI diagnostics application	18
Advanced diagnostics application (Windows version)	18
Advanced diagnostics application (bootable versions for Linux/UEFI)	18
Call Lenovo	19
Before you contact Lenovo	19
Lenovo Customer Support Center	19
Nonwarranted items and activities	20

Chapter 3. Parts, screws, and tools	21
--	-----------

Parts	21
Part type definition	21
Look up a part	22
Exploded view and part list	22
Screws	24
Screw list	25
Screw notices	25
Service tools	26

Chapter 4. Hardware replacement	30
--	-----------

General guidelines	30
Connectors and cables for replacement	30
Lower case	32
Label locations	33
Battery pack	35
Touchpad board cable	38
Touchpad board cable (14-inch models)	38
Touchpad board cable (16-inch models)	39
Memory module	40
Heat sink	41

Heat sink (14-inch models)	41
Heat sink (16-inch models)	43
Handling thermal interface materials	45
Fan	46
Fan (14-inch models)	46
Fan (16-inch models)	47
M.2 solid-state drive	49
Wi-Fi card	50
CMOS battery	51
Speakers	52
I/O bracket	53
System board	55
System board (14-inch models)	55
System board (16-inch models)	56
Write key product information to a replacement system board	58
I/O board	59
I/O board (14-inch models)	59
I/O board (16-inch models)	61
Power button (for selected models)	63
Power button (14-inch models)	63
Power button (16-inch models)	64
Fingerprint sensor board (for selected models)	64
Fingerprint sensor board (14-inch models)	64
Fingerprint sensor board (16-inch models)	65
LCD module	66
LCD Module (14-inch models)	66
LCD Module (16-inch models)	68
LCD Self Test	70
Upper case (with keyboard)	70
Disassemble the LCD module	70
Hinge cover	70
LCD bezel	71
Hinges	72
Mic rubbers	73
LCD panel	74
Antennas	75
Camera board	76
EDP cable	77
LCD cover	78

Appendix A. Important notice for Quebec consumers	79
--	-----------

Appendix B. Self-help resources	80
--	-----------

Trademarkslxxxii
----------------------	---------

About this manual

This manual contains hardware maintenance instructions for the products listed in the following table. In this manual, you will read safety requirements for hardware maintenance, diagnostics and troubleshooting, hardware replacement instructions, and other reference information. Use the manual along with the diagnostics applications and service tools to troubleshoot problems effectively.

Model name	Machine type (MT)
ThinkBook 14 G9 AHP	21V0
ThinkBook 14 G9 AHP 1	
ThinkBook 14 G9 AHP 2	
ThinkBook 14 G9 IPL	21UX
ThinkBook 14 G9 IPL 1	
ThinkBook 14 G9 IPL 2	
ThinkBook 14 G9 IRL	21UY
ThinkBook 14 G9 IRL 1	
ThinkBook 14 G9 IRL 2	
ThinkBook 16 G9 AHP	21UT
ThinkBook 16 G9 AHP 1	
ThinkBook 16 G9 AHP 2	
ThinkBook 16 G9 IPL	21UR
ThinkBook 16 G9 IPL 1	
ThinkBook 16 G9 IPL 2	
ThinkBook 16 G9 IRL	21US
ThinkBook 16 G9 IRL 1	
ThinkBook 16 G9 IRL 2	

Important:

- Hardware configurations and software programs vary by machine type. Some statements or illustrations in this manual might be slightly different from your computer.
- It is recommended that the computer be repaired by trained service technicians.
- For customers electing to service the computer on their own, it is still recommended to speak to our Customer Support Center so that you can be directed to the correct documentation and repair information. See “Call Lenovo” on page 19. Depending on the complexity of the repair, it may be recommended to have a Lenovo-authorized service provider repair your computer.
- Before servicing a computer, please follow all instructions carefully and be sure to read all the information under Chapter 1 “Safety requirements for hardware maintenance” on page 1 and “General guidelines” on page 30.

Chapter 1. Safety requirements for hardware maintenance

This chapter presents the following safety information that you need to be familiar with before you service a Lenovo notebook computer.

General safety requirements

Meet the following requirements on environment, personnel and outfit, and operation to ensure general safety:

Environment requirements

Observe good housekeeping in the area of the machines during and after maintenance.

Personnel and outfit requirements

- Do not wear loose clothing that can be trapped in the moving parts of a machine. Make sure that your sleeves are fastened or rolled up above your elbows. If your hair is long, fasten it.
- Insert the ends of your necktie or scarf inside clothing or fasten it with a non-conductive clip, about 8 centimeters (3 inches) from the end.
- Do not wear jewelry, chains, metal-frame eyeglasses, or metal fasteners for your clothing.

Attention: Metal objects are good electrical conductors.

- Wear safety glasses when you are hammering, drilling, soldering, cutting wire, attaching springs, using solvents, or working in any other conditions that might be hazardous to your eyes.

Operation requirements

- Before you start the machine, make sure that no one is in a hazardous position.
- Do not perform any action that causes personal injury, or that makes the equipment unsafe.
- Keep your tool case away from walk areas so that other people will not trip over it.
- When lifting any heavy object:
 1. Make sure that you can stand safely without slipping.
 2. Distribute the weight of the object equally between your feet.
 3. Use a slow lifting force. Never move suddenly or twist when you attempt to lift.
 4. Lift by standing or by pushing up with your leg muscles; this action removes the strain from the muscles in your back. Do not attempt to lift any object that weighs more than 16 kg (35 lb) or that you think is too heavy for you.
- Place removed covers and other parts in a safe place, away from all personnel, while you are servicing the machine.
- After service, reinstall all safety shields, guards, labels, and ground wires. Replace any safety device that is worn or defective. Reinstall all covers correctly.
- Fan louvers on the machine help to prevent overheating of internal components. Do not obstruct fan louvers or cover them with labels or stickers.

Electrical safety requirements

To ensure electrical safety, meet the following requirements on environment, outfit, and operation when working on the computer:

Environment requirements

- Find the room emergency power-off (EPO) switch, disconnecting switch, or electrical outlet. If an electrical accident occurs, you can then operate the switch or unplug the power cord quickly.
- Do not work alone under hazardous conditions or near equipment that has hazardous voltages.

- Always look carefully for possible hazards in your work area. Examples of these hazards are moist floors, non-grounded power extension cables, power surges, and missing safety grounds.

Outfit requirements

- Do not use worn or broken tools and testers.
- Regularly inspect and maintain your electrical hand tools for safe operational condition.

Important:

- Use only approved tools and test equipment. Some hand tools have handles covered with a soft material that does not insulate you when working with live electrical currents.
- Many customers have, near their equipment, rubber floor mats that contain small conductive fibers to decrease electrostatic discharges. Do not use this type of mat to protect yourself from electrical shock.

Operation requirements

- Disconnect all power before:
 - Performing a mechanical inspection
 - Working near power supplies
 - Removing or installing main units
- Do not service the following parts with the power on when they are removed from their normal operating places in a machine:
 - Power supply units
 - Pumps
 - Blowers and fans
 - Motor generators
 - Similar units as listed above
 This practice ensures correct grounding of the units.
- Electrical grounding of the computer is required for operator safety and correct system function. Proper grounding of the electrical outlet can be verified by a certified electrician.
- Observe the special safety precautions when you work with very high voltages; Instructions for these precautions are in the safety sections of maintenance information. Use extreme care when measuring high voltages.
- Before you start to work on the machine, unplug the power cord. If you cannot unplug it, ask the customer to power-off the wall box that supplies power to the machine, and to lock the wall box in the off position.
- Never assume that power has been disconnected from a circuit. First, check that it has been powered off.
- Do not touch live electrical circuits with the reflective surface of a plastic dental mirror. The surface is conductive; such touching can cause personal injury and machine damage.
- If you need to work on a machine that has exposed electrical circuits, observe the following precautions:
 - Ensure that another person, familiar with the power-off controls, is near you.

Attention: Another person must be there to switch off the power, if necessary.

- Use only one hand when working with powered-on electrical equipment; keep the other hand in your pocket or behind your back.

Attention: An electrical shock can occur only when there is a complete circuit. By observing the above rule, you may prevent a current from passing through your body.

- When using testers, set the controls correctly and use the approved probe leads and accessories for that tester.
- Stand on suitable rubber mats (obtained locally, if necessary) to insulate you from grounds such as metal floor strips and machine frames.
- If an electrical accident occurs:
 - Use caution; do not become a victim yourself.
 - Switch off power.
 - Send another person to get medical aid.

Safety inspection guide

The purpose of this inspection guide is to assist you in identifying potentially unsafe conditions. As each machine was designed and built, required safety items were installed to protect users and service technicians from injury. This guide addresses only those items. You should use good judgment to identify potential safety hazards due to attachment of non-Lenovo features or options not covered by this inspection guide.

If any unsafe conditions are present, you must determine how serious the apparent hazard could be and whether you can continue without first correcting the problem.

Consider these conditions and the safety hazards they present:

- Electrical hazards, especially primary power (primary voltage on the frame can cause serious or fatal electrical shock)
- Explosive hazards, such as a damaged cathode ray tube (CRT) face or a bulging capacitor
- Mechanical hazards, such as loose or missing hardware

To determine whether there are any potentially unsafe conditions, use the following checklist at the beginning of every service task. Begin the checks with the power off, and the power cord disconnected.

Checklist:

1. Check exterior covers for damage (loose, broken, or sharp edges).
2. Power off the computer. Disconnect the power cord.
3. Check the power cord for:
 - a. A third-wire ground connector is in good condition. Use a meter to measure third-wire ground continuity for 0.1 ohm or less between the external ground pin and the frame ground.
 - b. The power cord should be the authorized type specified for your computer. Go to: <http://www.lenovo.com/serviceparts-lookup>
 - c. Insulation must not be frayed or worn.
4. Check for cracked or bulging batteries.
5. Remove the cover.
6. Check for any obvious non-Lenovo alterations. Use good judgment as to the safety of any non-Lenovo alterations.
7. Check inside the unit for any obvious unsafe conditions, such as metal filings, contamination, water or other liquids, or signs of fire or smoke damage.
8. Check for worn, frayed, or pinched cables.
9. Check that the power-supply cover fasteners (screws or rivets) have not been removed or tampered with.

Handling devices that are sensitive to electrostatic discharge

Any computer part containing transistors or integrated circuits (ICs) should be considered sensitive to electrostatic discharge (ESD). ESD damage can occur when there is a difference in charge between objects. Protect against ESD damage by equalizing the charge so that the machine, the part, the work mat, and the person handling the part are all at the same charge.

Notes:

1. Use product-specific ESD procedures when they exceed the requirements noted here.
2. Ensure that the ESD protective devices you use have been certified (ISO 9000) as fully effective.

When handling ESD-sensitive parts:

- Keep the parts in protective packages until they are inserted into the product.
- Avoid contact with other people.
- Wear a grounded wrist strap against your skin to eliminate static on your body.
- Prevent the part from touching your clothing. Most clothing is insulative and retains a charge even when you are wearing a wrist strap.

- Use a grounded work mat to provide a static-free work surface. The mat is especially useful when handling ESD-sensitive devices.
- Select a grounding system, such as those listed below, to provide protection that meets the specific service requirement.

Note: The use of a grounding system to guard against ESD damage is desirable but not necessary.

- Attach the ESD ground clip to any frame ground, ground braid, or green-wire ground.
- When working on a double-insulated or battery-operated system, use an ESD common ground or reference point. You can use coax or connector-outside shells on these systems.
- Use the round ground prong of the ac plug on ac-operated computers.

Important danger warning in multiple languages

The safety notices in this section are provided in the following languages:

- English
- Arabic
- Brazilian Portuguese
- French
- German
- Hebrew
- Japanese
- Korean
- Spanish
- Traditional Chinese

English



DANGER

Before the computer is powered on after FRU replacement, make sure that all screws, springs, and other small parts are in place and are not left loose inside the computer. Verify this by shaking the computer and listening for rattling sounds. Metallic parts or metal flakes can cause electrical short circuits.



DANGER

Some standby batteries contain a small amount of nickel and cadmium. Do not disassemble a standby battery, recharge it, throw it into fire or water, or short-circuit it. Dispose of the battery as required by local ordinances or regulations. Use only the battery in the appropriate parts listing. Use of an incorrect battery can result in ignition or explosion of the battery.



DANGER

The battery pack contains small amounts of nickel. Do not disassemble it, throw it into fire or water, or short-circuit it. Dispose of the battery pack as required by local ordinances or regulations. Use only the battery in the appropriate parts listing when replacing the battery pack. Use of an incorrect battery can result in ignition or explosion of the battery.



DANGER

The lithium battery can cause a fire, an explosion, or a severe burn. Do not recharge it, remove its polarized connector, disassemble it, heat it above 100°C (212°F), incinerate it, or expose its cell contents to water. Dispose of the battery as required by local ordinances or regulations. Use only the battery in the appropriate parts listing. Use of an incorrect battery can result in ignition or explosion of the battery.



DANGER

If the LCD breaks and the fluid from inside the LCD gets into your eyes or on your hands, immediately wash the affected areas with water for at least 15 minutes. Seek medical care if any symptoms from the fluid are present after washing.



DANGER

To avoid shock, do not remove the plastic cover that protects the lower part of the inverter card.



DANGER

Though the main batteries have low voltage, a short-circuited or grounded battery can produce enough current to burn personnel or combustible materials.



DANGER

Unless hot swap is allowed for the FRU being replaced, do as follows before removing it: power off the computer, unplug all power cords from electrical outlets, remove the battery pack, and disconnect any interconnecting cables.

Arabic



قبل إعادة تشغيل الحاسب بعد الانتهاء من استبدال FRU، تأكد من أنه قد تم إعادة كل من المسامير و السوست وكل الأجزاء الصغيرة الأخرى في أماكنهم ولم يتم فقدم داخل الحاسب. ويمكن التحقق من ذلك عن طريق هز الحاسب والاستماع لأي صوت صاخب يصدر منه. قد تؤدي الأجزاء أو الرقائق المعدنية إلى حدوث دائرة قصر.



تحتوي بعض البطاريات الاحتياطية على كمية صغيرة من مادتي النيكل والكادميوم. لا تقم بفك أو إعادة شحن البطارية الاحتياطية ولا تقم أيضا بالقاءها في النار أو الماء ولا تتسبب في احداث دائرة قصر بها. قم بالتخلص من البطارية كما هو موضح في القوانين المحلية. استخدم نوع البطارية المحدد والذي يوصى باستخدامه. حيث أنه قد يؤدي استخدام نوع بطارية غير صحيح الى اشتعالها أو انفجارها.



تحتوي حزمة البطارية على كمية صغيرة من مادة النيكل. لا تقم بفكها أو القاءها في النار أو الماء ولا تتسبب في احداث دائرة قصر بها. تخلص من حزمة البطارية وفقا لما هو موضح في القوانين المحلية. قم، عند استبدال حزمة البطارية، باستخدام الأنواع المحددة فقط والتي يوصى باستخدامها. حيث أنه قد يؤدي استخدام نوع بطارية غير صحيح الى اشتعالها أو انفجارها.



قد تتسبب بطارية الليثيوم في حدوث حريق أو انفجار أو حدوث حروق شديدة. لا تقم بإعادة شحن البطارية أو إزالة موصل الاستقطاب الخاص بها ولا تحاول أيضا فكها أو تسخينها لأكثر من ١٠٠ درجة مئوية (٢١٢ فهرنهايت) أو حرقها أو تعريض محتويات الخانة الخاصة بها للماء. قم بالتخلص من البطارية وفقا لما هو موضح في القوانين المحلية. استخدم نوع البطارية المحدد والذي يوصى باستخدامه. حيث أنه قد يؤدي استخدام نوع بطارية غير صحيح الى اشتعالها أو انفجارها.



إذا ما انكسرت شاشة LCD ولامس السائل الداخلي عينيك أو يديك، قم في الحال بغسلها بالماء لمدة لا تقل عن ١٥ دقيقة. إذا ما وجدت أي أعراض بعد الغسل اطلب عندئذ المساعدة الطبية.



لتجنب التعرض لأي صدمات، لا تقم بإزالة الغطاء البلاستيكي الذي يحمي الجزء الأسفل من بطاقة العاكس.



على الرغم من أن البطاريات الرئيسية يكون لها جهد منخفض، إلا أنه قد تقوم البطاريات التي حدث قصور بها أو التي تم توصيلها أرضيا بإصدار تيار يكفي لحدوث حروق للأفراد أو تعرض المواد القابلة للاشتعال للحريق.



ما لم يتم السماح بالتبديل الفوري لأي FRU الجاري استبداله بدون ضرورة اغلاق النظام، قم بتنفيذ ما يلي قبل ازالته. قم بإيقاف تشغيل الحاسب ونزع كل أسلاك الطاقة من المخارج الكهربائية وقم أيضا بإزالة حزمة البطارية ثم قم بفصل أي كابلات متصلة.

Brazilian Portuguese



PERIGO

Antes de ligar o computador após a substituição da FRU, certifique-se de que todos os parafusos, molas e outras peças pequenas estejam no lugar e não estejam soltos dentro do computador. Verifique isso sacudindo o computador e procurando ouvir sons de peças soltas. Peças metálicas ou lascas de metal podem causar curto-circuito.



PERIGO

Algumas baterias reserva contêm uma pequena quantidade de níquel e cádmio. Não desmonte uma bateria reserva, recarregue-a, jogue-a no fogo ou na água, ou deixe-a entrar em curto-circuito. Descarte a bateria conforme requerido pelas leis ou regulamentos locais. Use somente a bateria nas partes listadas apropriadas. O uso de uma bateria incorreta pode resultar em combustão ou explosão da bateria.



PERIGO

O pacote da bateria contém uma pequena quantidade de níquel. Não o desmonte, jogue-o no fogo ou na água, ou deixe-o entrar em curto-circuito. Descarte o pacote da bateria conforme requerido pelas leis ou regulamentos locais. Use somente a bateria nas partes listadas apropriadas ao substituir o pacote da bateria. O uso de uma bateria incorreta pode resultar em combustão ou explosão da bateria.



PERIGO

A bateria de lítio pode causar incêndio, explosão ou graves queimaduras. Não a recarregue, remova seu conector polarizado, desmonte-a, aqueça-a acima de 100°C (212°F), incinere-a, ou exponha o conteúdo de sua célula à água. Descarte a bateria conforme requerido pelas leis ou regulamentos locais. Use somente a bateria nas partes listadas apropriadas. O uso de uma bateria incorreta pode resultar em combustão ou explosão da bateria.



PERIGO

Se o LCD quebrar e o fluido de dentro dele entrar em contato com seus olhos ou com suas mãos, lave as áreas afetadas imediatamente com água durante pelo menos 15 minutos. Procure cuidados médicos se algum sintoma causado pelo fluido surgir após a lavagem.



PERIGO

Para evitar choque elétrico, não remova a capa plástica que protege a parte inferior da placa inversora.



PERIGO

Embora as principais baterias possuam baixa voltagem, uma bateria em curto-circuito ou aterrada pode produzir corrente o bastante para queimar materiais de pessoal ou inflamáveis.



PERIGO

A menos que uma hot swap seja permitida para a FRU que está sendo substituída, faça o seguinte antes de removê-la: desligue o computador, desconecte todos os cabos de energia das tomadas, remova o pacote de baterias e desconecte quaisquer cabos de interconexão.

French



DANGER

Avant de remettre l'ordinateur sous tension après remplacement d'une unité en clientèle, vérifiez que tous les ressorts, vis et autres pièces sont bien en place et bien fixées. Pour ce faire, secouez l'unité et assurez-vous qu'aucun bruit suspect ne se produit. Des pièces métalliques ou des copeaux de métal pourraient causer un court-circuit.



DANGER

Certaines batteries de secours contiennent du nickel et du cadmium. Ne les démontez pas, ne les rechargez pas, ne les exposez ni au feu ni à l'eau. Ne les mettez pas en court-circuit. Pour les mettre au rebut, conformez-vous à la réglementation en vigueur. Lorsque vous remplacez la pile de sauvegarde ou celle de l'horloge temps réel, veillez à n'utiliser que les modèles cités dans la liste de pièces détachées adéquate. Une batterie ou une pile inappropriée risque de prendre feu ou d'exploser.



DANGER

La batterie contient du nickel. Ne la démontez pas, ne l'exposez ni au feu ni à l'eau. Ne la mettez pas en court-circuit. Pour la mettre au rebut, conformez-vous à la réglementation en vigueur. Lorsque vous remplacez la batterie, veillez à n'utiliser que les modèles cités dans la liste de pièces détachées adéquate. En effet, une batterie inappropriée risque de prendre feu ou d'exploser.



DANGER

La pile de sauvegarde contient du lithium. Elle présente des risques d'incendie, d'explosion ou de brûlures graves. Ne la rechargez pas, ne retirez pas son connecteur polarisé et ne la démontez pas. Ne l'exposez pas à une température supérieure à 100°C, ne la faites pas brûler et n'en exposez pas le contenu à l'eau. Mettez la pile au rebut conformément à la réglementation en vigueur. Une pile inappropriée risque de prendre feu ou d'exploser.



DANGER

Si le panneau d'affichage à cristaux liquides se brise et que vous recevez dans les yeux ou sur les mains une partie du fluide, rincez-les abondamment pendant au moins quinze minutes. Consultez un médecin si des symptômes persistent après le lavage.



DANGER

Afin d'éviter tout risque de choc électrique, ne retirez pas le cache en plastique protégeant la partie inférieure de la carte d'alimentation.



DANGER

Bien que le voltage des batteries principales soit peu élevé, le court-circuit ou la mise à la masse d'une batterie peut produire suffisamment de courant pour brûler des matériaux combustibles ou causer des brûlures corporelles graves.



DANGER

Si le remplacement à chaud n'est pas autorisé pour l'unité remplaçable sur site que vous remplacez, procédez comme suit avant de retirer l'unité : mettez l'ordinateur hors tension, débranchez tous les cordons d'alimentation des prises de courant, retirez le bloc de batterie et déconnectez tous les câbles d'interconnexion.

German



VORSICHT

Bevor nach einem FRU-Austausch der Computer wieder angeschlossen wird, muß sichergestellt werden, daß keine Schrauben, Federn oder andere Kleinteile fehlen oder im Gehäuse vergessen wurden. Der Computer muß geschüttelt und auf Klappergeräusche geprüft werden. Metallteile oder-splitter können Kurzschlüsse erzeugen.



VORSICHT

Die Bereitschaftsbatterie, die sich unter dem Diskettenlaufwerk befindet, kann geringe Mengen Nickel und Cadmium enthalten. Sie darf nur durch die Verkaufsstelle oder den IBM Kundendienst ausgetauscht werden. Sie darf nicht zerlegt, wiederaufgeladen, kurzgeschlossen, oder Feuer oder Wasser ausgesetzt werden. Die Batterie kann schwere Verbrennungen oder Verätzungen verursachen. Bei der Entsorgung die örtlichen Bestimmungen für Sondermüll beachten. Beim Ersetzen der Bereitschafts- oder Systembatterie nur Batterien des Typs verwenden, der in der Ersatzteilliste aufgeführt ist. Der Einsatz falscher Batterien kann zu Entzündung oder Explosion führen.



VORSICHT

Akkus enthalten geringe Mengen von Nickel. Sie dürfen nicht zerlegt, wiederaufgeladen, kurzgeschlossen, oder Feuer oder Wasser ausgesetzt werden. Bei der Entsorgung die örtlichen Bestimmungen für Sondermüll beachten. Beim Ersetzen der Batterie nur Batterien des Typs verwenden, der in der Ersatzteilliste aufgeführt ist. Der Einsatz falscher Batterien kann zu Entzündung oder Explosion führen.



VORSICHT

Die Systembatterie ist eine Lithiumbatterie. Sie kann sich entzünden, explodieren oder schwere Verbrennungen hervorrufen. Batterien dieses Typs dürfen nicht aufgeladen, zerlegt, über 100°C erhitzt oder verbrannt werden. Auch darf ihr Inhalt nicht mit Wasser in Verbindung gebracht oder der zur richtigen Polung angebrachte Verbindungsstecker entfernt werden. Bei der Entsorgung die örtlichen Bestimmungen für Sondermüll beachten. Beim Ersetzen der Batterie nur Batterien des Typs verwenden, der in der Ersatzteilliste aufgeführt ist. Der Einsatz falscher Batterien kann zu Entzündung oder Explosion führen.



VORSICHT

Die Leuchtstoffröhre im LCD-Bildschirm enthält Quecksilber. Bei der Entsorgung die örtlichen Bestimmungen für Sondermüll beachten. Der LCD-Bildschirm besteht aus Glas und kann zerbrechen, wenn er unsachgemäß behandelt wird oder der Computer auf den Boden fällt. Wenn der Bildschirm beschädigt ist und die darin befindliche Flüssigkeit in Kontakt mit Haut und Augen gerät, sollten die betroffenen Stellen mindestens 15 Minuten mit Wasser abgespült und bei Beschwerden anschließend ein Arzt aufgesucht werden.



VORSICHT

Aus Sicherheitsgründen die Kunststoffabdeckung, die den unteren Teil der Spannungswandlerplatine umgibt, nicht entfernen.



VORSICHT

Obwohl Hauptbatterien eine niedrige Spannung haben, können sie doch bei Kurzschluß oder Erdung genug Strom abgeben, um brennbare Materialien zu entzünden oder Verletzungen bei Personen hervorzurufen.



VORSICHT

Wenn ein Austausch der FRU bei laufendem Betrieb nicht erlaubt ist, gehen Sie beim Austausch der FRU wie folgt vor: Schalten Sie den Computer aus, ziehen Sie alle Netzkabel von den Netzsteckdosen ab, entfernen Sie den Akku und ziehen Sie alle miteinander verbundenen Kabel ab.

Hebrew



סכנה

לפני הפעלת המחשב לאחר החלפת FRU יש לוודא שכל הברגים, הקפיצים, וחלקים קטנים אחרים נמצאים במקומם ואינם חופשיים לזוז בתוך המחשב. כדי לוודא זאת, יש לטלטל את המחשב ולהקשיב לגילוי קולות שקשוק. חלקי או שבבי מתכת עלולים לגרום לקצרים חשמליים.



סכנה

סוללות המתנה מסוימות מכילות כמות קטנה של ניקל וקדמיום. אין לפרק סוללת המתנה, לטעון אותה מחדש, להשליך אותה לאש או למים או לקצר אותה. יש לסלק את הסוללה כנדרש על ידי התקנות והחוקים המקומיים. יש להשתמש רק בסוללה המופיעה ברשימת החלקים המתאימה. שימוש בסוללה לא מתאימה עלול לגרום להצתה או התפוצצות של הסוללה.



סכנה

מארז הסוללה מכיל כמות קטנה של ניקל וקדמיום. אין לפרק את מארז הסוללה, להשליך אותו לאש או למים או לקצר אותו. יש לסלק את מארז הסוללה כנדרש על ידי התקנות והחוקים המקומיים. יש להשתמש רק בסוללה המופיעה ברשימת החלקים המתאימה בזמן החלפת מארז הסוללה. שימוש בסוללה לא מתאימה עלול לגרום להצתה או התפוצצות של הסוללה.



סכנה

סוללת הליתיום עלולה לגרום לשריפה, להתפוצצות או לכוויות קשות. אין לטעון אותה מחדש, לסלק את המחבר המקוטב שלה, לפרק אותה או לחמם אותה לטמפרטורה העולה על 100 מעלות צלזיוס. אין לשרוף את הסוללה ואין לחשוף את תוכן התא למים. יש לסלק את הסוללה כנדרש בתקנות ובחוקים המקומיים. יש להשתמש רק בסוללה המופיעה ברשימת החלקים המתאימים. שימוש בסוללה אחרת עלול לגרום לסכנת שריפה או התפוצצות.



סכנה

אם מסך הנביש חנוזלי (LCD) נשבר וחנוזל מתוך המסך בא במגע עם עיניכם או ידיכם, שטפו את האזורים הנגועים מיד במשך 15 דקות לפחות. פנו לקבלת עזרה רפואית אם תסמינים חנובעים מחמגע עם חנוזל נמשכים לאחר השטיפה.



סכנה

כדי למנוע התחשמלות, אין להסיר את מכסה הפלסטיק המגן על חלקו התחתון של הכרטיס ההפוך.



סכנה

אף שהסוללות הראשיות הן בעלות מתח נמוך, סוללה מקוצרת או מוארכת עלולה להפיק זרם מספיק לגרימת כוויות או להצתת חומרים דליקים.



סכנה

אלא אם כן מותרת יחלפה חמו' של ה-FRU המוחלק, פעלו כדלחלק לפני חסרתו :
כבו את המחשב, נתקו את כל כבלי החשמל מחשקעים, הוציאו את מארז הסוללות ונתקו את כל הכבלים
המחוברים.

Japanese



危険

FRUの交換後、ThinkPadの電源を入れる前に、ねじ、バネ、その他の小さな部品がすべて正しい位置にあり、またThinkPadの内部で緩んでいないことを確認してください。
これを確認するには、ThinkPadを振って、カチャカチャと音がしないか確かめます。金属部品や金属破片はショートの原因になることがあります。



危険

予備バッテリーの中には少量のニッケルとカドミウムが含まれているものがあります。したがって、予備バッテリーの分解、再充電、火または水の中への投棄、またはショートさせることは決して行わないでください。バッテリーを廃棄する場合は地方自治体の条例に従ってください。適切なパーツ・リストにあるバッテリーだけを使用してください。誤ったバッテリーを使用すると、バッテリーが発火したり、爆発したりすることがあります。



危険

バッテリー・バックには少量のニッケルが含まれています。バッテリー・バックを分解したり、火または水の中に投げ込んだり、ショートさせないでください。バッテリー・バックの廃棄にあたっては、地方自治体の条例または規則に従ってください。バッテリー・バックを交換するときは、適切なパーツ・リストにあるバッテリーだけを使用してください。誤ったバッテリーを使用すると、バッテリーが発火したり、爆発したりすることがあります。



危険

リチウム・バッテリーは、火災、爆発、または重症のやけどを引き起こすことがあります。バックアップ・バッテリーの充電、その極性コネクターの取り外し、バッテリー本体の分解、100°C (212°F) 以上への加熱、焼却、電池の中身を水に浸すことはしないでください。バッテリーを廃棄する場合は地方自治体の条例に従ってください。適切なパーツ・リストにあるバッテリーだけを使用してください。誤ったバッテリーを使用すると、バッテリーが発火したり、爆発したりすることがあります。



危険

LCDが破損し、LCDの中の液体が目に入ったり、手に触れたりした場合は、液体が触れた部分を少なくとも15分間洗い流してください。洗い流した後に、液体によって何らかの症状が現れた場合は、医師の治療を受けてください。



危険

感電を防ぐため、インバーター・カードの下部を保護しているプラスチック・カバーを外さないでください。



危険

メイン・バッテリーの電圧は低くても、ショートしたり、接地したバッテリーが、作業者にやけどを負わせたり、可燃物を燃やすだけの電流を発生させる場合があります。



危険

交換しようとしている FRU がホット・スワップに対応していない場合、それを取り外す前に、コンピューターの電源をオフにし、すべての電源コードをコンセントから抜き、バッテリー・パックを取り外して、相互接続しているケーブルをすべて切り離してください。

Korean



위험

FRU를 교체하고 나서 컴퓨터 전원을 켜기 전에 모든 나사, 스프링 및 기타 작은 부품들이 올바른 위치에 있는지, 컴퓨터 내부에 단단하게 연결되어 있는지 확인하십시오. 컴퓨터를 흔들어 달걀거리는 소리가 나지 않는지 확인하십시오. 금속 부품 또는 금속 조각은 누전을 일으킬 수 있습니다.



위험

일부 보조 배터리에는 소량의 니켈 및 카드뮴이 포함되어 있습니다. 보조 배터리를 분해하거나, 다시 충전하거나, 불 또는 물에 던지거나, 단락시키지 마십시오. 배터리 팩을 폐기할 때에는 해당 지역의 법률 규정을 따르십시오. 배터리 팩을 교체할 때에는 올바른 배터리만 사용하십시오. 올바르지 않은 배터리를 사용하면 배터리가 발화되거나 폭발할 수 있습니다.



위험

배터리 팩에는 소량의 니켈이 포함되어 있습니다. 배터리 팩을 분해하거나, 불 또는 물에 던지거나, 단락시키지 마십시오. 배터리 팩을 폐기할 때에는 해당 지역의 법률 규정을 따르십시오. 배터리 팩을 교체할 때에는 올바른 배터리만 사용하십시오. 올바르지 않은 배터리를 사용하면 배터리가 발화되거나 폭발할 수 있습니다.



위험

리튬 배터리는 화재, 폭발 또는 심각한 화상을 일으킬 수 있습니다. 리튬 배터리를 다시 충전하거나, 극성 커넥터를 제거하거나, 분해하거나, 100C(212F) 이상으로 가열하거나, 소각하거나, 전지 내용물을 물에 노출시키지 마십시오. 배터리를 폐기할 때에는 해당 지역을 법률 규정을 따르십시오. 올바른 배터리만 사용하십시오. 올바르지 않은 배터리를 사용하면 배터리가 발화되거나 폭발할 수 있습니다.



위험

LCD가 파손되어 LCD 내부의 액체가 눈에 들어가거나 손에 묻으면 즉시 깨끗한 물로 15분 이상 닦아 내십시오. 씻은 후에 조금이라도 이상을 느끼면 즉시 병원에 가서 의사의 진찰을 받아야 합니다.



위험

전기적 위험을 방지하려면 인버터 카드의 아래 부분을 보호하는 플라스틱 덮개를 제거하지 마십시오.



위험

기본 배터리의 전압은 낮지만, 단락되거나 접지된 배터리는 화상을 입히기에 충분한 전류와 가연성 물질을 발생시킬 수 있습니다.



위험

FRU 교체 시 Hot Swap이 지원되지 않는 경우, FRU를 제거하기 전에 컴퓨터의 전원을 끄고, 전기 콘센트에서 전원 코드를 분리하고, 배터리를 제거한 후, 연결된 모든 케이블을 분리하십시오.

Spanish



PELIGRO

Antes de encender el sistema despues de sustituir una FRU, compruebe que todos los tornillos, muelles y demás piezas pequeñas se encuentran en su sitio y no se encuentran sueltas dentro del sistema. Compruébelo agitando el sistema y escuchando los posibles ruidos que provocarían. Las piezas metálicas pueden causar cortocircuitos eléctricos.



PELIGRO

Algunas baterías de reserva contienen una pequeña cantidad de níquel y cadmio. No las desmonte, ni recargue, ni las eche al fuego o al agua ni las cortocircuite. Deséchelas tal como dispone la normativa local. Utilice sólo baterías que se encuentren en la lista de piezas. La utilización de una batería no apropiada puede provocar la ignición o explosión de la misma.



PELIGRO

Las baterías contienen pequeñas cantidades de níquel. No las desmonte, ni recargue, ni las eche al fuego o al agua ni las cortocircuite. Deséchelas tal como dispone la normativa local. Utilice sólo baterías que se encuentren en la lista de piezas al sustituir la batería. La utilización de una batería no apropiada puede provocar la ignición o explosión de la misma.



PELIGRO

La batería de repuesto es una batería de litio y puede provocar incendios, explosiones o quemaduras graves. No la recargue, ni quite el conector polarizado, ni la desmonte, ni caliente por encima de los 100°C (212°F), ni la incinere ni exponga el contenido de sus celdas al agua. Deséchela tal como dispone la normativa local.



PELIGRO

Si la LCD se rompe y el fluido de su interior entra en contacto con sus ojos o sus manos, lave inmediatamente las áreas afectadas con agua durante 15 minutos como mínimo. Obtenga atención médica si se presenta algún síntoma del fluido después de lavarse.



PELIGRO

Para evitar descargas, no quite la cubierta de plástico que rodea la parte baja de la tarjeta invertida.



PELIGRO

Aunque las baterías principales tienen un voltaje bajo, una batería cortocircuitada o con contacto a tierra puede producir la corriente suficiente como para quemar material combustible o provocar quemaduras en el personal.



PELIGRO

Salvo que se permita el intercambio en caliente para la unidad sustituible localmente, realice lo siguiente antes de extraerla: apague el sistema, desconecte todos los cables de alimentación de las tomas de alimentación eléctrica, extraiga la batería y desconecte los cables de interconexión.

Traditional Chinese



危險

完成 FRU 更換之後，在開啟電腦的電源之前，請確定所有螺絲、彈簧及其他小零件都已歸位，沒有遺留在電腦內部。
若要確認這一點，請搖晃電腦，聽聽看是否有卡嗒的聲響。
金屬零件或儀錶的火花會造成電線短路。



危險

部分備用電池含有微量的鎳和鎘。請勿拆開備用電池、再充電、丟入火或水中，或使其形成短路。請按照當地法令或規定來棄置電池。
僅限使用零件清單中的電池。使用不適當的電池會導致電池起火或爆炸。



危險

電池套件含有微量的鎳。請勿拆開電池套件、丟入火或水中，或使其形成短路。請按照當地法令或規定來棄置電池套件。

更換電池套件時，僅限使用零件清單中的電池。使用不適當的電池會導致電池起火或爆炸。



危險

鋰電池會導致起火、爆炸或嚴重燒傷。請勿再充電、拔除其電極接頭、拆開、加熱超過 **100°C (212°F)**、焚燒，或讓電池組成物浸到水。請按照當地法令或規定來棄置電池。

僅限使用零件清單中的電池。使用不適當的電池會導致電池起火或爆炸。



危險

如果 LCD 破裂導致 LCD 流出的液體沾到您的眼睛或手，請立即以清水沖洗沾染部位至少 15 分鐘。如果在清洗後出現該液體所造成的任何症狀，請就醫治療。



危險

為避免電擊，請勿拆下轉換卡下面的塑膠護蓋。



危險

雖然主電池的電壓很低，但短路或接地電池所產生的電流，仍足以使人燒傷或使可燃物質起火。



危險

除非 FRU 允許以熱抽換來替換，否則請依下列方式將其移除：將電腦關機，拔除插座上所有電源線，移除電池包，並拔開任何交互連接的線材。

Chapter 2. Diagnostics and troubleshooting

This chapter introduces several diagnostics applications to help you identify and solve the problems of your computer. If you still need help after running the applications, you can call Lenovo Customer Support Center.

Diagnostics applications

The following table lists diagnostics applications available on your computer, their running environments, and brief introductions to each application.

Table 1. Diagnostics applications

Diagnostics application	Running environment	Brief introduction
“Hardware scan in Vantage” on page 17*	Run in the operating system.	The Vantage application is preinstalled on the computer. Hardware scan in the Vantage application is an effective hardware testing tool to help you identify the hardware problems of your computer.
“UEFI diagnostics application” on page 18*	Run in the UEFI BIOS.	A UEFI diagnostics application is preinstalled on the computer. This application enables you to view system information and test some hardware components in your computer, especially when you cannot start up the operating system.
<ul style="list-style-type: none">• “Advanced diagnostics application (Windows version)” on page 18• “Advanced diagnostics application (bootable versions for Linux/UEFI)” on page 18	Run in the operating system or boot from USB (Need download).	Advanced diagnostics applications help you test a wider scope of hardware components in your computer that cannot be covered by hardware scan in the Vantage application or the UEFI diagnostics application.

* for selected models

Important: Be extremely careful during such writing operations as copying, saving, or formatting. Drives in the computer that you are servicing sequence might have been altered. If you select an incorrect drive, data or programs might be overwritten.

Hardware scan in Vantage

To run the hardware scan in Vantage, do the following:

- Step 1. Launch the Vantage app.
- Step 2. Click **Hardware scan** or **Support Services → Hardware scan**.
- Step 3. Choose one of the following ways to run the hardware scan:

Click **Refresh Modules** and check the list of hardware components currently available in the computer. Select **QUICK SCAN** to test all the hardware components detected.

Select **CUSTOMIZE** to choose one or several hardware components to be tested.

- Step 4. If any hardware failure is detected, the result varies depending on the warranty status and varies by country or region. Follow the on-screen instructions to resolve the issue.

UEFI diagnostics application

UEFI Diagnostics is consistently available as a boot option on Lenovo machines. To access the tool, follow these instructions:

- For ThinkPad, Thinkbook, and SMB systems, press the **F10** key during the boot process.
- For IdeaPad systems, access the **Novo button menu**, then select **Lenovo UEFI Diagnostics** from the menu. The application will start automatically.

The following table displays the items on the main screen of the UEFI diagnostics application. Depending on the model, the items might differ slightly.

Table 2. Items on the main screen of the UEFI diagnostics application

Category	Items
Tests	<ul style="list-style-type: none">• Storage• Memory• CPU• Display• Motherboard• Touch
Tools	<ul style="list-style-type: none">• System Information• Bad Block Recovery• Smart Information

Prepare a USB flash drive formatted in FAT32. After the test is executed, select **View Log → Save Log**. The test log is saved in the USB flash drive. You can view the log to find possible solutions or send the log to Lenovo for helps.

Advanced diagnostics application (Windows version)

To use the advanced diagnostics application (Windows version), do the following:

- Step 1. Go to <https://support.lenovo.com/solutions/ht506581>.
- Step 2. Select a Windows package that fits your scenario for download.
- Step 3. Double-click the downloaded file and complete the installation.
- Step 4. Launch the app and follow the on-screen instructions for diagnostics.

After the test is completed, select **Export Log** to save the diagnostic result. You can view the log to find possible solutions or send the log to Lenovo for helps.

Advanced diagnostics application (bootable versions for Linux/UEFI)

To use the advanced diagnostics application (bootable versions for Linux/UEFI), do the following:

- Step 1. Prepare a USB flash drive larger than 2 GB and make a backup of the content in the USB flash drive. (During the following diagnosing process, the content in the USB flash drive content will be erased.)

Note: During the following diagnostic process, the content on the USB flash drive will be erased.

- Step 2. Go to <https://support.lenovo.com/solutions/bootableusb>.
- Step 3. Follow the on-screen instructions to create a bootable USB and run the application from the bootable USB.

After the test is executed, select **View Log** → **Export Log**. The test log is saved in the USB flash drive. You can view the log to find possible solutions or send the log to Lenovo for helps.

Call Lenovo

If you have tried to correct the problem yourself and still need help, you can call Lenovo Customer Support Center.

Before you contact Lenovo

Record product information and problem details before you contact Lenovo.

Product information	Problem symptoms and details
<ul style="list-style-type: none">• Product name• Machine type and serial number	<ul style="list-style-type: none">• What is the problem? Is it continuous or intermittent?• Any error message or error code?• What operating system are you using? Which version?• Which software applications were running at the time of the problem?• Can the problem be reproduced? If so, how?

Note: The product name and serial number can usually be found on the bottom of the computer, either printed on a label or etched on the cover.

Lenovo Customer Support Center

During the warranty period, you can call Lenovo Customer Support Center for help.

Telephone numbers

For a list of the Lenovo Support phone numbers for your country or region, go to <https://pcsupport.lenovo.com/supportphonenumberlist>.

Note: Phone numbers are subject to change without notice. If the number for your country or region is not provided, contact your Lenovo reseller or Lenovo marketing representative.

Services available during the warranty period

- Problem determination - Trained personnel are available to assist you with determining if you have a hardware problem and deciding what action is necessary to fix the problem.
- Lenovo hardware repair - If the problem is determined to be caused by Lenovo hardware under warranty, trained service personnel are available to provide the applicable level of service.
- Engineering change management - Occasionally, there might be changes that are required after a product has been sold. Lenovo or your reseller, if authorized by Lenovo, will make selected Engineering Changes (ECs) that apply to your hardware available.

Services not covered

- Replacement or use of parts not manufactured for or by Lenovo or non-warranted parts
- Identification of software problem sources
- Configuration of UEFI/BIOS as part of an installation or upgrade
- Changes, modifications, or upgrades to device drivers
- Installation and maintenance of network operating systems (NOS)
- Installation and maintenance of programs

For the terms and conditions of the Lenovo Limited Warranty that apply to your Lenovo hardware product, see “Warranty information” in the *Safety and Warranty Guide* that comes with your computer.

Nonwarranted items and activities

During the warranty period, the customer may be responsible for repair costs if the computer damage was caused by misuse, accident, modification, unsuitable physical or operating environment, or improper maintenance by the customer. Following is a list of some common items that are not covered under warranty and some symptoms that might indicate that the system was subjected to stress beyond normal use.

Items not covered by warranty

- LCD panel cracked from the application of excessive force or from being dropped
- Scratched (cosmetic) parts
- Distortion, deformation, or discoloration of the cosmetic parts
- Plastic parts, latches, pins, or connectors that have been cracked or broken by excessive force
- Damage caused by liquid spilled into the system
- Damage caused by the improper insertion of a personal-computer card (PC card) or the installation of an incompatible card
- Improper disc insertion or use of an external optical drive
- Fuses blown by attachment of a non-supported device
- Forgotten computer password (making the computer unusable)
- Sticky keys caused by spilling a liquid onto the keyboard
- Use of an incorrect ac power adapter on laptop products

Symptoms that might indicate damage caused by non-warranted activities

- Missing parts might be a symptom of improper service or modification.
- Check for obvious damage to a hard disk drive. If the spindle of a hard disk drive becomes noisy, the hard disk drive might have been dropped or subject to excessive force.

Chapter 3. Parts, screws, and tools

Parts

Before proceeding with part replacement, get to know part type definition, learn to look up a part on the Lenovo Support Web site, and gain an overview of all CRUs/FRUs in this computer through the exploded view.

Part type definition

Your computer contains the following types of “Customer Replaceable Unit” (CRU)s and “Field Replaceable Unit” (FRU)s:

- **Self-service CRUs:** Refer to parts that can be replaced easily by customer themselves or by trained service technicians at an additional cost.
- **Optional-service CRUs:** Refer to parts that can be replaced by customers with a greater skill level. Trained service technicians can also provide service to replace the parts under the type of warranty designated for the customer’s product.
- **FRUs:** Refer to parts that are more complicated to replace and it is recommended that these parts should be replaced by trained service technicians. If customers elect to replace the FRU by themselves, we recommend that you ensure the correct instructions are carefully followed.

Important notes:

- **CRU statement for customers:**
 - You can resolve some problems with your product by replacing a CRU. For self-service CRUs, installation is your responsibility. For optional-service CRUs, you can either install the CRU yourself or you can request that a Service Provider install the CRU according to the warranty service for your product.
 - If you intend on installing the CRU, Lenovo will ship the CRU to you. CRU information and replacement instructions are shipped with your product and are available from Lenovo at any time upon request.
 - You can find a list of CRUs for your product in this *Hardware Maintenance Manual*. To find this manual, go to <https://support.lenovo.com> and search by product.
- **CRU/FRU statement:**
 - **Replace a CRU/FRU only with another CRU/FRU of the correct model.** When you replace a CRU/FRU, make sure that the model of the machine and the CRU/FRU part number are correct.
 - **A CRU/FRU should not be replaced because of a single unreproducible failure.** Single failures can occur for a variety of reasons that have nothing to do with a hardware defect, such as cosmic radiation, electrostatic discharge, or software errors. Consider replacing a CRU/FRU only when a problem recurs. If you suspect that a CRU/FRU is defective, clear the error log and run the test again. If the error does not recur, do not replace the CRU/FRU.
 - **Be careful not to replace a nondefective CRU/FRU.**
 - When you return a CRU/FRU, you must include the following information in the parts exchange form or parts return form that you attach to it:
 1. Name and phone number of service technician
 2. Date of service
 3. Date on which the machine failed
 4. Date of purchase
 5. Failure symptoms, error codes appearing on the display, and beep symptoms

6. Procedure index and page number in which the failing CRU/FRU was detected
7. Failing CRU/FRU name and part number
8. Machine type, model number, and serial number
9. Customer's name and address

Look up a part

1. For more detailed CRU/FRU information, including part numbers, descriptions, and substitution part numbers, go to <https://support.lenovo.com/partslookup>.
2. Type the product name, the machine type or the serial number in the corresponding field to get a general CRU/FRU list.

Exploded view and part list

By the exploded view and the part list, you can find the images, names, and types of all the CRU/FRUs of your computer.

System Exploded view (14-inch models)

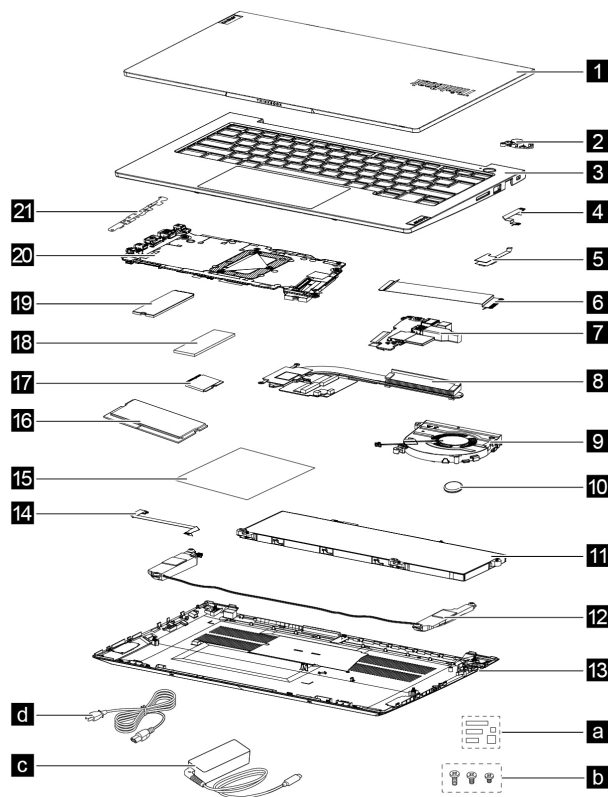

Part list

Self-service CRUs:

- c** ac power adapter*
- d** Power cord*

Optional-service CRU:

- 13** “Lower Case” on page 32
- 16** “Memory module” on page 40
- 19** “M.2 solid-state drive” on page 49

FRUs:

- 1** “LCD module” on page 66
- 2** “Power button*” on page 63
- 3** “Upper case (with keyboard)” on page 70
- 4** “Fingerprint sensor cable*” on page 64
- 5** “Fingerprint sensor board*” on page 64
- 6** “I/O board cable” on page 55
- 7** “I/O board” on page 59
- 8** “Heat sink” on page 41
- 9** “Fan” on page 46
- 10** “CMOS battery” on page 51
- 11** “Battery pack” on page 35
- 12** “Speakers” on page 52
- 14** “Touchpad board cable” on page 38
- 15** “AL foil mylar” on page 41
- 17** “Wi-Fi card” on page 50
- 18** “M.2 solid-state drive thermal pad” on page 49
- 20** “System board” on page 55
- 21** “I/O bracket” on page 53
- a** Label pack
- b** Screw kit

System Exploded view (16-inch models)

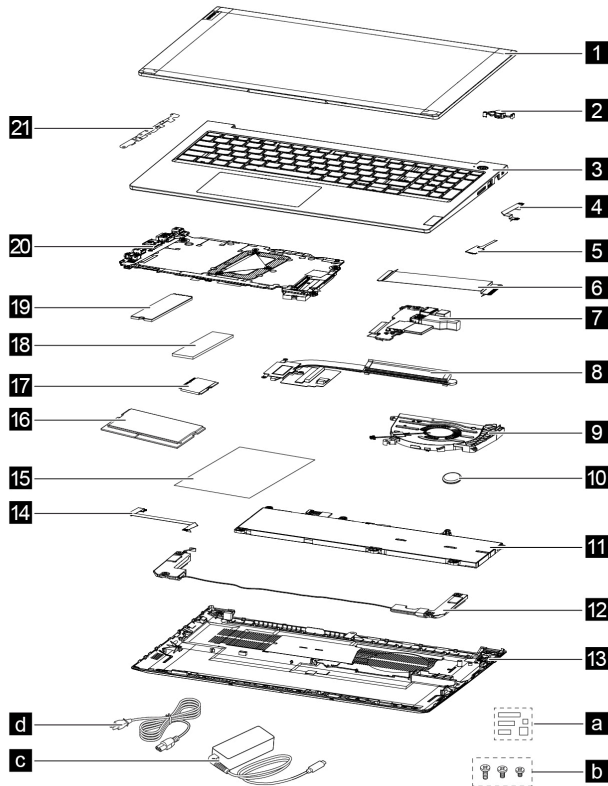

Part list

Self-service CRUs:

c ac power adapter*

d Power cord*

Optional-service CRU:

13 “Lower case” on page 32

16 “Memory module” on page 40

19 “M.2 solid-state drive” on page 49

FRUs:

1 “LCD module” on page 68

2 “Power button” on page 64

3 “Upper case (with keyboard)” on page 70

4 “Fingerprint sensor cable” on page 65

5 “Fingerprint sensor board” on page 65

6 “I/O board cable” on page 56

7 “I/O board” on page 61

8 “Heat sink” on page 43

9 “Fan” on page 47

10 “CMOS battery” on page 51

11 “Battery pack” on page 35

12 “Speakers” on page 52

14 “Touchpad board cable” on page 39

15 “AL foil mylar” on page 43

17 “Wi-Fi card” on page 50

18 “M.2 solid-state drive thermal pad” on page 49

20 “System board” on page 56

21 “I/O bracket” on page 53

a Label pack

b Screw kit

LCD Module Exploded view (14-inch models)

Part list

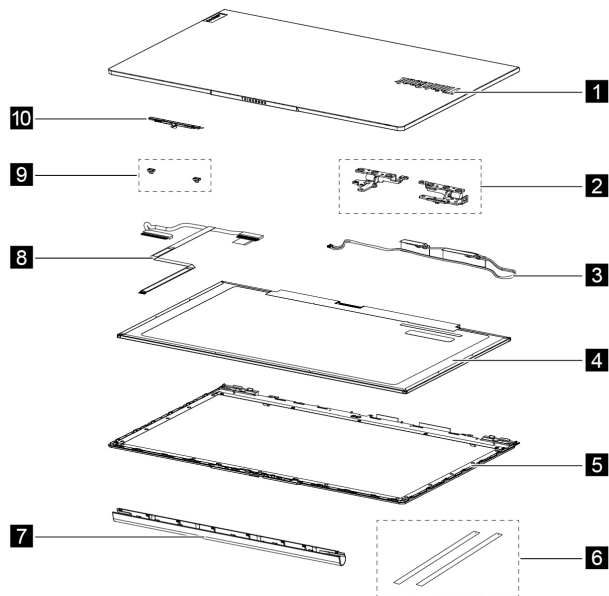

FRUs:

- 1 "LCD cover" on page 78
- 2 "Hinges" on page 72
- 3 "Antennas" on page 75
- 4 "LCD panel" on page 74
- 5 "LCD bezel" on page 71
- 6 "Removable tapes" on page 71
- 7 "Hinge cover" on page 70
- 8 "EDP cable" on page 77
- 9 "Mic rubbers" on page 73
- 10 "Camera board" on page 76

LCD Module Exploded view (16-inch models)

Part list

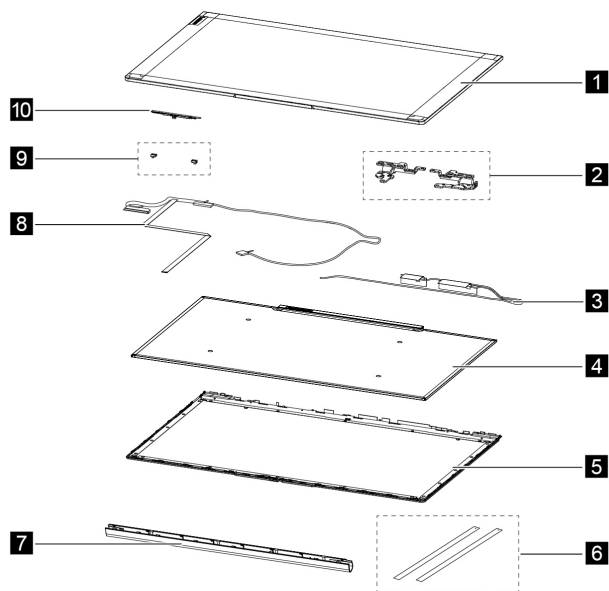

FRUs:

- 1 "LCD cover" on page 78
- 2 "Hinges" on page 72
- 3 "Antennas" on page 75
- 4 "LCD panel" on page 74
- 5 "LCD bezel" on page 71
- 6 "Removable tapes" on page 71
- 7 "Hinge cover" on page 70
- 8 "EDP cable" on page 77
- 9 "Mic rubbers" on page 73
- 10 "Camera board" on page 76

* for selected models

Screws

This section provides the screw list of this computer and the screw notices you need to know before hardware replacement.

Screw list

The following table includes screw specifications, torque information, and screw colors of this product.

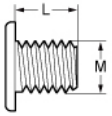

The number after the letter L refers to the length of the screw shank measured from under the head to the tip of the screw. The number after the letter M refers to the width of the screw shank measured across the outermost points in a metric screw.

Table 3. Screw list of this product

Thread (mm)	Length (mm)	Torque (kgf.cm)	Color
M2	L2	1.85 ± 0.15	Black
M2	L2	1.85 ± 0.15	Silver
M2	L3	1.85 ± 0.15	White
M2	L4	1.85 ± 0.15	Black
M2	L4	<ul style="list-style-type: none"> For plastic lower case: 1.5 ± 0.15 For metal lower case: 1.85 ± 0.15 	Silver
M2	L8	<ul style="list-style-type: none"> For plastic lower case: 1.5 ± 0.15 For metal lower case: 1.85 ± 0.15 	Silver
M2.5	L6	3.0 ± 0.3	Black
M2.5	L7	3.0 ± 0.3	Black

You can refer to the following table to choose a properly matched screwdriver.

Notes:

-  The Phillips head screw has a cross-shaped slot in the screw head.

Table 4. Choose a properly matched screwdriver

Screw head type	Thread (mm)	Screwdriver type
Phillips head	< M1.2	PH00
Phillips head	M1.6 – M2	PH0 or PH1
Phillips head	> M2	PH1
Torx head	M2	T5

Screw notices

Do the following when you service the computer:

- Carefully retain and reuse all screws.
- Keep the screw kit in your tool bag. For the part number of the screw kit, go to: <https://support.lenovo.com/partslookup>.

- Use the correct screw as shown in the CRU/FRU replacement procedures.
- Turn the screws in the direction as given by the arrow in the CRU/FRU replacement illustration.
- If you have a torque screwdriver, tighten all screws firmly to the torque specified in the screw information table for each step.
- Ensure torque screwdrivers are calibrated correctly following country specifications.

Loose screws can cause a reliability problem. In your computer, this problem is addressed with special nylon-coated screws that have the following characteristics:

- They maintain tight connections.
- They do not easily come loose, even with shock or vibration.
- They are harder to tighten.

Tighten screws as follows:

- **Plastic to plastic**

Turn an additional angle of 90 degrees after the screw head touches the surface of the plastic part.

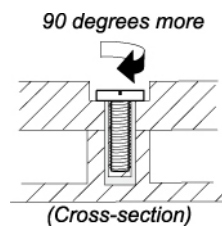

- **Logic card to plastic**

Turn an additional angle of 180 degrees after the screw head touches the surface of the logic card.

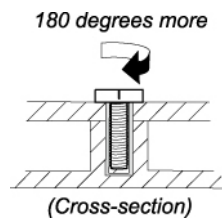

Service tools

The following table lists all tools for servicing Lenovo products. Tools required to service a part are listed in the specific part disassembly topic. Prepare them before you service the product.

Table 5. Service tools









No.	Reference image	Tool name	Specification	Tool type
1		Screwdriver set	<ul style="list-style-type: none"> • PH0, PH00, PH1, PH2 • T5, T15, T20, T30 <p>Note: Use a screwdriver with the shank length greater than 6 inches for Desktop, Workstation, and Smart device product.</p>	Common tool
2		Pry tool	N/A	Common tool
3		Tweezers	<ul style="list-style-type: none"> • Conductive • Isolated 	Common tool
4		Suction cup	N/A	Common tool
5		Hexagonal socket	<ul style="list-style-type: none"> • For VGA: H5 mm or H4.8 mm • For Tiny antenna: H8 mm 	Common tool
6		Adjustable torque screwdriver	0.2 Nm to 4.0 Nm, Threadripper CPU, CAMM, etc	Common tool
7		ESD mat	N/A	Common tool
8		USB flash drive	For Golden Key, Chrome Reloads, AutoPilot, etc	Common tool

Table 5. Service tools (continued)



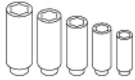











No.	Reference image	Tool name	Specification	Tool type
9		USB-C to USB-A converter	N/A	Common tool
10		Thermal pad	Variety of thickness, most common 0.5mm thickness pad under the component	Consumable tool
11		Thermal interface materials	N/A	Consumable tool
12		Acetate tape	N/A	Consumable tool
13		Polyimide tape	N/A	Consumable tool
14		Mylar tape	N/A	Consumable tool
15		Electrical tape	N/A	Consumable tool
16		Double-sided tape	N/A	Consumable tool
17		Conductive tape	N/A	Consumable tool

Table 5. Service tools (continued)

No.	Reference image	Tool name	Specification	Tool type
18		Eraser	N/A	Consumable tool
19		Cleaning wipes	N/A	Consumable tool
20		Touchpad jig (this might come with touchpad)	N/A	Consumable tool
21		Heat gun	N/A	Special tool
22		Brown brush	25 mm to 35 mm wide	Special tool
23		Contact cleaner spray	WD-40 Contact cleaner for battery connector	Special tool
24		Hexagonal socket	H17 mm	Special tool

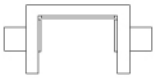
Chapter 4. Hardware replacement

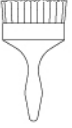
This chapter provides instructions on how to remove and install the hardware components of your computer.

General guidelines



Before removing any FRU or CRU, shut down the computer, unplug all power cords from electrical outlets, and wait about ten minutes to let the computer cool down.

When removing or replacing a CRU/FRU, ensure that you observe the following general guidelines:

1. Before replacing any CRU/FRU, ensure that you have read [Generic Safety and Compliance Notices](#).
2. Begin by removing any CRUs/FRUs that have to be removed before replacing the failing CRU/FRU. Any such CRUs/FRUs are listed at the beginning of each CRU/FRU replacement procedure. Remove them in the order in which they are listed.
3. Follow the correct sequence in the steps for removing a CRU/FRU, as shown in the illustrations by the numbers in square callouts.
4. When removing a CRU/FRU, move it in the direction as shown by the arrow in the illustration.

Attention:

- After replacing a CRU/FRU, do not turn on the computer until you have ensured that all screws, springs, and other small parts are in place and none are loose inside the computer. Verify this by shaking the computer gently and listening for rattling sounds. Metallic parts or metal flakes can cause electrical short circuits.
- The system board is sensitive to and can be damaged by ESD. Before touching it, establish personal grounding by touching a ground point with one hand or by using an ESD strap (P/N 6405959).

Connectors and cables for replacement

This topic provides information to help Lenovo-authorized service technicians identify connectors and cables for replacement purpose. To view each CRU/FRU and the exploded illustration of the computer, see “Exploded view and part list” on page 22.

Note: Depending on your computer model, some connectors or cables might not be available.

System board connectors and cables

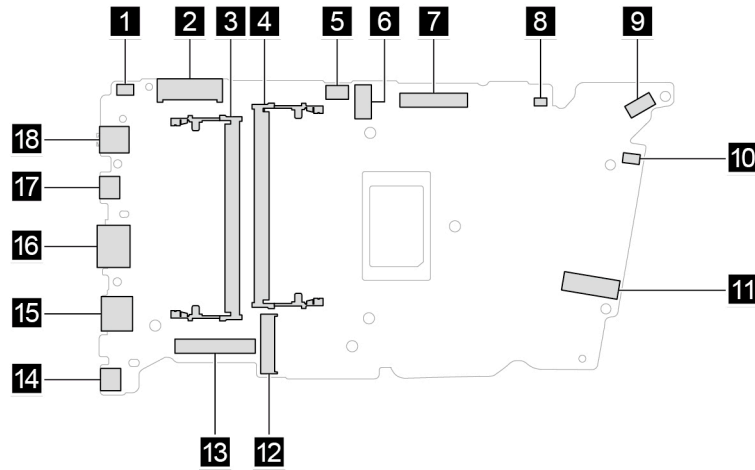

Table 6. System board connectors and cables for replacement

No.	Connector/feature	Internal cable required	Cable connection
1	Speaker connector (internal)	Speaker assembly cable	Connect the speaker assembly cable to this connector.
2	Second M.2 solid-state drive slot (internal)	No	Insert the second M.2 solid-state drive directly to the slot.
3 4	Memory slots	No	Insert the memory directly to the slot.
5	Haptic Touchpad connector (internal)	Haptic Touchpad cable	Connect one end of the Haptic Touchpad cable to the Haptic Touchpad and the other end to this connector.
6	Built-in battery connector (internal)	Built-in battery cable	Connect the built-in battery cable to this connector.
7	Keyboard assembly connector	Keyboard assembly cable	Connect the keyboard assembly cable to this connector.
8	Keyboard backlit connector	Keyboard backlit cable	Connect the keyboard backlit cable to this connector.
9	Touch screen connector	Touch screen cable	Connect the internal touch screen.
10	Fan assembly connector (internal)	Fan assembly cable	Connect the fan assembly cable to this connector.
11	M.2 solid-state drive slot (internal)	No	Insert M.2 solid-state drive directly to the slot.
12	M.2 Wi-Fi card slot (internal)	No	Insert M.2 Wi-Fi card directly to the slot.
13	Display assembly connector	Display cable	Connect the display cable to this connector.

Table 6. System board connectors and cables for replacement (continued)

No.	Connector/feature	Internal cable required	Cable connection
14	<ul style="list-style-type: none"> • USB-C (USB4) connector (external) (for ThinkBook 14 G9 AHP and ThinkBook 16 G9 AHP) • USB-C connector (external) (for ThinkBook 14 G9 IRL and ThinkBook 16 G9 IRL) • USB-C (Thunderbolt 4) connector (external) (ThinkBook 14 G9 IPL and ThinkBook 16 G9 IPL) 	No	Connect a USB-C compatible, USB4 or Thunderbolt 4 compatible device to this connector.
15	USB-A connector	No	Connect a USB-A compatible device to this connector.
16	HDMI connector (external)	No	Connect a compatible digital audio device or video monitor to this connector.
17	<ul style="list-style-type: none"> • USB-C (USB4) connector (external) (for ThinkBook 14 G9 AHP and ThinkBook 16 G9 AHP) • USB-C (Thunderbolt 4) connector (external) (ThinkBook 14 G9 IPL, ThinkBook 14 G9 IRL, ThinkBook 16 G9 IPL, and ThinkBook 16 G9 IRL) 	No	Connect a USB-C compatible, USB4 or Thunderbolt 4 compatible device to this connector.
18	Audio connector (external)	No	Connect headphones or a headset to this connector.

Lower case

Before you start, ensure that you have read Chapter 1 “Safety requirements for hardware maintenance” on page 1 and “General guidelines” on page 30.

Step 1. Place the computer upside down on a flat surface.

Step 2. Remove nine screws. Then, pry up the latches and remove the lower case.

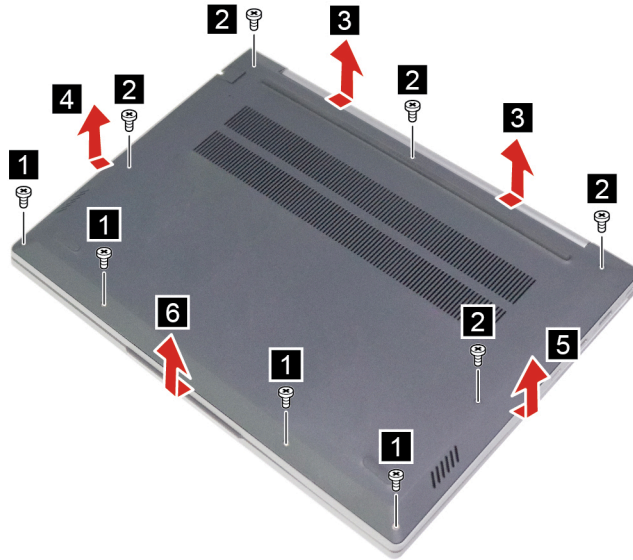

Figure 1. Remove nine screws and the lower case

Table 7. Screws used to secure the lower case

Label	Thread	Length (mm)	Torque (kgf.cm)	Quantity
1	M2	4	<ul style="list-style-type: none"> For plastic lower case: 1.5 ± 0.15 	4
2	M2	8	<ul style="list-style-type: none"> For metal lower case: 1.85 ± 0.15 	5

Step 3. Install the lower case in reverse order.

Label locations

When replacing the base cover, reapply all labels that come with the replacement base cover. If some original labels are not included with the replacement base cover, peel them off from the original base cover and paste them on the replacement base cover.

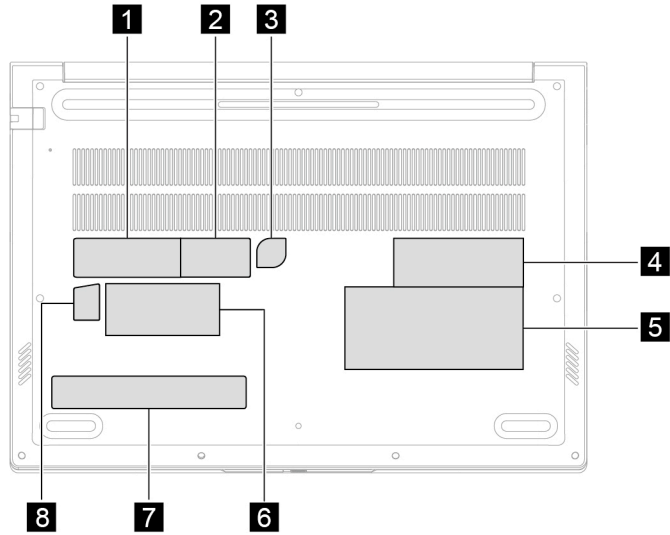

Figure 2. Label layout on the back side of the base cover

Labels attached to the base cover are country/region specific. Make sure to apply the appropriate labels to the replacement base cover.

Table 8. All base cover labels

Label	Label description	Applied country/region	Label dimensions
1	Rating label	All	100 mm x 30 mm
2	QR Code Label	All	17 mm x 26.1 mm
3	RFID label*	All	80 mm x 30 mm
4	Asset tag label	All	50.8 mm x 25.4 mm
5	Asset tag label	All	110 mm x 51 mm

Table 8. All base cover labels (continued)

Label	Label description	Applied country/region	Label dimensions
6	Country/region label and CO2 offset label	Argentina (W/L)	32 mm x 10 mm
			68 mm x 6 mm
		TW	70 mm x 10 mm
		Malaysia	8 mm x 8 mm
		Japan	32 mm x 10 mm
		Korea	43 mm x 24 mm
		Brazil	16.5 mm x 15 mm
		US/CA	32 mm x 10 mm
		South Africa	20 mm x 10 mm
		China	30 mm x 30 mm
			16 mm x 21 mm
		Vietnam	10 mm x 9 mm
		Belarus	40 mm x 8 mm
		India (BIS)	22 mm x 30 mm
7	Battery warning label	US	120 mm x 20 mm

* for selected models

Battery pack

- Before you start, ensure that you have read Chapter 1 “Safety requirements for hardware maintenance” on page 1 and “General guidelines” on page 30.
- Make sure the following FRUs (or CRUs) have been removed.
 - “Lower case” on page 32

Step 1. Lift the corner of the AL foil mylar.

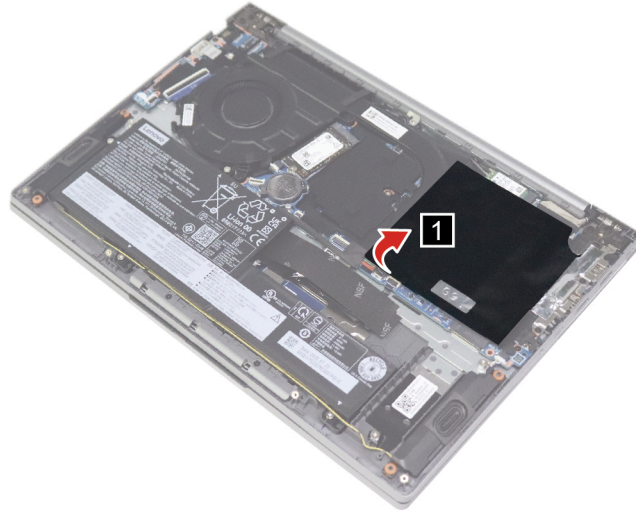

Figure 3. Lift the corner of the AL foil mylar

Step 2. Disconnect the battery pack cable from the system board and release the speakers' cable from the cable guide.

Attention: Use your fingernail to pull the connector to unplug it. Do not pull the cable.

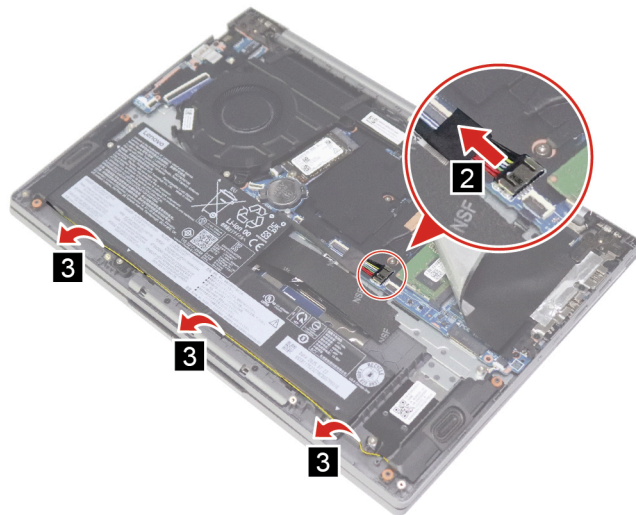

Figure 4. Disconnect the battery pack cable and release the speakers' cable

Step 3. Loosen four screws and remove the battery pack.

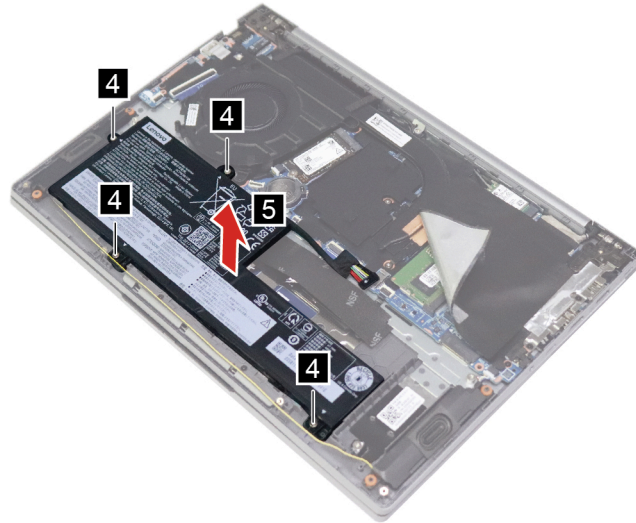

Figure 5. Loosen four screws and remove the battery pack

Note: For models with a 3-cell battery, refer to the removal steps in the figure above. Whereas for models with a 4-cell battery, refer to the removal steps to remove five screws and the battery pack as shown in the figure below.

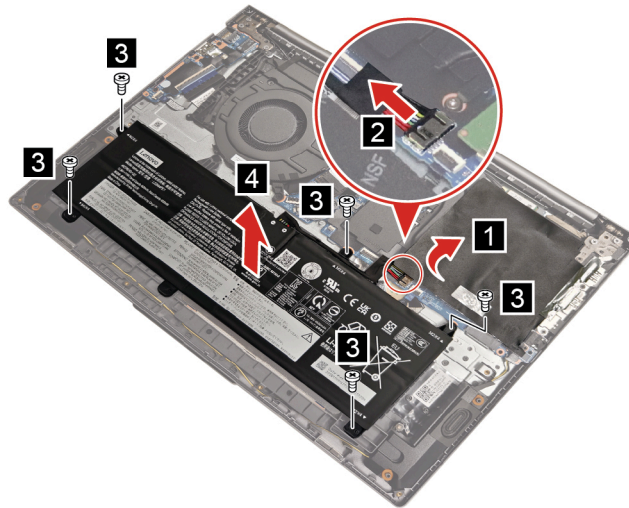

Figure 6. Remove five screws and the battery pack

Table 9. Screws used to secure the battery pack

Thread	Length (mm)	Torque (kgf.cm)	Quantity
M2	4	1.85 ± 0.15	5

Step 4. Install the battery pack in reverse order.

Touchpad board cable

Touchpad board cable (14-inch models)

- Before you start, ensure that you have read Chapter 1 “Safety requirements for hardware maintenance” on page 1 and “General guidelines” on page 30.
- Make sure the following FRUs (or CRUs) have been removed.
 - “Lower case” on page 32
 - “Battery pack” on page 35

Step 1. Remove the battery sponge.

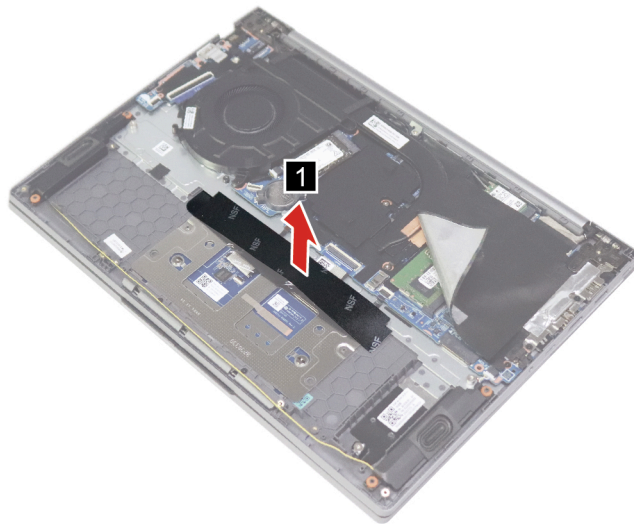

Figure 7. Remove the battery sponge

Step 2. Lift the keyboard cable.



Figure 8. Lift the keyboard cable

Step 3. Disconnect the touchpad board cable from both the system board and the touchpad, then remove the touchpad board cable.

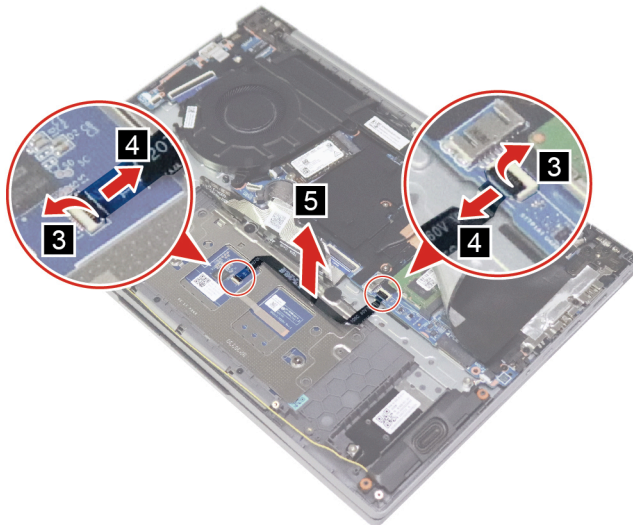

Figure 9. Disconnect and remove the touchpad board cable

Step 4. Install the touchpad board cable in reverse order.

Touchpad board cable (16-inch models)

- Before you start, ensure that you have read Chapter 1 “Safety requirements for hardware maintenance” on page 1 and “General guidelines” on page 30.
- Make sure the following FRUs (or CRUs) have been removed.
 - “Lower case” on page 32

“Battery pack” on page 35

Step 1. Disconnect the touchpad board cable from both the system board and the touchpad, then remove the touchpad board cable.

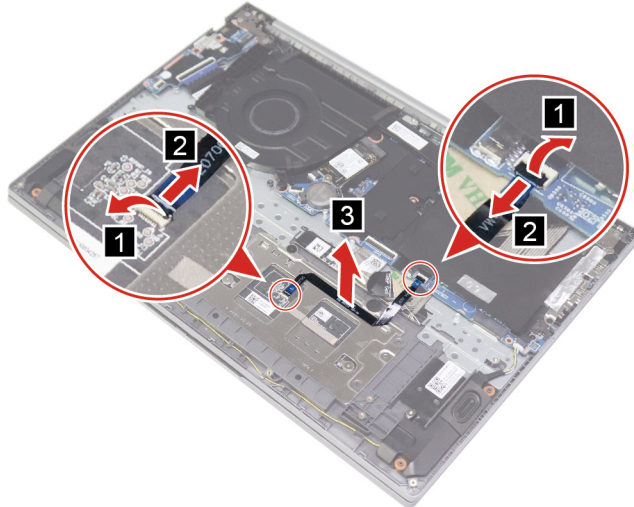

Figure 10. Disconnect and remove the touchpad board cable

Step 2. Install the touchpad board cable in reverse order.

Memory module

- Before you start, ensure that you have read Chapter 1 “Safety requirements for hardware maintenance” on page 1 and “General guidelines” on page 30.
- Make sure the following FRUs (or CRUs) have been removed.
 - “Lower case” on page 32

Step 1. Remove the AL foil mylar and disconnect the battery pack cable from the system board.

Attention: Use your fingernail to pull the connector to unplug it. Do not pull the cable.

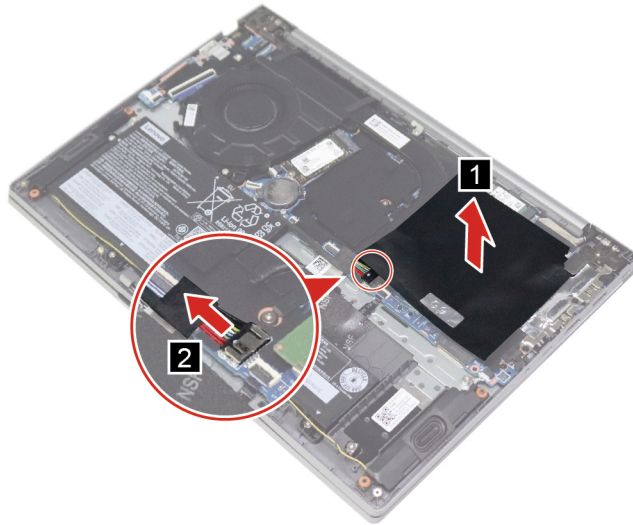

Figure 11. Remove the AL foil mylar and disconnect the battery pack cable

Step 2. Open the latches and remove the memory module.

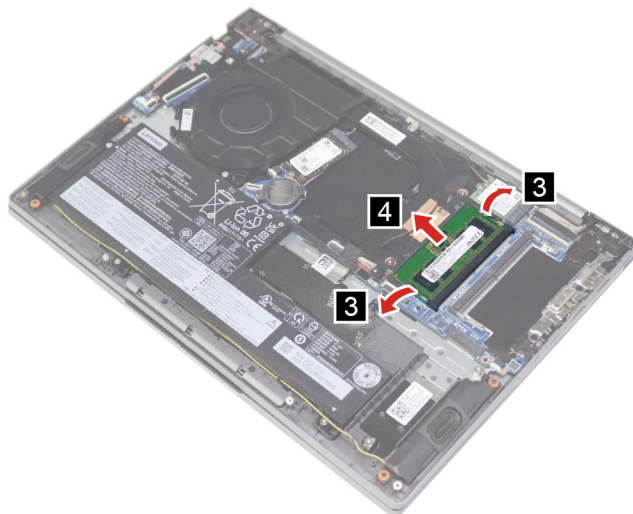

Figure 12. Remove the memory module

Step 3. Install the memory module in reverse order.

Heat sink

Heat sink (14-inch models)

- Before you start, ensure that you have read Chapter 1 “Safety requirements for hardware maintenance” on page 1 and “General guidelines” on page 30.
- Make sure the following FRUs (or CRUs) have been removed.

“Lower case” on page 32

Step 1. Remove the AL foil mylar and disconnect the battery pack cable from the system board.

Attention: Use your fingernail to pull the connector to unplug it. Do not pull the cable.

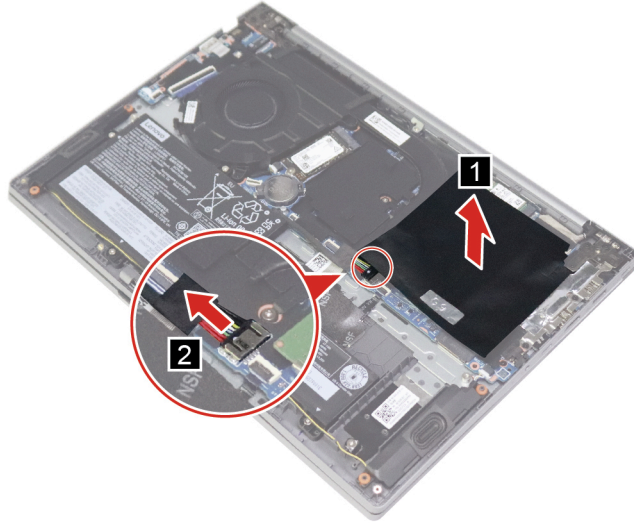

Figure 13. Remove the AL foil mylar and disconnect the battery pack cable

Step 2. Remove three screws in the alphabetical order and remove the heat sink.

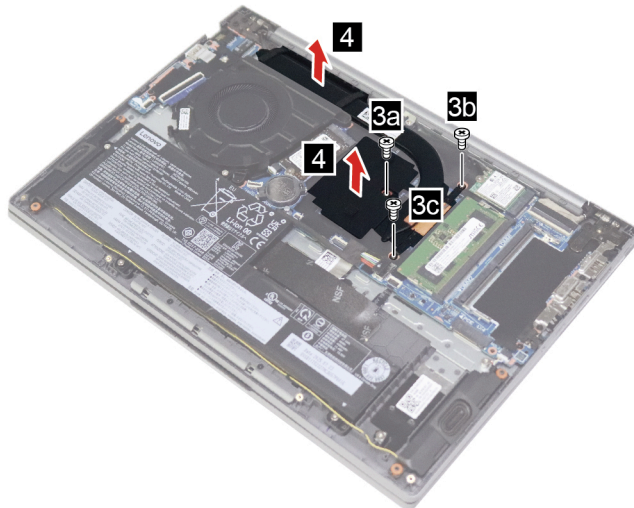

Figure 14. Remove three screws and the heat sink

Table 10. Screws used to secure the heat sink

Thread	Length (mm)	Torque (kgf.cm)	Quantity
M2	3	1.85 ± 0.15	3

Step 3. Install the heat sink in reverse order.

Heat sink (16-inch models)

- Before you start, ensure that you have read Chapter 1 “Safety requirements for hardware maintenance” on page 1 and “General guidelines” on page 30.
- Make sure the following FRUs (or CRUs) have been removed.
 - “Lower case” on page 32

Step 1. Remove the AL foil mylar and disconnect the battery pack cable from the system board.

Attention: Use your fingernail to pull the connector to unplug it. Do not pull the cable.

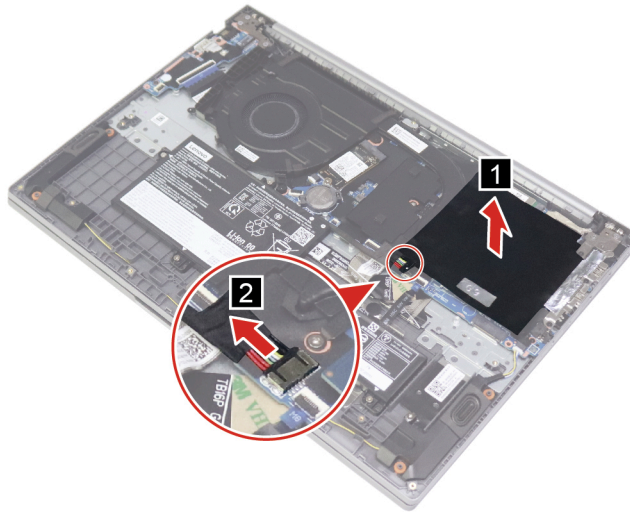

Figure 15. Remove the AL foil mylar and disconnect the battery pack cable

Step 2. Remove three screws in the alphabetical order and remove the heat sink bracket.

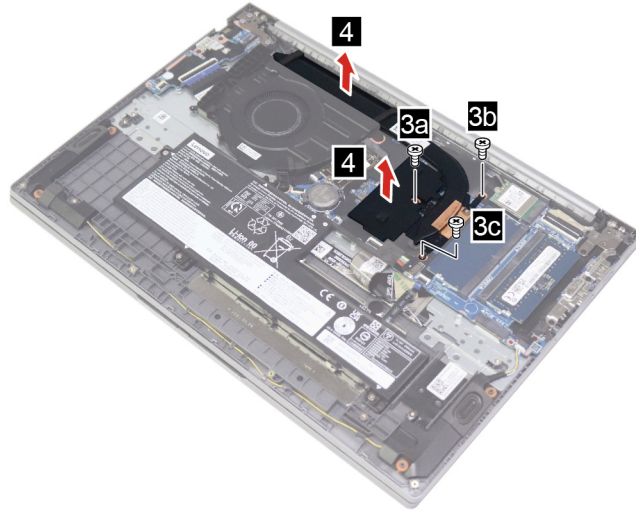

Figure 16. Remove three screws and remove the heat sink bracket

Table 11. Screws used to secure the heat sink bracket

Thread	Length (mm)	Torque (kgf.cm)	Quantity
M2	3	1.85 ± 0.15	3

Step 3. Remove two screws and remove the heat sink.

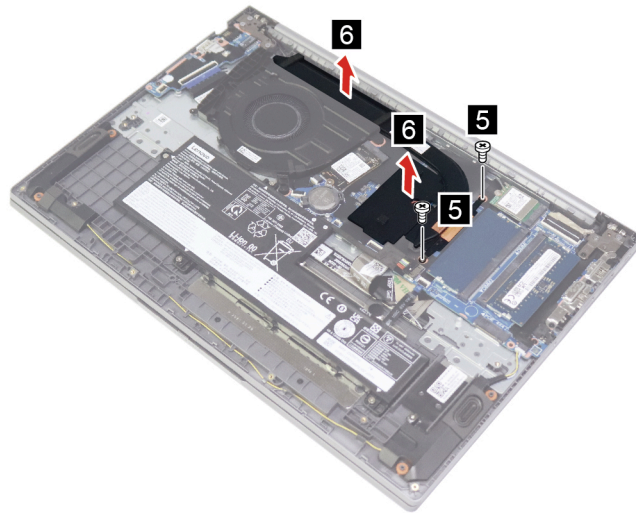

Figure 17. Remove two screws and the heat sink

Table 12. Screws used to secure the heat sink

Thread	Length (mm)	Torque (kgf.cm)	Quantity
M2	3	1.85 ± 0.15	2

Step 4. Install the heat sink in reverse order.

Handling thermal interface materials

Thermal interface materials are typically applied between a heat sink and a CPU (and/or GPU) die to enhance the heat transfer capability of the heat sink. If thermal interface materials are exposed during computer servicing, such as when replacing the heat sink or system board, it is important to handle the thermal interface materials properly.

- You need to completely remove the old thermal interface materials from the CPU and/or GPU die.
- You need to apply new thermal interface materials onto the heat sink according to the type, quantity, and application areas specified in this publication.

Related topics

“Heat sink” on page 41

“System board” on page 55

Type, quantity, and area of thermal interface materials application on the heat sink

The table and figure below provide information on the type and quantity of thermal interface materials, as well as the specific area on the heat sink where these materials should be applied.

Area	Type	Quantity
a	X-23-8160	0.18 g, 17 mm × 12 mm × 0.2 mm (for AMD models)
		0.29 g, 30.34 mm × 11.24 mm × 0.2 mm (for Intel models)
		0.21 g, 16.82 mm × 14.43 mm × 0.2 mm

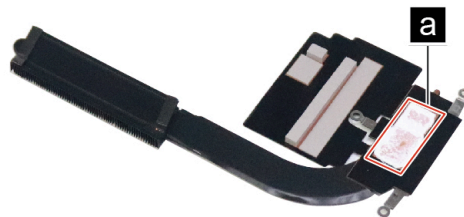

Figure 18. Area on the heat sink where thermal interface materials should be applied

Area on the system board where thermal interface materials are applied

The following figure shows the area on the system board where thermal interface materials are applied.



Figure 19. Area on the system board where thermal interface materials are applied

Fan

Fan (14-inch models)

- Before you start, ensure that you have read Chapter 1 “Safety requirements for hardware maintenance” on page 1 and “General guidelines” on page 30.
- Make sure the following FRUs (or CRUs) have been removed.
 - “Lower case” on page 32

Step 1. Lift the corner of the AL foil mylar and disconnect the battery pack cable from the system board. Then, disconnect the fan cable from the system board, remove three screws, and remove the fan.

Attention: Use your fingernail to pull the connector to unplug it. Do not pull the cable.

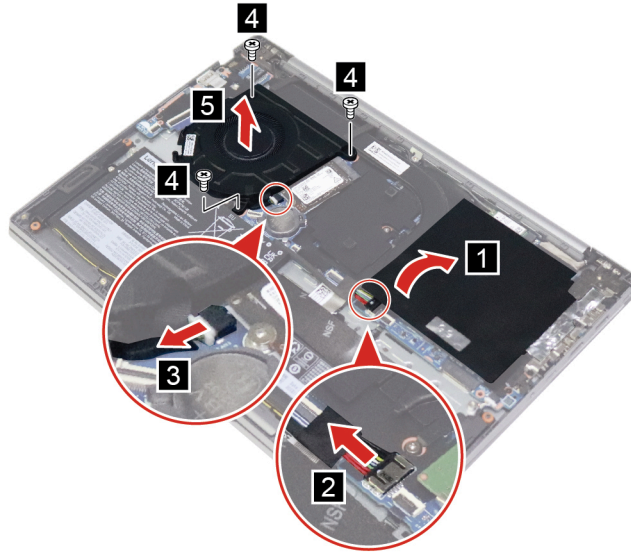

Figure 20. Remove the fan

Table 13. Screws used to secure the fan

Thread	Length (mm)	Torque (kgf.cm)	Quantity
M2	4	1.85 ± 0.15	3

Step 2. Install the fan in reverse order.

Fan (16-inch models)

- Before you start, ensure that you have read Chapter 1 “Safety requirements for hardware maintenance” on page 1 and “General guidelines” on page 30.
- Make sure the following FRUs (or CRUs) have been removed.

“Lower case” on page 32

Step 1. Lift the corner of the AL foil mylar and disconnect the battery pack cable from the system board.

Attention: Use your fingernail to pull the connector to unplug it. Do not pull the cable.

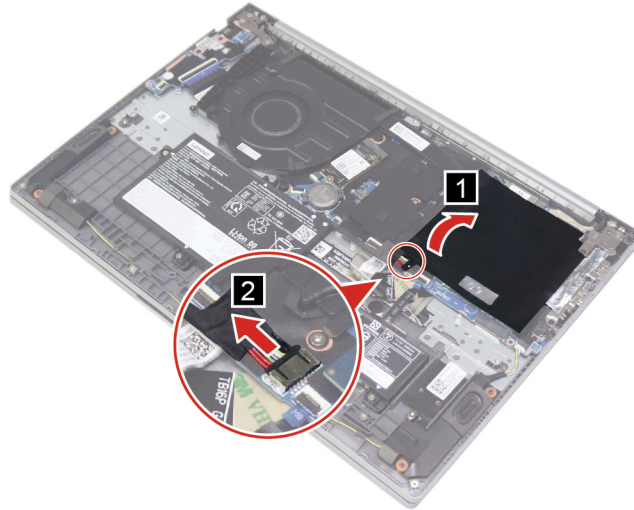

Figure 21. Lift the corner of the AL foil mylar and disconnect the battery pack cable

Step 2. Disconnect the fan cable from the system board, remove three screws, and remove the fan.

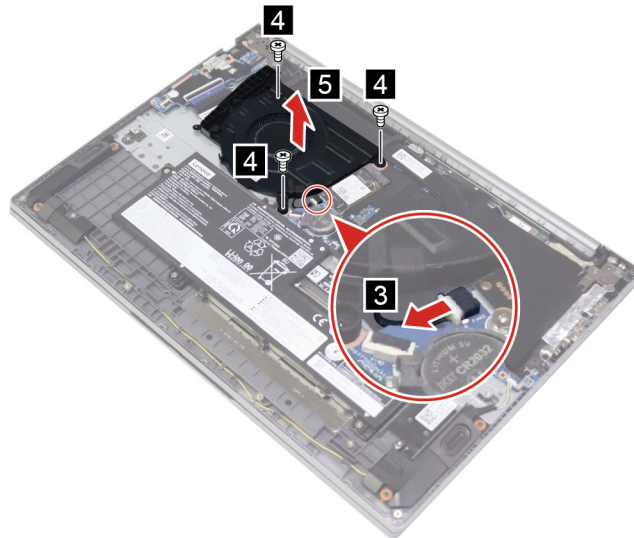

Figure 22. Remove the fan

Table 14. Screws used to secure the fan

Thread	Length (mm)	Torque (kgf.cm)	Quantity
M2	4	1.85 ± 0.15	3

Step 3. Install the fan in reverse order.

M.2 solid-state drive

- Before you start, ensure that you have read Chapter 1 “Safety requirements for hardware maintenance” on page 1 and “General guidelines” on page 30.
- Make sure the following FRUs (or CRUs) have been removed.

“Lower case” on page 32

Step 1. Lift the corner of the AL foil mylar and disconnect the battery pack cable from the system board. Then, remove one screw and remove the M.2 solid-state drive by pulling it away from the slot.

Attention: Use your fingernail to pull the connector to unplug it. Do not pull the cable.

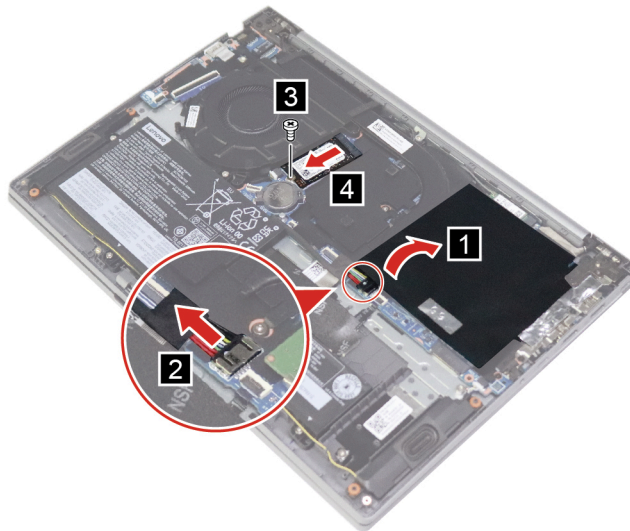

Figure 23. Remove the M.2 solid-state drive

Table 15. Screw used to secure the M.2 solid-state drive

Thread	Length (mm)	Torque (kgf.cm)	Quantity
M2	2	1.85 ± 0.15	1

Step 2. Remove the M.2 solid-state drive thermal pad.

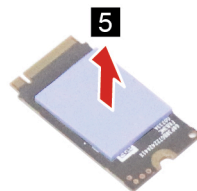

Figure 24. Remove the M.2 solid-state drive thermal pad

Step 3. Install the M.2 SSD and thermal pad in reverse order.

Wi-Fi card

- Before you start, ensure that you have read Chapter 1 “Safety requirements for hardware maintenance” on page 1 and “General guidelines” on page 30.
- Make sure the following FRUs (or CRUs) have been removed.

“Lower case” on page 32

Step 1. Lift the corner of the AL foil mylar and disconnect the battery pack cable from the system board.

Attention: Use your fingernail to pull the connector to unplug it. Do not pull the cable.

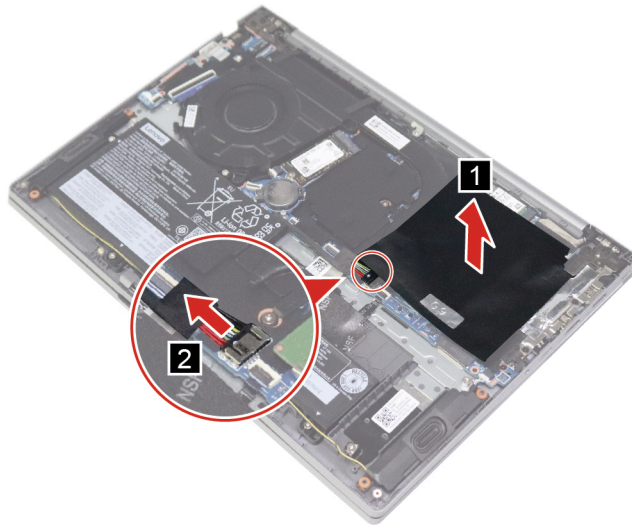

Figure 25. Lift the corner of the AL foil mylar and disconnect the battery pack cable

Step 2. Disconnect the Wi-Fi antennas from the Wi-Fi card, remove one screw, and remove the Wi-Fi card by pulling it away from the slot.

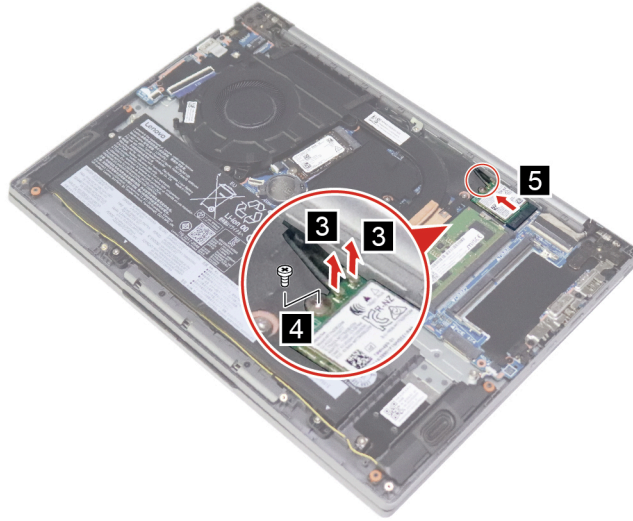

Figure 26. Remove the Wi-Fi card

Table 16. Screw used to secure the Wi-Fi card

Thread	Length (mm)	Torque (kgf.cm)	Quantity
M2	2	1.85 ± 0.15	1

Step 3. Install the Wi-Fi card in reverse order.

CMOS battery

- Before you start, ensure that you have read Chapter 1 “Safety requirements for hardware maintenance” on page 1 and “General guidelines” on page 30.
- Make sure the following FRUs (or CRUs) have been removed.

“Lower case” on page 32

Step 1. Lift the corner of the AL foil mylar and disconnect the battery pack cable from the system board. Then, remove the CMOS battery.

Attention: Use your fingernail to pull the connector to unplug it. Do not pull the cable.

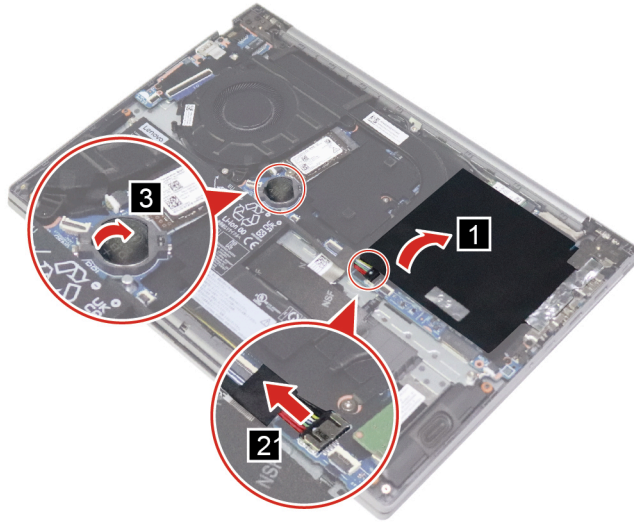

Figure 27. Remove the CMOS battery

Step 2. Install the CMOS battery in reverse order.

Speakers

- Before you start, ensure that you have read Chapter 1 “Safety requirements for hardware maintenance” on page 1 and “General guidelines” on page 30.
- Make sure the following FRUs (or CRUs) have been removed.
 - “Lower case” on page 32

Step 1. Lift the corner of the AL foil mylar and disconnect the battery pack cable from the system board. Then, disconnect the speakers’ cable from the system board, release the speaker’s cable from the cable guide, and remove the speakers.

Attention: Use your fingernail to pull the connector to unplug it. Do not pull the cable.

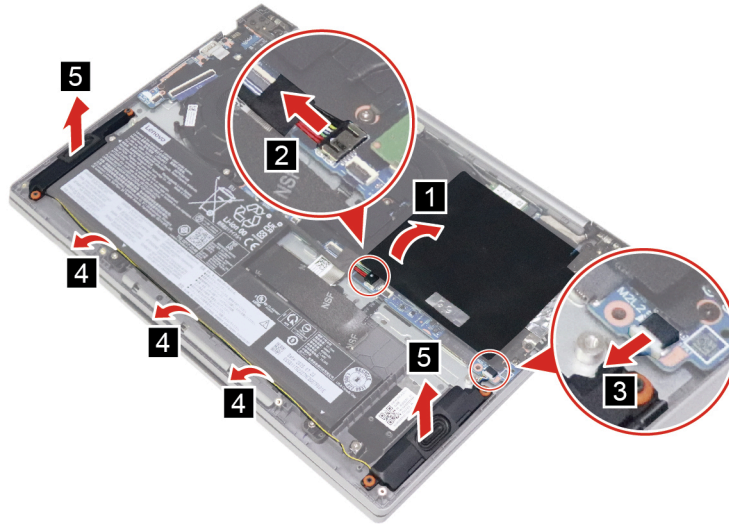

Figure 28. Remove the speakers

Step 2. Install the speakers in reverse order.

I/O bracket

- Before you start, ensure that you have read Chapter 1 “Safety requirements for hardware maintenance” on page 1 and “General guidelines” on page 30.
- Make sure the following FRUs (or CRUs) have been removed.
 - “Lower case” on page 32

Step 1. Remove the AL foil mylar and disconnect the battery pack cable from the system board.

Attention: Use your fingernail to pull the connector to unplug it. Do not pull the cable.

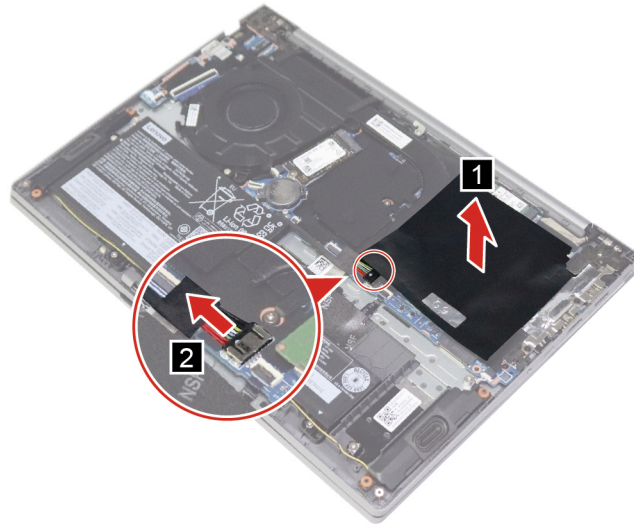

Figure 29. Remove the AL foil mylar and disconnect the battery pack cable

Step 2. Remove three screws and lift the right hinge. Then, remove two screws and remove the I/O bracket.

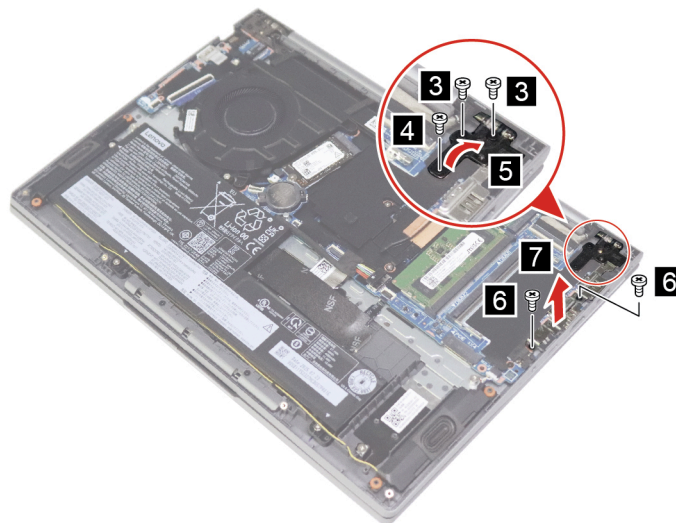

Figure 30. Remove the I/O bracket

Table 17. Screws used to secure the hinge and I/O bracket

Label	Thread	Length (mm)	Torque (kgf.cm)	Quantity
3	M2	6	3.0 ± 0.3	2
4	M2	4	1.85 ± 0.15	1
6	M2	4	1.85 ± 0.15	2

Step 3. Install the I/O bracket in reverse order.

System board

System board (14-inch models)

- Before you start, ensure that you have read Chapter 1 “Safety requirements for hardware maintenance” on page 1 and “General guidelines” on page 30.
- Make sure the following FRUs (or CRUs) have been removed.
 - “Lower case” on page 32
 - “Memory module” on page 40
 - “Heat sink (14-inch models)” on page 41
 - “Fan (14-inch models)” on page 46
 - “M.2 solid-state drive” on page 49
 - “Wi-Fi card” on page 50
 - “CMOS battery” on page 51
 - “I/O bracket” on page 53

Step 1. Disconnect the I/O board cable from the I/O board. Disconnect the keyboard backlight cable, keyboard cable, touchpad board cable, speakers' cable, and EDP cable from the system board.

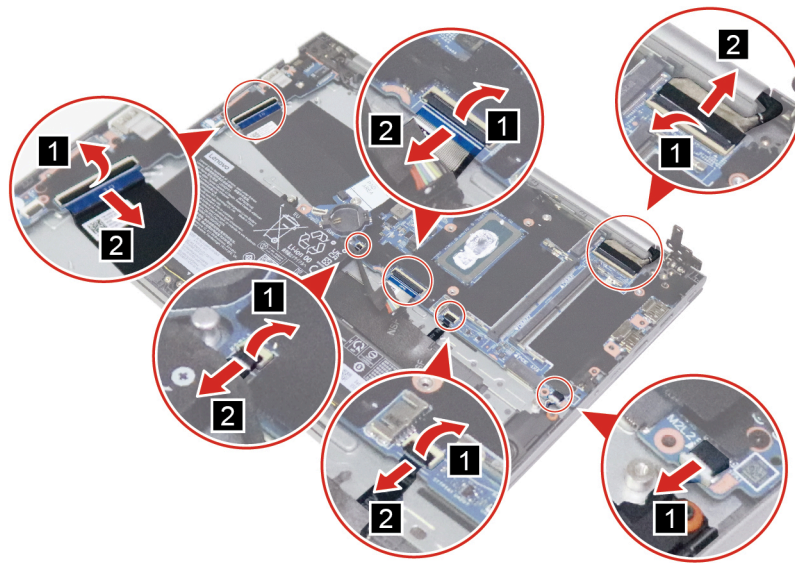

Figure 31. Disconnect cables

Step 2. Remove one screw and remove the system board.

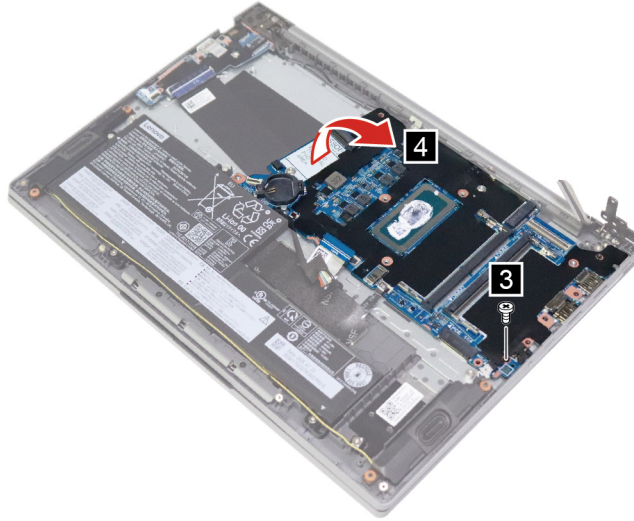

Figure 32. Remove one screw and remove the system board

Table 18. Screw used to secure the system board

Thread	Length (mm)	Torque (kgf.cm)	Quantity
M2	4	1.85 ± 0.15	1

Step 3. Disconnect the I/O board cable from the system board.

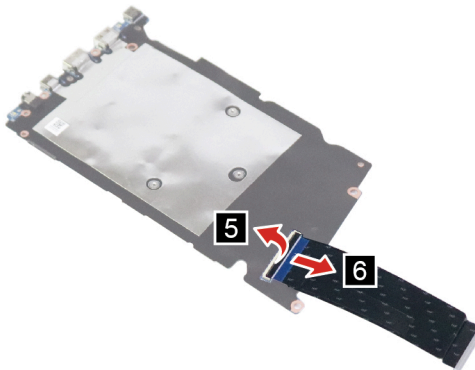

Figure 33. Disconnect the I/O board cable from the system board

Step 4. Install the system board in reverse order.

System board (16-inch models)

- Before you start, ensure that you have read Chapter 1 “Safety requirements for hardware maintenance” on page 1 and “General guidelines” on page 30.
- Make sure the following FRUs (or CRUs) have been removed.
 - “Lower case” on page 32

- “Memory module” on page 40
- “Heat sink (16-inch models)” on page 43
- “Fan (16-inch models)” on page 47
- “M.2 solid-state drive” on page 49
- “Wi-Fi card” on page 50
- “CMOS battery” on page 51
- “I/O bracket” on page 53

Step 1. Disconnect the I/O board cable from the I/O board. Disconnect the keyboard backlight cable, keyboard cable, touchpad board cable, speakers' cable, and EDP cable from the system board.

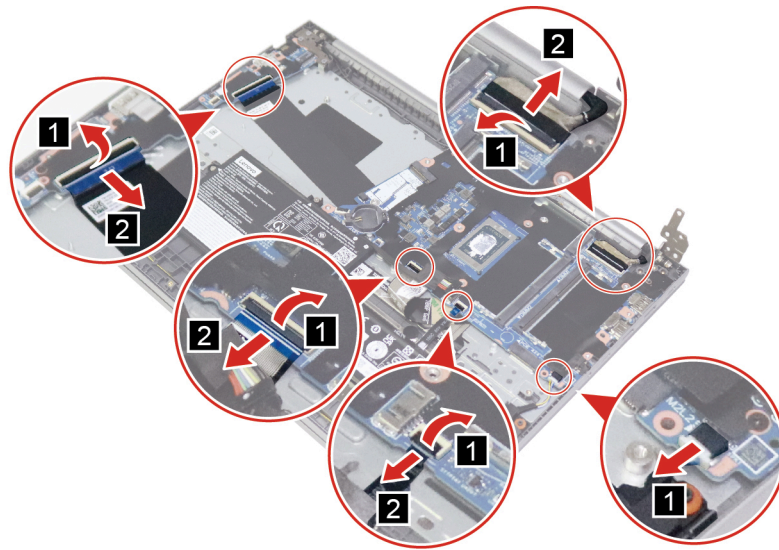

Figure 34. Disconnect cables

Step 2. Remove one screw and remove the system board.

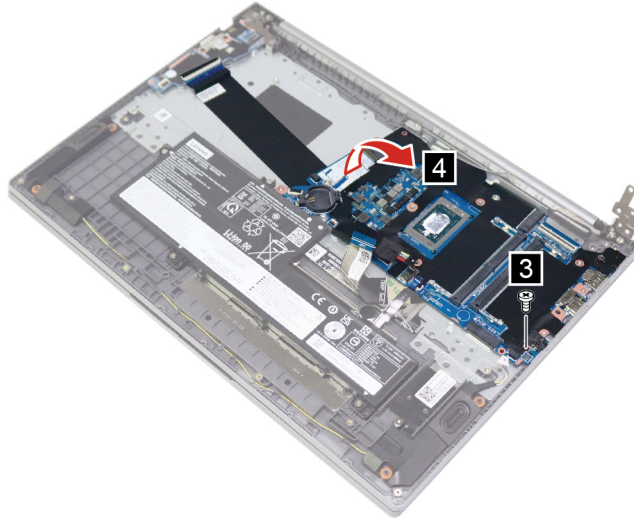

Figure 35. Remove one screw and remove the system board

Table 19. Screw used to secure the system board

Thread	Length (mm)	Torque (kgf.cm)	Quantity
M2	4	1.85 ± 0.15	1

Step 3. Disconnect the I/O board cable from the system board.

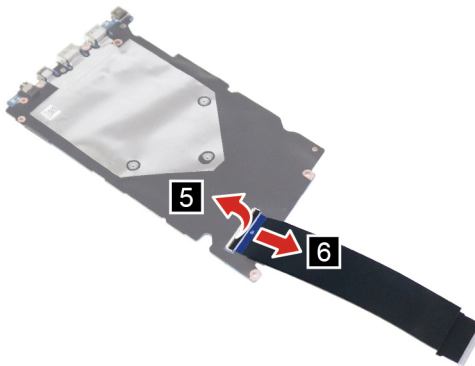

Figure 36. Disconnect the I/O board cable from the system board

Step 4. Install the system board in reverse order.

Write key product information to a replacement system board

Some key product information and settings are stored in the ROMs of the PC's system board. The information and settings are essential for using and servicing a Lenovo PC. After replacing a system board for a Lenovo PC, you need to use a Lenovo-provided software tool to write key information—including machine type model (MTM), serial number (SN), and product name—as well as settings such as keyboard language to the replacement system board.

For service technicians, go to <https://support.lenovo.com/us/en/solutions/ht102004> for detailed instructions on how to create and use a Golden Key U1 tool or a normal BIOS tool.

For users, follow the following steps:

Attention: Take extra caution when entering the MTM and SN and when selecting the product name and keyboard language. Carefully verify these details before committing the writing action. Once recorded on the system board, they cannot be altered. Consult Lenovo service if you are uncertain about the MTM, SN, and product name for your PC.

- Step 1. Connect the ac power adapter and turn on the computer.
- Step 2. Download the tool package and double-click the WinMBDWizard.exe file to run the tool. To download the tool, go to <https://support.lenovo.com/solutions/HT516532>.
- Step 3. Follow the on-screen instructions to input the MTM and SN, select the product name and keyboard language of the computer.
- Step 4. Click **Start Update** to update the product information.
- Step 5. Click **Yes** in the confirmation window to continue the update.
- Step 6. Click **Finish** to close the tool.
- Step 7. Click **Yes** in the confirmation window to restart the computer and apply the configuration on the system board.

Note: Do not turn off the computer or disconnect the computer from ac power during the whole process.

I/O board

I/O board (14-inch models)

- Before you start, ensure that you have read Chapter 1 “Safety requirements for hardware maintenance” on page 1 and “General guidelines” on page 30.
- Make sure the following FRUs (or CRUs) have been removed.
 - “Lower case” on page 32
 - “Memory module” on page 40
 - “Heat sink (14-inch models)” on page 41
 - “Fan (14-inch models)” on page 46
 - “M.2 solid-state drive” on page 49
 - “Wi-Fi card” on page 50
 - “CMOS battery” on page 51
 - “I/O bracket” on page 53
 - “System board (14-inch models)” on page 55

- Step 1. Release the Wi-Fi antennas from the cable guide. Then, remove three screws and lift the left hinge.

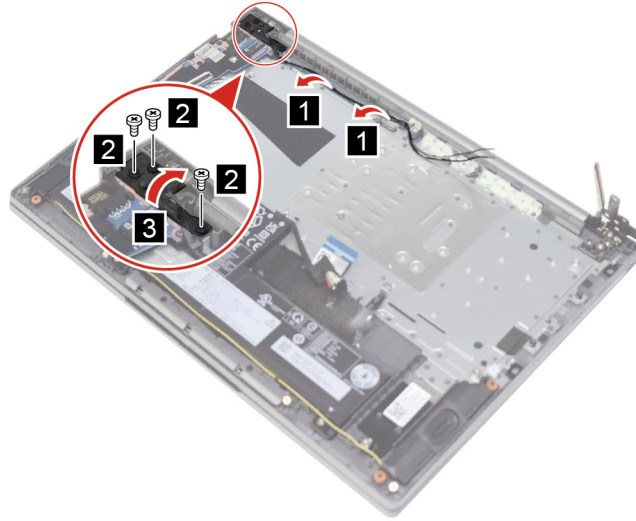

Figure 37. Release the Wi-Fi antennas, remove three screws, and lift the left hinge

Table 20. Screws used to secure the hinge

Thread	Length (mm)	Torque (kgf.cm)	Quantity
M2.5	6	3.0 ± 0.3	3

Step 2. Remove three screws and remove the I/O board.

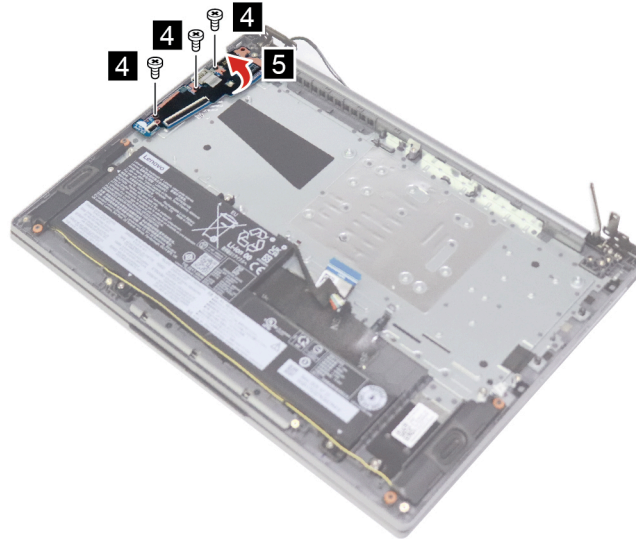

Figure 38. Remove three screws and the I/O board

Table 21. Screws used to secure the I/O board

Thread	Length (mm)	Torque (kgf.cm)	Quantity
M2	4	1.85 ± 0.15	3

Step 3. Install the I/O board in reverse order.

I/O board (16-inch models)

- Before you start, ensure that you have read Chapter 1 “Safety requirements for hardware maintenance” on page 1 and “General guidelines” on page 30.
- Make sure the following FRUs (or CRUs) have been removed.
 - “Lower case” on page 32

Step 1. Lift the corner of the AL foil mylar and disconnect the battery pack cable from the system board.

Attention: Use your fingernail to pull the connector to unplug it. Do not pull the cable.

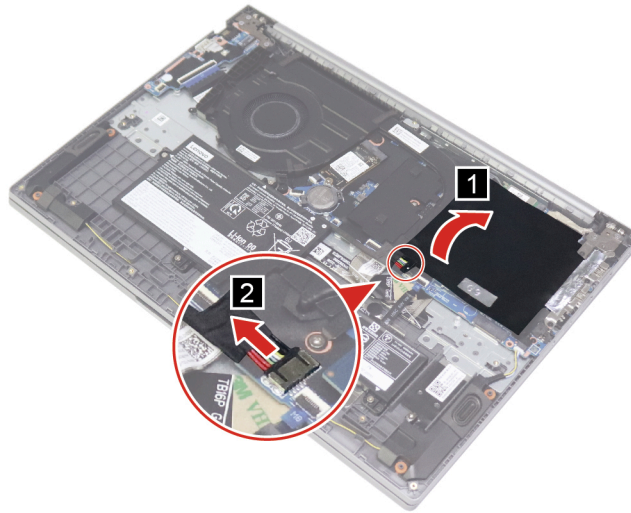

Figure 39. Lift the corner of the AL foil mylar and disconnect the battery pack cable

Step 2. Remove three screws and lift the left hinge.

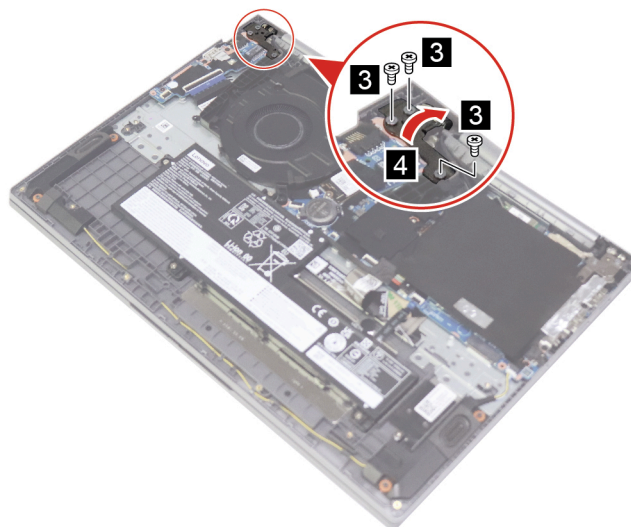

Figure 40. Remove three screws and lift the left hinge

Table 22. Screws used to secure the hinge

Thread	Length (mm)	Torque (kgf.cm)	Quantity
M2.5	7	3.0 ± 0.3	3

Step 3. Disconnect the I/O board cable from the I/O board.

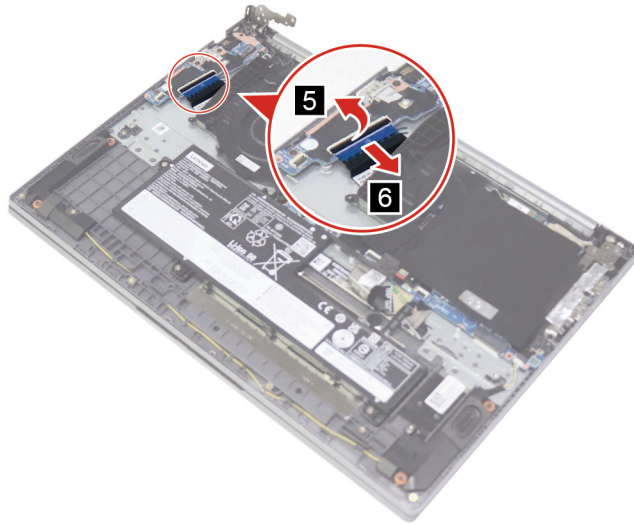

Figure 41. Disconnect the I/O board cable

Step 4. Remove three screws and remove the I/O board.

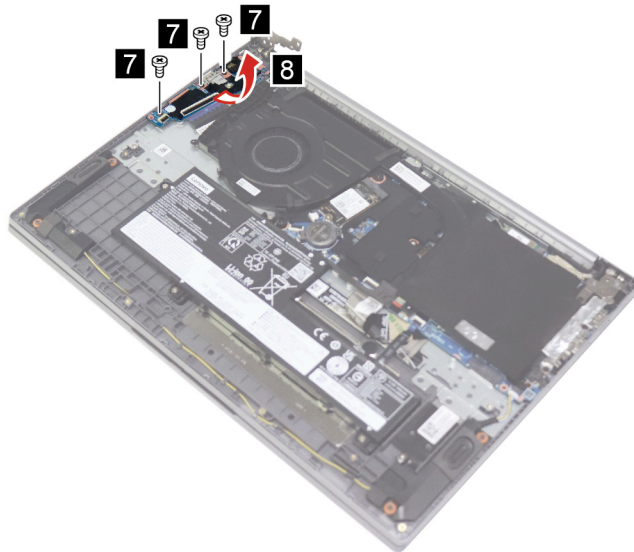

Figure 42. Remove three screws and the I/O board

Table 23. Screws used to secure the I/O board

Thread	Length (mm)	Torque (kgf.cm)	Quantity
M2	4	1.85 ± 0.15	3

Step 5. Install the I/O board in reverse order.

Power button (for selected models)

Power button (14-inch models)

- Before you start, ensure that you have read Chapter 1 “Safety requirements for hardware maintenance” on page 1 and “General guidelines” on page 30.
- Make sure the following FRUs (or CRUs) have been removed.
 - “Lower case” on page 32
 - “Memory module” on page 40
 - “Heat sink (14-inch models)” on page 41
 - “Fan (14-inch models)” on page 46
 - “M.2 solid-state drive” on page 49
 - “Wi-Fi card” on page 50
 - “CMOS battery” on page 51
 - “I/O bracket” on page 53
 - “System board (14-inch models)” on page 55
 - “I/O board (14-inch models)” on page 59

Step 1. Remove the power button.

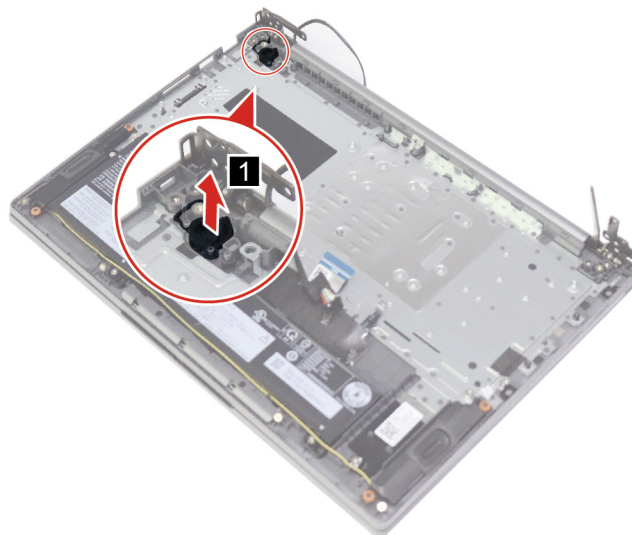

Figure 43. Remove the power button

Step 2. Install the power button in reverse order.

Power button (16-inch models)

- Before you start, ensure that you have read Chapter 1 “Safety requirements for hardware maintenance” on page 1 and “General guidelines” on page 30.
- Make sure the following FRUs (or CRUs) have been removed.
 - “Lower case” on page 32
 - “I/O board (16-inch models)” on page 61

Step 1. Remove the power button.

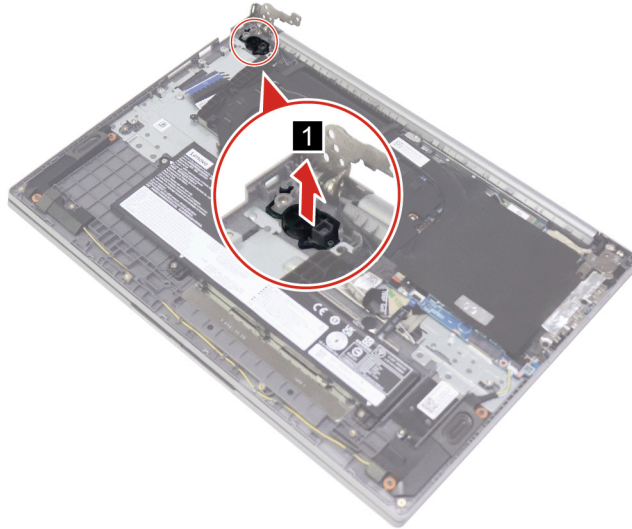

Figure 44. Remove the power button

Step 2. Install the power button in reverse order.

Fingerprint sensor board (for selected models)

Fingerprint sensor board (14-inch models)

- Before you start, ensure that you have read Chapter 1 “Safety requirements for hardware maintenance” on page 1 and “General guidelines” on page 30.
- Make sure the following FRUs (or CRUs) have been removed.
 - “Lower case” on page 32
 - “Memory module” on page 40
 - “Heat sink (14-inch models)” on page 41
 - “Fan (14-inch models)” on page 46
 - “M.2 solid-state drive” on page 49
 - “Wi-Fi card” on page 50
 - “CMOS battery” on page 51
 - “I/O bracket” on page 53
 - “System board (14-inch models)” on page 55

“I/O board (14-inch models)” on page 59

Step 1. Lift the power button area first. Then, use a pry tool to insert into the groove to lift and remove the fingerprint sensor board.

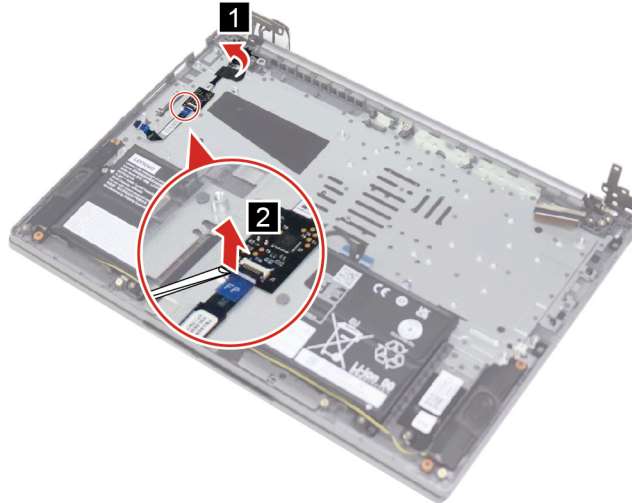

Figure 45. Lift and remove the fingerprint sensor board

Step 2. Disconnect and remove the fingerprint sensor cable from the fingerprint sensor board.

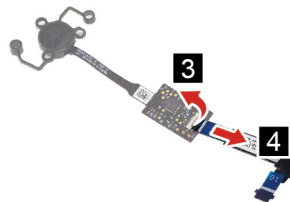

Figure 46. Disconnect and remove the fingerprint sensor cable

Step 3. Install the fingerprint sensor board and fingerprint sensor cable in reverse order.

Fingerprint sensor board (16-inch models)

- Before you start, ensure that you have read Chapter 1 “Safety requirements for hardware maintenance” on page 1 and “General guidelines” on page 30.
- Make sure the following FRUs (or CRUs) have been removed.

“Lower case” on page 32

“I/O board (16-inch models)” on page 61

Step 1. Lift the power button area first. Then, use a pry tool to insert into the groove to lift and remove the fingerprint sensor board.

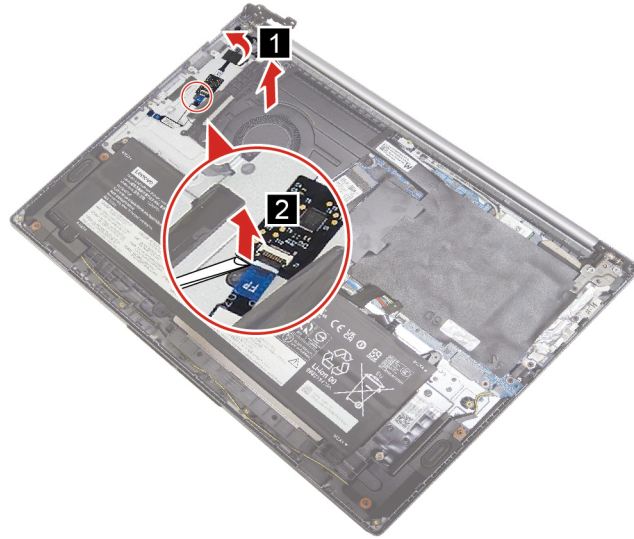

Figure 47. Lift and remove the fingerprint sensor board

Step 2. Disconnect and remove the fingerprint sensor cable from the fingerprint sensor board.

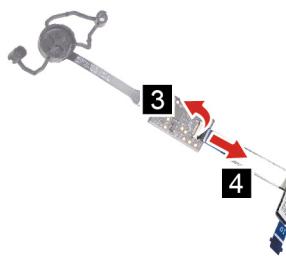

Figure 48. Disconnect and remove the fingerprint sensor cable

Step 3. Install the fingerprint sensor board and fingerprint sensor cable in reverse order.

LCD module

LCD Module (14-inch models)

- Before you start, ensure that you have read Chapter 1 “Safety requirements for hardware maintenance” on page 1 and “General guidelines” on page 30.
- Make sure the following FRUs (or CRUs) have been removed.
 - “Lower case” on page 32
 - “Memory module” on page 40
 - “Heat sink (14-inch models)” on page 41
 - “Fan (14-inch models)” on page 46
 - “M.2 solid-state drive” on page 49
 - “Wi-Fi card” on page 50

“CMOS battery” on page 51

“I/O bracket” on page 53

“System board (14-inch models)” on page 55

Step 1. Release the Wi-Fi antennas from the cable guide. Then, remove three screws and lift the left hinge.

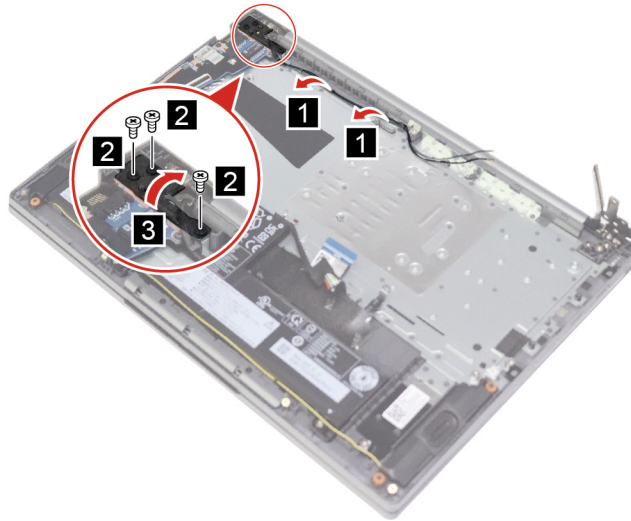

Figure 49. Release the Wi-Fi antennas, remove three screws, and lift the left hinge

Table 24. Screws used to secure the hinge

Thread	Length (mm)	Torque (kgf.cm)	Quantity
M2.5	6	3.0 ± 0.3	3

Step 2. Rotate the LCD module to an angle of more than 90 degrees and remove the LCD module.

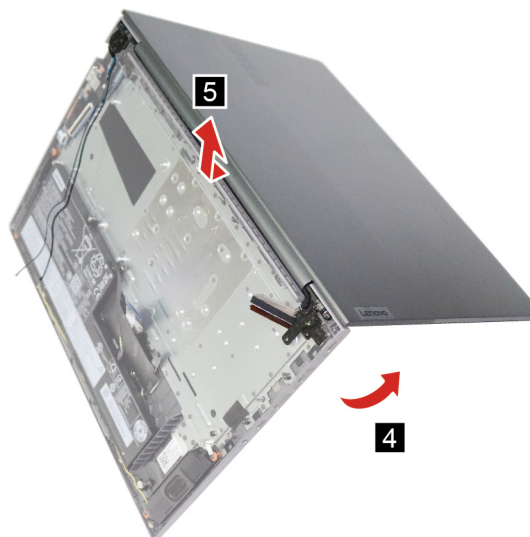

Figure 50. Rotate and remove LCD module

Step 3. Install the LCD module in reverse order.

LCD Module (16-inch models)

- Before you start, ensure that you have read Chapter 1 “Safety requirements for hardware maintenance” on page 1 and “General guidelines” on page 30.
- Make sure the following FRUs (or CRUs) have been removed.

“Lower case” on page 32

Step 1. Disconnect the Wi-Fi antennas from the Wi-Fi card and release the Wi-Fi antennas from the cable guide. Disconnect the EDP cable from the system board.

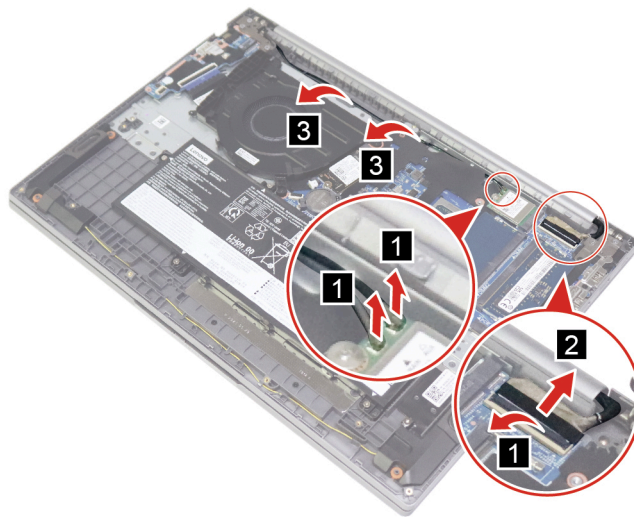

Figure 51. Disconnect the Wi-Fi antennas and EDP cable

Step 2. Remove six screws.

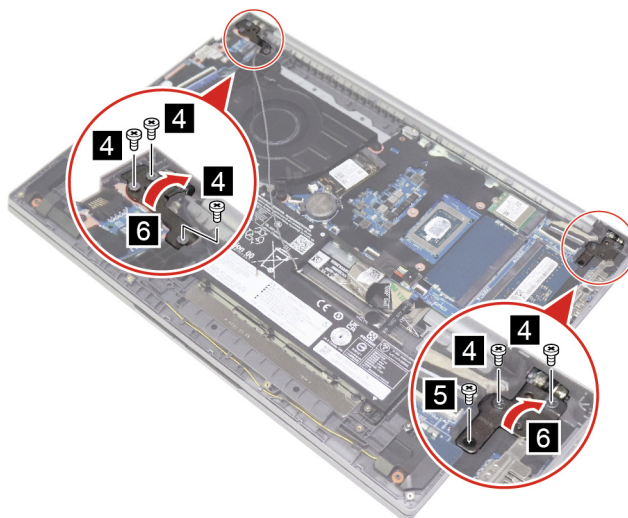

Figure 52. Remove six screws

Table 25. Screws used to secure the hinge

Label	Thread	Length (mm)	Torque (kgf.cm)	Quantity
4	M2.5	7	3.0 ± 0.3	5
5	M2	4	1.85 ± 0.15	1

Step 3. Rotate the LCD module to an angle of more than 90 degrees and remove the LCD module.

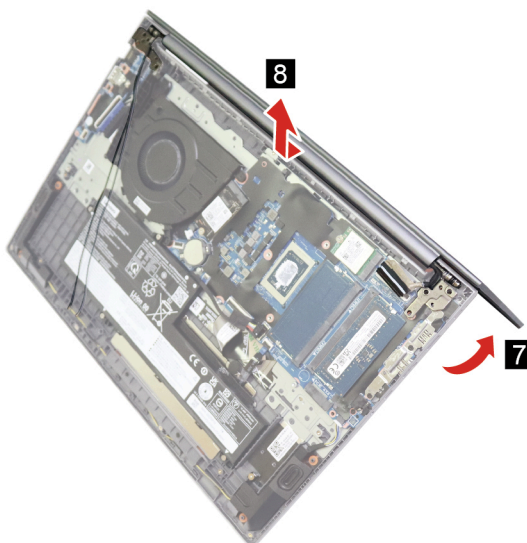

Figure 53. Rotate and remove LCD module

Step 4. Install the LCD module in reverse order.

LCD Self Test

When you turn on the computer and the LCD goes black, run LCD Self Test to help you determine whether the LCD functions normally.

To run LCD Self Test:

Ensure that the computer is connected to ac power. Then, press the power button for about seven seconds to turn off the computer.

Press Fn, left Ctrl, and the power button at the same time. If the computer displays five solid colors in sequence across the entire screen, it indicates that the LCD functions normally.

The test lasts for about 20 seconds and then exits automatically. You also can press the power button to exit the test.

Upper case (with keyboard)

- Before you start, ensure that you have read Chapter 1 “Safety requirements for hardware maintenance” on page 1 and “General guidelines” on page 30.

Step 1. Remove the following FRUs (or CRUs).

“Lower case” on page 32

“Battery pack” on page 35

“Touchpad board cable” on page 38

“Memory module” on page 40

“Heat sink” on page 41

“Fan” on page 46

“M.2 solid-state drive” on page 49

“Wi-Fi card” on page 50

“CMOS battery” on page 51

“Speakers” on page 52

“I/O bracket” on page 53

“System board” on page 55

“I/O board” on page 59

“Power button (for selected models)” on page 63

“Fingerprint sensor board (for selected models)” on page 64

“LCD module” on page 66

Step 2. Install the upper case (with keyboard) in reverse order.

Disassemble the LCD module

Before disassembling the LCD module, make sure it has been detached from the upper case assembly.

Hinge cover

- Before you start, ensure that you have read Chapter 1 “Safety requirements for hardware maintenance” on page 1 and “General guidelines” on page 30.

- Make sure the following FRUs (or CRUs) have been removed.
 - “Lower case” on page 32
 - “LCD module” on page 66

Step 1. Push right to remove the hinge cover.

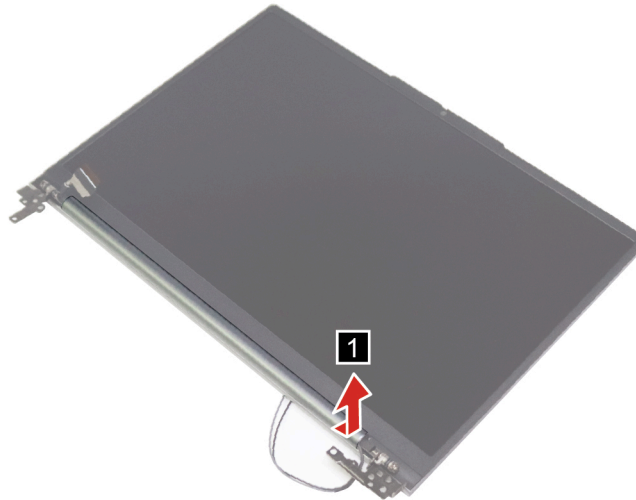

Figure 54. Remove the hinge cover

Step 2. Install the hinge cover in reverse order.

LCD bezel

- Before you start, ensure that you have read Chapter 1 “Safety requirements for hardware maintenance” on page 1 and “General guidelines” on page 30.
- Make sure the following FRUs (or CRUs) have been removed.
 - “Lower case” on page 32
 - “LCD module” on page 66
 - “Hinge cover” on page 70

Step 1. Remove three screws and remove the LCD bezel.

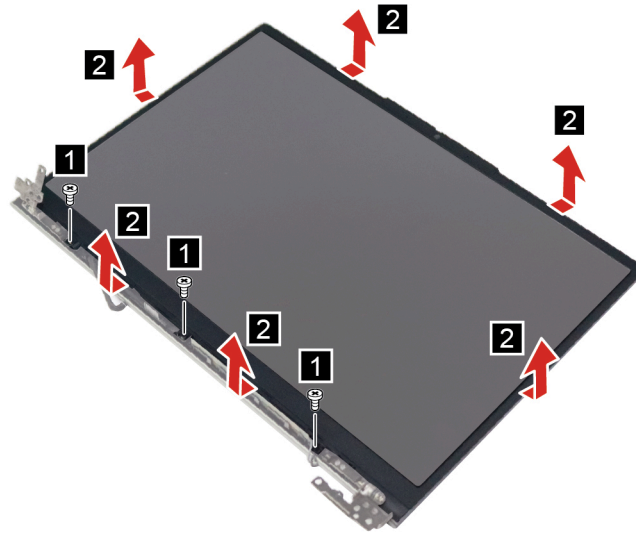

Figure 55. Remove three screws and the LCD bezel

Table 26. Screws used to secure the LCD bezel

Thread	Length (mm)	Torque (kgf.cm)	Quantity
M2	4	1.85 ± 0.15	3

Step 2. Install the LCD bezel in reverse order.

Hinges

- Before you start, ensure that you have read Chapter 1 “Safety requirements for hardware maintenance” on page 1 and “General guidelines” on page 30.
- Make sure the following FRUs (or CRUs) have been removed.
 - “Lower case” on page 32
 - “LCD module” on page 66
 - “Hinge cover” on page 70
 - “LCD bezel” on page 71

Step 1. Remove six screws and remove the hinges.

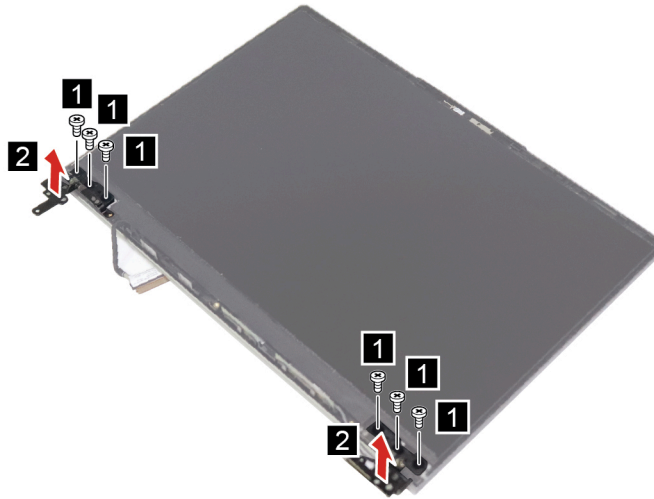

Figure 56. Remove six screws and the hinges

Table 27. Screws used to secure the hinges

Thread	Length (mm)	Torque (kgf.cm)	Quantity
M2	2	1.85 ± 0.15	6

Step 2. Install the hinges in reverse order.

Mic rubbers

- Before you start, ensure that you have read Chapter 1 “Safety requirements for hardware maintenance” on page 1 and “General guidelines” on page 30.
- Make sure the following FRUs (or CRUs) have been removed.
 - “Lower case” on page 32
 - “LCD module” on page 66
 - “Hinge cover” on page 70
 - “LCD bezel” on page 71

Step 1. Remove the mic rubbers.

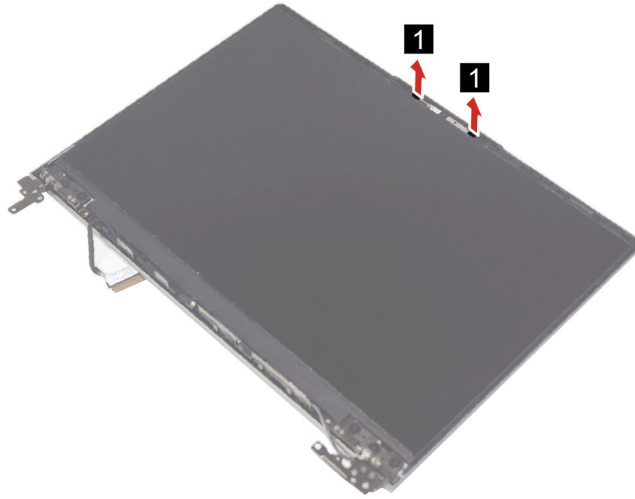

Figure 57. Remove the mic rubbers

Step 2. Install the mic rubbers in reverse order.

LCD panel

- Before you start, ensure that you have read Chapter 1 “Safety requirements for hardware maintenance” on page 1 and “General guidelines” on page 30.
- Make sure the following FRUs (or CRUs) have been removed.
 - “Lower case” on page 32
 - “LCD module” on page 66
 - “LCD bezel” on page 71
 - “Hinge cover” on page 70

Step 1. Use tweezers to pull out two pieces of the removable tape and lift the LCD panel.

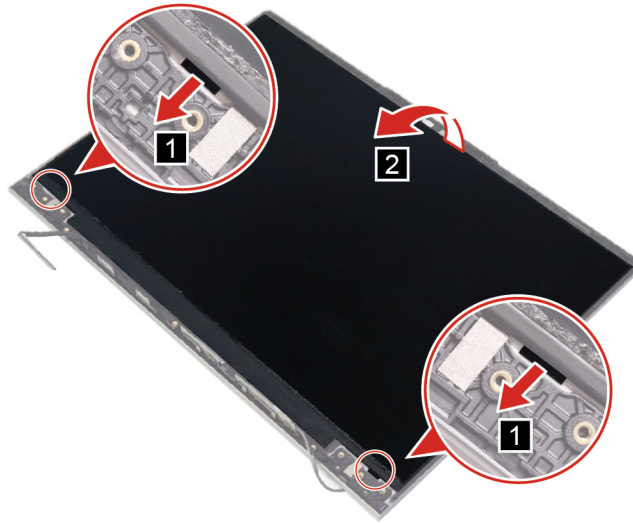

Figure 58. Pull out two pieces of the removable tapes and lift the LCD panel

Step 2. Peel back the mylar tape and disconnect the EDP cable from the LCD panel. Then, remove the LCD panel.

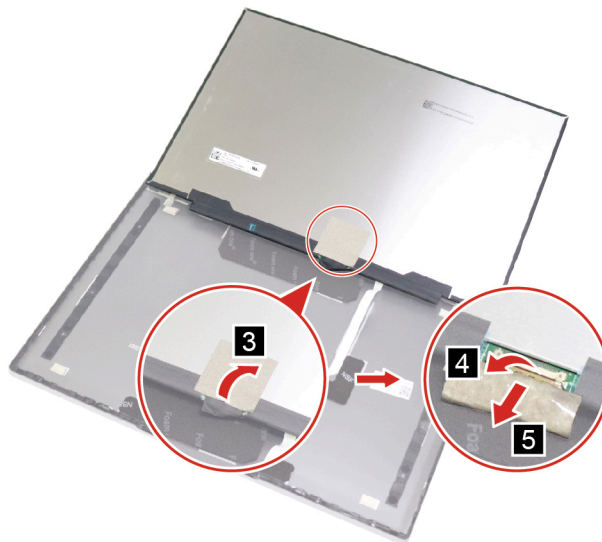

Figure 59. Disconnect the EDP cable and remove the LCD panel

Antennas

- Before you start, ensure that you have read Chapter 1 “Safety requirements for hardware maintenance” on page 1 and “General guidelines” on page 30.
- Make sure the following FRUs (or CRUs) have been removed.
 - “Lower case” on page 32
 - “LCD module” on page 66
 - “Hinge cover” on page 70

“LCD bezel” on page 71

“LCD panel” on page 74

Step 1. Detach and remove the antennas.

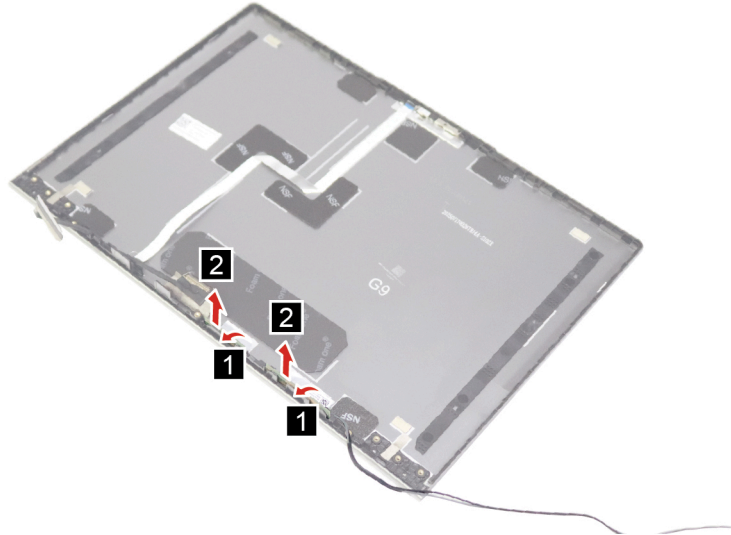

Figure 60. Remove the antennas

Step 2. Install the antennas in reverse order.

Camera board

- Before you start, ensure that you have read Chapter 1 “Safety requirements for hardware maintenance” on page 1 and “General guidelines” on page 30.
- Make sure the following FRUs (or CRUs) have been removed.
 - “Lower case” on page 32
 - “LCD module” on page 66
 - “Hinge cover” on page 70
 - “LCD bezel” on page 71
 - “LCD panel” on page 74

Step 1. Disconnect the EDP cable from the camera board and remove the camera board.

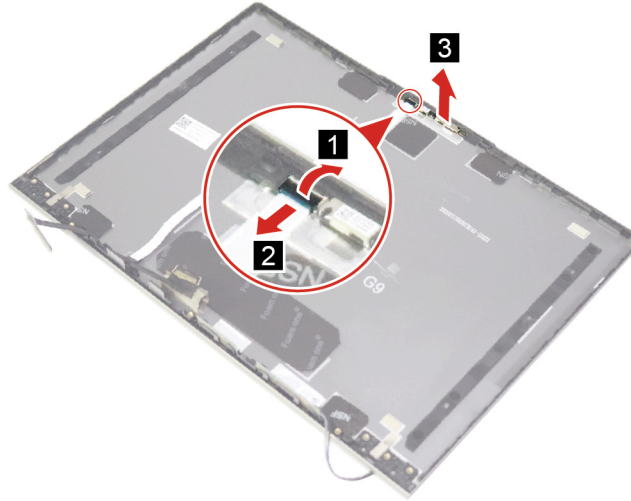

Figure 61. Disconnect the EDP cable and remove the camera board

Step 2. Install the camera board in reverse order.

EDP cable

- Before you start, ensure that you have read Chapter 1 “Safety requirements for hardware maintenance” on page 1 and “General guidelines” on page 30.
- Make sure the following FRUs (or CRUs) have been removed.
 - “Lower case” on page 32
 - “LCD module” on page 66
 - “Hinge cover” on page 70
 - “LCD bezel” on page 71
 - “LCD panel” on page 74

Step 1. Disconnect the EDP cable from the camera board and remove the EDP cable.

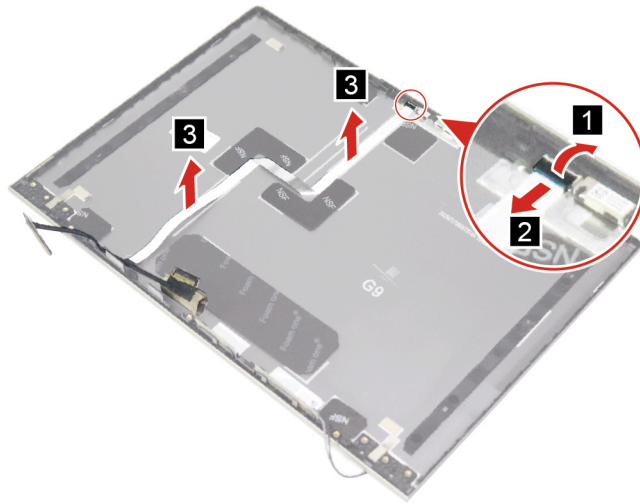

Figure 62. Disconnect and remove the EDP cable

Step 2. Install the EDP cable in reverse order.

LCD cover

- Before you start, ensure that you have read Chapter 1 “Safety requirements for hardware maintenance” on page 1 and “General guidelines” on page 30.

Step 1. Remove the following FRUs (or CRUs).

- “Lower case” on page 32
- “LCD module” on page 66
- “Hinge cover” on page 70
- “LCD bezel” on page 71
- “Hinges” on page 72
- “Mic rubbers” on page 73
- “LCD panel” on page 74
- “Antennas” on page 75
- “Camera board” on page 76
- “EDP cable” on page 77

Step 2. Install the LCD cover in reverse order.

Appendix A. Important notice for Quebec consumers

In regard to section 79.18 of Quebec's Regulation respecting the application of the Consumer Protection Act, Lenovo in no way guarantees the availability of (a) replacement parts; (b) repair services; and (c) information necessary to maintain or repair the goods. For up-to-date information on the technical support and parts available for your purchase, please consult <https://support.lenovo.com/ca/en>.

En ce qui concerne l'article 79.18 du Règlement d'application de la Loi sur la protection du consommateur du Québec, Lenovo ne garantit en aucune façon la disponibilité des éléments suivants : (a) les pièces de rechange ; (b) les services de réparation ; et (c) les renseignements nécessaires à l'entretien à la réparation du bien. Pour obtenir des renseignements à jour sur le soutien technique et les pièces disponibles pour votre achat, veuillez consulter <https://support.lenovo.com/ca/fr>.

Appendix B. Self-help resources

Use the following self-help resources to learn more about the computer and troubleshoot problems.

Resources	How to access?
Troubleshooting and frequently asked questions	<ul style="list-style-type: none">• https://www.lenovo.com/tips• https://forums.lenovo.com
Accessibility information	https://www.lenovo.com/accessibility
Reset or restore Windows	<ul style="list-style-type: none">• Use Lenovo recovery options.<ol style="list-style-type: none">1. Go to https://support.lenovo.com/HowToCreateLenovoRecovery.2. Follow the on-screen instructions.• Use Windows recovery options.<ol style="list-style-type: none">1. Go to https://pcsupport.lenovo.com.2. Detect your computer or manually select your computer model.3. Click Troubleshoot & Diagnose → Custom Troubleshooting → Operating System Diagnostics and then follow the on-screen instructions.
Use Lenovo Vantage or Lenovo Baiying to: <ul style="list-style-type: none">• Download and install the latest drivers and firmware.• Configure hardware settings.• Diagnose computer hardware problems.• Check the computer warranty status.	Use Windows Search.
Product documentation: <ul style="list-style-type: none">• Generic Safety and Compliance Notices• <i>Safety and Warranty Guide</i>• <i>Setup Guide</i>• <i>User Guide</i>• This <i>Hardware Maintenance Manual</i>• <i>Regulatory Notice</i>	Go to Lenovo Documentation Center and search by product.

Resources	How to access?
Lenovo Support Web site with the latest support information on the following:	Visit https://support.lenovo.com .
<ul style="list-style-type: none"> • Drivers and software • Diagnostic solutions • Product and service warranty • Product and parts details • Knowledge base and frequently asked questions 	
Windows help information	<ul style="list-style-type: none"> • Use Get Help or Tips. • Use Windows Search. • Microsoft Support Web site: https://support.microsoft.com

Trademarks

LENOVO and the LENOVO logo are trademarks of Lenovo.

All other trademarks are the property of their respective owners. © 2025 Lenovo.

