

P10S-M

ASUS[®]

Motherboard

Copyright © 2017 ASUSTeK COMPUTER INC. All Rights Reserved.

No part of this manual, including the products and software described in it, may be reproduced, transmitted, transcribed, stored in a retrieval system, or translated into any language in any form or by any means, except documentation kept by the purchaser for backup purposes, without the express written permission of ASUSTeK COMPUTER INC. ("ASUS").

Product warranty or service will not be extended if: (1) the product is repaired, modified or altered, unless such repair, modification or alteration is authorized in writing by ASUS; or (2) the serial number of the product is defaced or missing.

ASUS PROVIDES THIS MANUAL "AS IS" WITHOUT WARRANTY OF ANY KIND, EITHER EXPRESS OR IMPLIED, INCLUDING BUT NOT LIMITED TO THE IMPLIED WARRANTIES OR CONDITIONS OF MERCHANTABILITY OR FITNESS FOR A PARTICULAR PURPOSE. IN NO EVENT SHALL ASUS, ITS DIRECTORS, OFFICERS, EMPLOYEES OR AGENTS BE LIABLE FOR ANY INDIRECT, SPECIAL, INCIDENTAL, OR CONSEQUENTIAL DAMAGES (INCLUDING DAMAGES FOR LOSS OF PROFITS, LOSS OF BUSINESS, LOSS OF USE OR DATA, INTERRUPTION OF BUSINESS AND THE LIKE), EVEN IF ASUS HAS BEEN ADVISED OF THE POSSIBILITY OF SUCH DAMAGES ARISING FROM ANY DEFECT OR ERROR IN THIS MANUAL OR PRODUCT.

SPECIFICATIONS AND INFORMATION CONTAINED IN THIS MANUAL ARE FURNISHED FOR INFORMATIONAL USE ONLY, AND ARE SUBJECT TO CHANGE AT ANY TIME WITHOUT NOTICE, AND SHOULD NOT BE CONSTRUED AS A COMMITMENT BY ASUS. ASUS ASSUMES NO RESPONSIBILITY OR LIABILITY FOR ANY ERRORS OR INACCURACIES THAT MAY APPEAR IN THIS MANUAL, INCLUDING THE PRODUCTS AND SOFTWARE DESCRIBED IN IT.

Products and corporate names appearing in this manual may or may not be registered trademarks or copyrights of their respective companies, and are used only for identification or explanation and to the owners' benefit, without intent to infringe.

Contents

Notices	vii
Federal Communications Commission Statement	vii
REACH	viii
Australia statement notice	viii
Safety information	ix
Electrical safety	ix
Operation safety	ix
P10S-M Specifications Summary	xi
Chapter 1: Product Introduction	
1.1 Welcome!	1-2
1.2 Package contents	1-2
1.3 Serial number label	1-3
1.4 Special features	1-3
1.4.1 Product highlights	1-3
1.4.2 Innovative ASUS features	1-4
Chapter 2: Hardware Information	
2.1 Before you proceed	2-2
2.2 Motherboard overview	2-3
2.2.1 Placement direction	2-3
2.2.2 Screw holes	2-3
2.2.3 Motherboard layout	2-4
2.2.4 Layout contents	2-5
2.3 Central Processing Unit (CPU)	2-7
2.3.1 Installing the CPU	2-7
2.3.2 Installing the CPU heatsink	2-10
2.3.3 Uninstalling the CPU heatsink and fan	2-11
2.3.4 Installing the CPU heatsink in rack	2-12
2.4 System memory	2-13
2.4.1 Overview	2-13
2.4.2 Memory configurations	2-13
2.4.3 Installing a DIMM on a single clip DIMM socket	2-14

Contents

- 2.5 Expansion slots.....2-15**
 - 2.5.1 Installing an expansion card.....2-15
 - 2.5.2 Configuring an expansion card2-15
 - 2.5.3 Interrupt assignments.....2-16
 - 2.5.4 PCI Express x8 slot (x8 link)2-16
 - 2.5.5 PCI Express x16 slot (x8 link)2-16
 - 2.5.6 PCI Express x8 slot (x4 link)2-16
 - 2.5.7 PCI Express x8 slot (x4 link)2-16
 - 2.5.8 Installing the Baseboard Management Card.....2-18
- 2.6 Onboard LEDs2-19**
- 2.7 Jumpers2-25**
- 2.8 Connectors2-29**
 - 2.8.1 Rear panel connectors.....2-29
 - 2.8.2 Internal connectors.....2-31

Chapter 3: Powering Up

- 3.1 Starting up for the first time.....3-2**
- 3.2 Powering off the computer.....3-3**
 - 3.2.1 Using the OS shut down function.....3-3
 - 3.2.2 Using the dual function power switch.....3-3

Chapter 4: BIOS Setup

- 4.1 Managing and updating your BIOS4-2**
 - 4.1.1 ASUS CrashFree BIOS 3 utility.....4-2
 - 4.1.2 ASUS EzFlash Utility.....4-3
 - 4.1.3 BUPDATER utility4-4
- 4.2 BIOS setup program4-6**
 - 4.2.1 BIOS menu screen.....4-7
 - 4.2.2 Menu bar4-7
 - 4.2.3 Menu items.....4-8
 - 4.2.4 Submenu items4-8
 - 4.2.5 Navigation keys.....4-8
 - 4.2.6 General help.....4-8
 - 4.2.7 Configuration fields4-8
 - 4.2.8 Pop-up window.....4-8
 - 4.2.9 Scroll bar4-8

Contents

4.3	Main menu	4-9
4.3.1	System Date [Day xx/xx/xxxx].....	4-9
4.3.2	System Time [xx:xx:xx]	4-9
4.4	Advanced menu	4-10
4.4.1	Trusted Computing.....	4-10
4.4.2	Chipset Configuration.....	4-10
4.4.3	Platform Configuration	4-17
4.4.4	CPU Configuration	4-26
4.4.5	SATA Configuration	4-29
4.4.6	Network Stack Configuration	4-32
4.4.7	CSM Configuration	4-33
4.4.8	iSCSI Configuration	4-34
4.5	Security Menu.....	4-35
4.6	Boot Menu.....	4-38
4.7	Monitor Menu.....	4-39
4.8	Tool menu.....	4-40
4.9	Save & Exit menu.....	4-40
4.10	Server Mgmt menu.....	4-41
4.11	Event Logs menu	4-45

Chapter 5: RAID Configuration

5.1	Setting up RAID.....	5-2
5.1.1	RAID definitions	5-2
5.1.2	Installing hard disk drives.....	5-3
5.1.3	Setting the RAID mode in BIOS.....	5-3
5.1.4	RAID configuration utilities.....	5-3
5.2	Intel® Rapid Storage Technology enterprise SATA Option ROM Utility.....	5-4
5.2.1	Creating a RAID set.....	5-5
5.2.2	Deleting a RAID set.....	5-7
5.2.3	Resetting disks to Non-RAID	5-8
5.2.4	Exiting the Intel® Rapid Storage Technology enterprise SATA Option ROM utility.....	5-9
5.2.5	Rebuilding the RAID.....	5-9
5.2.6	Setting the Boot array in the BIOS Setup Utility.....	5-11

Contents

5.3	Intel® Rapid Storage Technology enterprise (Windows).....	5-12
5.3.1	Creating a RAID set.....	5-13
5.3.2	Changing a Volume Type.....	5-15
5.3.3	Deleting a volume	5-16
5.3.4	Preferences.....	5-17

Chapter 6: Driver Installation

6.1	RAID driver installation	6-2
6.1.1	Creating a USB flash drive with RAID driver.....	6-2
6.1.2	Installing the RAID controller driver.....	6-2
6.2	Management applications and utilities installation	6-5
6.3	Running the Support DVD	6-5
6.3.1	Drivers menu tab.....	6-6
6.3.2	Utilities menu tab.....	6-6
6.3.3	Manual menu	6-7
6.3.4	Contact information menu.....	6-7
6.4	Installing the Intel® Chipset device Software driver	6-8
6.5	Installing the Intel® I210 Gigabit Adapters driver	6-10
6.6	Installing the VGA driver	6-13

Appendix

P10S-M block diagram.....	A-2
Simplified EU Declaration of Conformity	A-3
ASUS contact information.....	A-4

Notices

Federal Communications Commission Statement

This device complies with Part 15 of the FCC Rules. Operation is subject to the following two conditions:

- This device may not cause harmful interference, and
- This device must accept any interference received including interference that may cause undesired operation.

This equipment has been tested and found to comply with the limits for a Class B digital device, pursuant to Part 15 of the FCC Rules. These limits are designed to provide reasonable protection against harmful interference in a residential installation. This equipment generates, uses and can radiate radio frequency energy and, if not installed and used in accordance with manufacturer's instructions, may cause harmful interference to radio communications. However, there is no guarantee that interference will not occur in a particular installation. If this equipment does cause harmful interference to radio or television reception, which can be determined by turning the equipment off and on, the user is encouraged to try to correct the interference by one or more of the following measures:

- Reorient or relocate the receiving antenna.
- Increase the separation between the equipment and receiver.
- Connect the equipment to an outlet on a circuit different from that to which the receiver is connected.
- Consult the dealer or an experienced radio/TV technician for help.



The use of shielded cables for connection of the monitor to the graphics card is required to assure compliance with FCC regulations. Changes or modifications to this unit not expressly approved by the party responsible for compliance could void the user's authority to operate this equipment.

Compliance Statement of Innovation, Science and Economic Development Canada (ISED)

This device complies with Innovation, Science and Economic Development Canada licence exempt RSS standard(s). Operation is subject to the following two conditions: (1) this device may not cause interference, and (2) this device must accept any interference, including interference that may cause undesired operation of the device.

CAN ICES-3(B)/NMB-3(B)

Déclaration de conformité de Innovation, Sciences et Développement économique Canada (ISED)

Le présent appareil est conforme aux CNR d'Innovation, Sciences et Développement économique Canada applicables aux appareils radio exempts de licence. L'exploitation est autorisée aux deux conditions suivantes : (1) l'appareil ne doit pas produire de brouillage, et (2) l'utilisateur de l'appareil doit accepter tout brouillage radioélectrique subi, même si le brouillage est susceptible d'en compromettre le fonctionnement.

CAN ICES-3(B)/NMB-3(B)

REACH

Complying with the REACH (Registration, Evaluation, Authorization, and Restriction of Chemicals) regulatory framework, we publish the chemical substances in our products at ASUS REACH website at <http://csr.asus.com/english/REACH.htm>.

Australia statement notice

From 1 January 2012 updated warranties apply to all ASUS products, consistent with the Australian Consumer Law. For the latest product warranty details please visit <https://www.asus.com/support>. Our goods come with guarantees that cannot be excluded under the Australian Consumer Law. You are entitled to a replacement or refund for a major failure and compensation for any other reasonably foreseeable loss or damage. You are also entitled to have the goods repaired or replaced if the goods fail to be of acceptable quality and the failure does not amount to a major failure.

If you require assistance please call ASUS Customer Service 1300 2787 88 or visit us at <https://www.asus.com/support>

Safety information

Electrical safety

- To prevent electrical shock hazard, disconnect the power cable from the electrical outlet before relocating the system.
- When adding or removing devices to or from the system, ensure that the power cables for the devices are unplugged before the signal cables are connected. If possible, disconnect all power cables from the existing system before you add a device.
- Before connecting or removing signal cables from the motherboard, ensure that all power cables are unplugged.
- Seek professional assistance before using an adapter or extension cord. These devices could interrupt the grounding circuit.
- Make sure that your power supply is set to the correct voltage in your area. If you are not sure about the voltage of the electrical outlet you are using, contact your local power company.
- If the power supply is broken, do not try to fix it by yourself. Contact a qualified service technician or your retailer.

Operation safety

- Before installing the motherboard and adding devices on it, carefully read all the manuals that came with the package.
- Before using the product, make sure all cables are correctly connected and the power cables are not damaged. If you detect any damage, contact your dealer immediately.
- To avoid short circuits, keep paper clips, screws, and staples away from connectors, slots, sockets and circuitry.
- Avoid dust, humidity, and temperature extremes. Do not place the product in any area where it may become wet.
- Place the product on a stable surface.
- If you encounter technical problems with the product, contact a qualified service technician or your retailer.



DO NOT throw the motherboard in municipal waste. This product has been designed to enable proper reuse of parts and recycling. This symbol of the crossed out wheeled bin indicates that the product (electrical and electronic equipment) should not be placed in municipal waste. Check local regulations for disposal of electronic products.



DO NOT throw the mercury-containing button cell battery in municipal waste. This symbol of the crossed out wheeled bin indicates that the battery should not be placed in municipal waste.

Conventions used in this guide

To ensure that you perform certain tasks properly, take note of the following symbols used throughout this manual.



DANGER/WARNING: Information to prevent injury to yourself when trying to complete a task.



CAUTION: Information to prevent damage to the components when trying to complete a task.



IMPORTANT: Instructions that you **MUST** follow to complete a task.



NOTE: Tips and additional information to help you complete a task.

Typography

Bold text

Indicates a menu or an item to select.

Italics

Used to emphasize a word or a phrase.

<Key>

Keys enclosed in the less-than and greater-than sign means that you must press the enclosed key.

Example: <Enter> means that you must press the Enter or Return key.

<Key1> + <Key2> + <Key3>

If you must press two or more keys simultaneously, the key names are linked with a plus sign (+).

Example: <Ctrl> + <Alt> +

Command

Means that you must type the command exactly as shown, then supply the required item or value enclosed in brackets.

Example: At DOS prompt, type the command line:

format A: /S

P10S-M Specifications Summary

Processor Support / System Bus		1 x Socket LGA1151 Intel® Xeon® processor E3-1200 v5 product family Intel® Core™ i3 processors Intel® Pentium™ processors Intel® Celeron™ processors
Core Logic		Intel® C232 Chipset
Form Factor		Micro ATX, 9.6 in. x 9.6 in.
ASUS Features	Fan Speed Control	✓
	Rack Ready (Rack and Pedestal dual use)	✓
	ASWM Enterprise	✓
Memory	Total Slots	4 (2 Channels)
	Voltage	1.2V
	Capacity	Maximum up to 64GB
	Memory Type	DDR4 2133 ECC/non-ECC UDIMM
	Memory Size	4GB, 8GB, 16GB
Expansion Slots (follow SSI Location number)	Total PCI/PCI-E Slots	4
	Slot Location 1	-
	Slot Location 2	-
	Slot Location 3	-
	Slot Location 4	1 x PCI-E x8 (x4 Gen3 Link)
	Slot Location 5	1 x PCI-E x8 (x4 Gen3 Link)
	Slot Location 6	1 x PCI-E x16 (x8 Gen 3 Link) (Auto switch to x4 if slot 5 is occupied)
	Slot Location 7	1 x PCI-E x8 (x8 Gen3 Link)
Storage	SATA Controller	Intel® C232: - 6 x SATA 6Gb/s ports - Intel® RSTe (Windows & Linux) - Support software RAID 0, 1, 10 & 5
	SAS Controller	Optional Kits: - ASUS PIKE II 3008-8i 8-port SAS 12G RAID card - ASUS PIKE II 3108-8i 8-port SAS 12G HW RAID card

* Refer to www.asus.com for the complete list of supported CPUs.

(continued on the next page)

Networking	LAN	2 x Intel® I210 + 1 x Mgmt LAN
Graphic	VGA	Aspeed AST2400 32MB
Onboard I/O Connectors	TPM Header	1
	PSU Connector	24-pin ATX power connector + 8-pin ATX 12V power connector
	Management Header	Onboard header for optional management card
	USB Connector/ Header	1 x USB 3.0 pin header (up to 2 devices) 1 x USB 2.0 pin header (up to 2 devices) 1 x USB 3.0 connector (Type A USB socket)
	Fan Header	5 x 4 pin headers
	SMBus	1
	Chassis Intruder	1
	Front LAN LED	2
	VGA Header	1
	M.2 Connector	-
Rear I/O Connectors	External Serial Port	1
	External USB Port	2 x USB 3.0 2 x USB 2.0
	VGA Port	1
	RJ-45	2 x GbE LAN + 1 x Mgmt LAN
	PS/2 KB/Mouse	1
Management Solution	Software	ASWM Enterprise
	Out of Band Remote Management	Optional ASMB8-iKVM for KVM-over-Internet
Monitoring	CPU Temperature	✓
	FAN RPM	✓
Environment		Operation temperature: 10°C – 35°C (50°F – 95°F) Non operation temperature: -40°C – 70°C (-40°F – 158°F) Non operation humidity: 20% – 90% (Non condensing)



Specifications are subject to change without notice.

Chapter 1: Product Introduction

1.1 Welcome!

Thank you for buying an ASUS® P10S-M motherboard!

The motherboard delivers a host of new features and latest technologies, making it another standout in the long line of ASUS quality motherboards!

Before you start installing the motherboard and hardware devices on it, check the items in your package with the list below.

1.2 Package contents

Check your motherboard package for the following items.

Items		Standard Gift Box Pack	Standard Bulk Pack
I/O Shield		1	1
Cables	SATA 6G cable	6	--
	COM port cable	1	10 pcs per carton
Application CD	Support DVD	2	2 pc per carton
	ASWM Enterprise SDVD	1	1 pc per carton
Accessory	Metal Plate for LGA1151	1	1
Packaging Qty.		1 pc per carton	10 pcs per carton



If any of the above items is damaged or missing, contact your retailer.

1.3 Serial number label

Before requesting support from the ASUS Technical Support team, you must take note of the motherboard's serial number containing 12 characters **xxS2xxxxxxxx** shown as the figure below. With the correct serial number of the product, ASUS Technical Support team members can then offer a quicker and satisfying solution to your problems.



1.4 Special features

1.4.1 Product highlights

Latest processor technology

This motherboard supports the latest Intel® Xeon® Processor E3-1200 v5/ Core™ i3 series in LGA1151 package, which has memory and PCI Express controller integrated to support 2-channel (4 DIMMs) DDR4 memory and 16 PCI Express 3.0 lanes. The Intel® Xeon® E3-1200 v5 have improve CPU performance and integrated voltage regulators making it one of the most powerful and energy efficient CPU in the world.

Intel® Turbo Boost

Intel® Turbo Boost automatically allows the processor to run faster than the marked frequency if the processor is operating below its power, current, and temperature specification limits. This technology increases performance of both multi-threaded and single-threaded workloads.

Intel® Hyper Threading

The thread-level parallelism on each processor makes more efficient use of the processor resources, higher processing throughput and improved performance on today's multi-threaded software.

Intel® EM64T

The motherboard supports Intel® processors with the Intel® EM64T (Extended Memory 64 Technology). The Intel® EM64T feature allows your computer to run on 64-bit operating systems and access larger amounts of system memory for faster and more efficient computing.

DDR4 memory support

The motherboard supports DDR4 memory that features faster clock frequencies and higher data transfer rates of 2133 MT/s (million transfers per second). DDR4 offers a lower voltage standard of 1.2V that reduces memory power demand and provides improved performance.

PCI Express 3.0

PCI Express 3.0 (PCIe 3.0) is the PCI Express bus standard that provides twice the performance and speed of PCIe 2.0. It provides an optimal graphics performance, unprecedented data speed, and seamless transition with its complete backward compatibility to PCIe 1.0/2.0 devices.

Intel® I210AT LAN Solution

The motherboard comes with two Gigabit LAN controllers and ports which provide a total solution for your networking needs. The onboard Intel® I210AT Gigabit LAN controllers use the PCI Express interface and could achieve network throughput close to Gigabit bandwidth.

Enhanced Intel SpeedStep Technology (EIST)

The Enhanced Intel SpeedStep Technology (EIST) intelligently manages the CPU resources by automatically adjusting the CPU voltage and core frequency depending on the CPU loading and system speed or power requirement.

Serial ATA III technology

The motherboard supports the Serial ATA III 6 Gb/s technology through the Serial ATA interface and Intel® C232 chipset. Get enhanced scalability, faster data retrieval, double the bandwidth of current bus systems with up to 6Gbps data transfer rates.

USB 2.0 technology

The motherboard implements the Universal Serial Bus (USB) 2.0 specification that dramatically increases the connection speed from the 12 Mbps bandwidth on USB 1.1 to a fast 480 Mbps on USB 2.0. USB 2.0 is backward compatible with USB 1.1.

USB 3.0 technology

The motherboard implements the USB 3.0 technology with data transfer speeds of up to 5Gbps, faster charging time for USB-chargeable devices, optimized power efficiency, and backward compatibility with USB 2.0.

Temperature, fan, and voltage monitoring

The CPU temperature is monitored to prevent overheating and damage. The system fan rotations per minute (RPM) is monitored for timely failure detection. The chip monitors the voltage levels to ensure stable supply of current for critical components.

1.4.2 Innovative ASUS features

ASUS Fan Speed technology

The ASUS Fan Speed technology smartly adjusts the fan speeds according to the system loading to ensure quiet, cool, and efficient operation.

Chapter 2: Hardware Information

2.1 Before you proceed

Take note of the following precautions before you install motherboard components or change any motherboard settings.



- Unplug the power cord from the wall socket before touching any component.
 - Use a grounded wrist strap or touch a safely grounded object or a metal object, such as the power supply case, before handling components to avoid damaging them due to static electricity.
 - Hold components by the edges to avoid touching the ICs on them.
 - Whenever you uninstall any component, place it on a grounded antistatic pad or in the bag that came with the component.
 - Before you install or remove any component, ensure that the power supply is switched off or the power cord is detached from the power supply. Failure to do so may cause severe damage to the motherboard, peripherals, and/or components.
-

2.2 Motherboard overview

Before you install the motherboard, study the configuration of your chassis to ensure that the motherboard fits into it.

To optimize the motherboard features, we highly recommend that you install it in an ATX 1.1 compliant chassis.



Ensure to unplug the chassis power cord before installing or removing the motherboard. Failure to do so can cause you physical injury and damage motherboard components!

2.2.1 Placement direction

When installing the motherboard, ensure that you place it into the chassis in the correct orientation. The edge with external ports goes to the rear part of the chassis as indicated in the image below.

2.2.2 Screw holes

Place eight (8) screws into the holes indicated by circles to secure the motherboard to the chassis.



DO NOT overtighten the screws! Doing so can damage the motherboard.

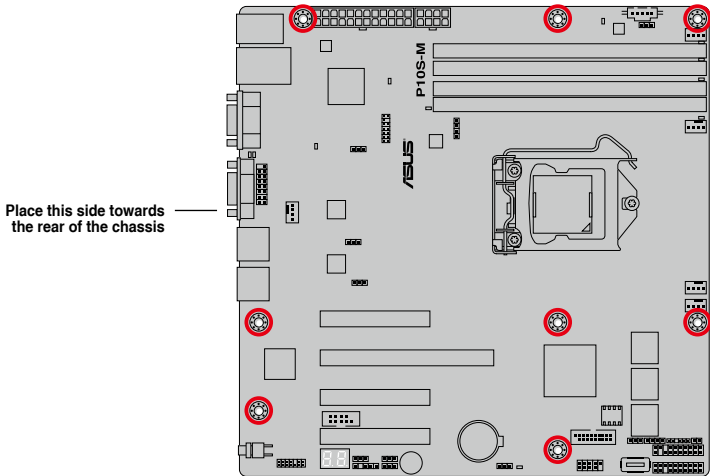

2.2.3 Motherboard layout

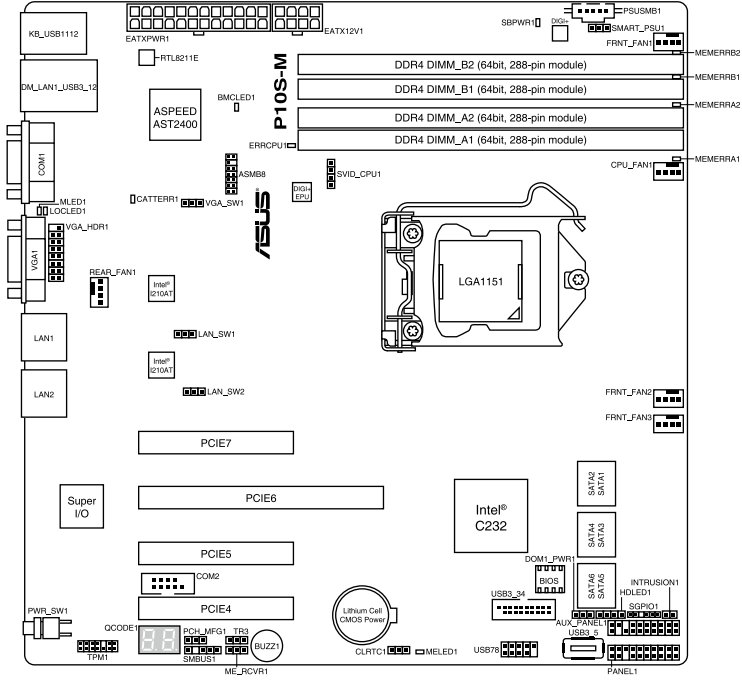

2.2.4 Layout contents

Slots/Sockets		Page
1.	CPU sockets	2-7
2.	DDR4 sockets	2-13
3.	PCI Express x16 / PCI Express x8	2-17

Onboard LEDs		Page
1.	Standby Power LED (SBPWR1)	2-19
2.	Location LED (LOCLED1)	2-19
3.	CATT ERR LED (CATTERR1)	2-20
4.	ME LED (MELED1)	2-20
5.	Message LED (MLED1)	2-20
6.	CPU Warning LED (ERRCPU1)	2-21
7.	Q-Code LEDs (QCODE1)	2-21

Jumpers		Page
1.	Clear RTC RAM (CLRRTC1)	2-25
2.	VGA controller setting (3-pin VGA_SW1)	2-26
3.	LAN controller setting (3-pin LAN_SW1, LAN_SW2)	2-26
4.	ME firmware force recovery setting (3-pin ME_RCVR1)	2-27
5.	PCH_MFG1 setting (3-pin PCH_MFG1)	2-27
6.	Smart Ride Through (Smart) setting (3-pin SMART_PSU1)	2-28

Rear panel connectors		Page
1.	PS/2 keyboard/mouse port	2-29
2.	RJ-45 port for iKVM	2-29
3.	Serial port (COM1)	2-29
4.	Video Graphics Adapter port	2-29
5.	RJ-45 ports for LAN 1-2	2-29
6.	Power-on Button	2-29
7.	USB 2.0 ports 1 and 2	2-29
8.	USB 3.0 ports 1 and 2	2-29

Internal connectors		Page
1.	Serial ATA 6.0 Gbps connector (7-pin SATA 6Gbps 1-6 connector [Light Blue])	2-31
2.	Hard disk activity LED connector (4-pin HDLED1)	2-31
3.	USB 2.0 connector (10-1 pin USB78)	2-32
4.	USB 3.0 connector (20-1 pin USB3_34, A-Type USB3_5)	2-32
5.	CPU, front, and rear fan connectors (4-pin FRNT_FAN1-3, REAR_FAN1, CPU_FAN1)	2-33
6.	Serial General Purpose Input/Output connector (6-1 pin SGPIO1)	2-33
7.	Trusted Platform Module connector (14-1 pin TPM)	2-34
8.	VGA connector (16-1 pin VGA_HDR1))	2-34
9.	Serial port connector (10-1 pin COM2)	2-35
10.	Power Supply SMBus connector (5-pin PSUSMB1)	2-35
11.	ATX power connectors (24-pin EATXPWR1, 8-pin EATX12V1)	2-36
12.	System panel connector (20-1 pin PANEL1)	2-37
13.	Auxiliary panel connector (20-2 pin AUX_PANEL1)	2-38
14.	Chassis intrusion connector (2-pin INTRUSION)	2-39
15.	System Management Bus (SMBUS) connector (5-1 pin SMBUS1)	2-39

2.3 Central Processing Unit (CPU)

The motherboard comes with a surface mount LGA1151 socket designed for the Intel® Xeon® E3-1200 v5 and Intel® Core™ i3 processor.



- Upon purchase of the motherboard, ensure that the PnP cap is on the socket and the socket contacts are not bent. Contact your retailer immediately if the PnP cap is missing, or if you see any damage to the PnP cap/socket contacts/motherboard components. ASUS will shoulder the cost of repair only if the damage is shipment/transit-related.
- The product warranty does not cover damage to the socket contacts resulting from incorrect CPU installation/removal, or misplacement/loss/incorrect removal of the PnP cap.

2.3.1 Installing the CPU

To install the CPU:

1. Locate the CPU socket on the motherboard.

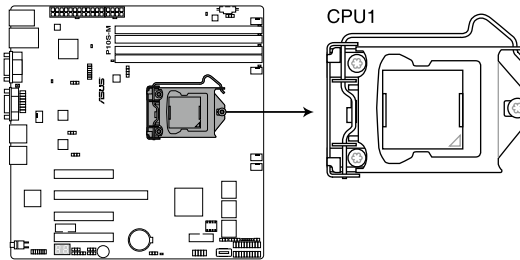

P10S-M CPU LGA1151



Before installing the CPU, ensure that the socket box is facing toward you and the load lever is on your right.

2. Press the load lever with your thumb (A), then move it to the right (B) until it is released from the retention tab.



Do not remove the PnP cap yet from the CPU socket. Doing so may bend the pins of the socket.

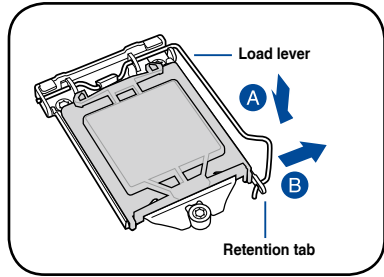

3. Lift the load lever until the load plate is completely lifted.

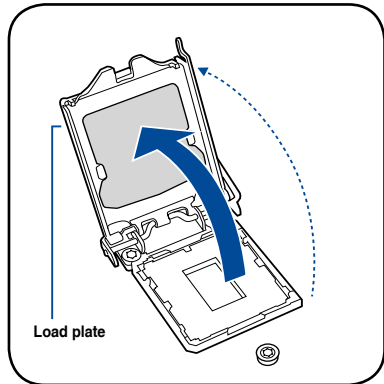

4. Position the CPU above the socket, ensuring that the gold triangle mark is on the bottom-left corner of the socket, then fit the CPU notches to the socket's alignment keys.



The CPU fits in only one orientation. DO NOT force the CPU into the socket to prevent bending the pins on the socket and damaging the CPU.

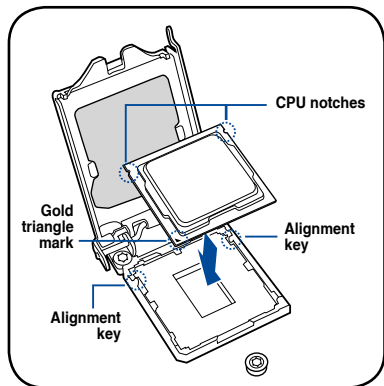

5. Close the load plate (A), ensuring that the front edge of the load plate slides under the retention lock (B) then push down the load lever (C).

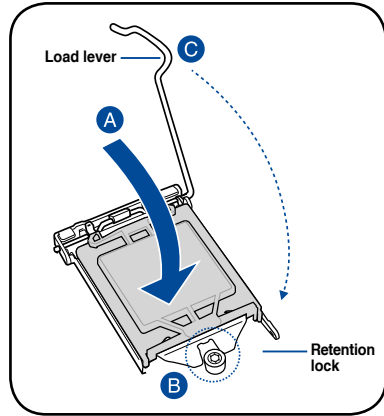

6. Insert the load lever under the retention tab to remove the PnP cap from the CPU socket.

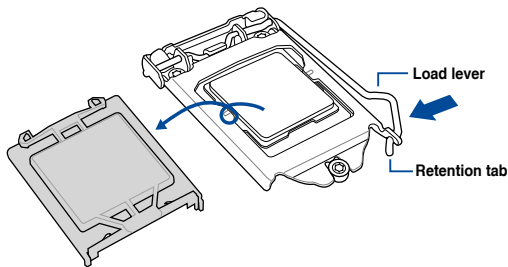

7. Apply some Thermal Interface Material to the exposed area of the CPU that the heatsink will be in contact with, ensuring that it is evenly spread in a thin layer.



Some heatsinks come with pre-applied Thermal Interface Material. If so, skip this step.



The Thermal Interface Material is toxic and inedible. DO NOT eat it. If it gets into your eyes or touches your skin, wash it off immediately and seek professional medical help.

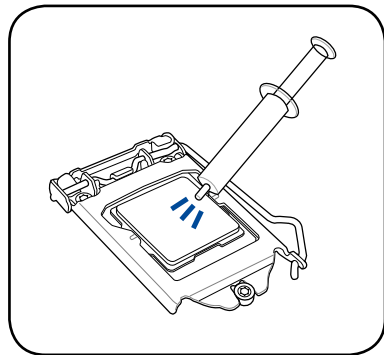

2.3.2 Installing the CPU heatsink

The Intel® LGA1151 processor requires a specially designed CPU heatsink to ensure optimum thermal condition and performance.



- When you buy a boxed Intel® processor, a specially designed CPU heatsink or a CPU heatsink with a CPU fan assembly is included depending on the package. If you buy a CPU separately, ensure that you use only Intel® certified multi-directional CPU heatsink or CPU heatsink with CPU fan.
- Use an LGA1151-compatible CPU heatsink and CPU fan assembly only. The LGA1151 socket is incompatible with the LGA775 and LGA1366 sockets in size and dimension.



If you purchased a separate CPU heatsink and fan assembly, ensure that the Thermal Interface Material is properly applied to the CPU heatsink or CPU before you install the heatsink and fan assembly.



Ensure that you have installed the motherboard to the chassis before you install the CPU fan and heatsink assembly.

To install the CPU heatsink and fan:

1. Place the heatsink on top of the installed CPU, making sure that the four fasteners match the holes on the motherboard.
2. Push down two fasteners at a time in a diagonal sequence to secure the heatsink and fan assembly in place.

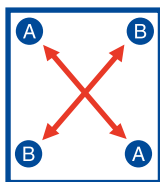
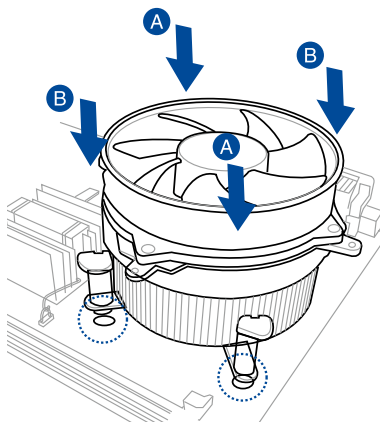

Orient the heatsink and fan assembly such that the CPU fan cable is closest to the CPU fan connector.

3. Connect the CPU fan cable to the connector on the motherboard labeled CPU_FAN1.

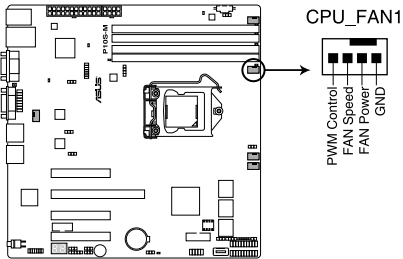

P10S-M Fan connector



DO NOT forget to connect the CPU fan connector! Hardware monitoring errors can occur if you fail to plug this connector.

2.3.3 Uninstalling the CPU heatsink and fan

To uninstall the CPU heatsink and fan:

1. Disconnect the CPU fan cable from the connector on the motherboard.
2. Rotate each fastener counterclockwise.
3. Pull up two fasteners at a time in a diagonal sequence to disengage the heatsink and fan assembly from the motherboard.

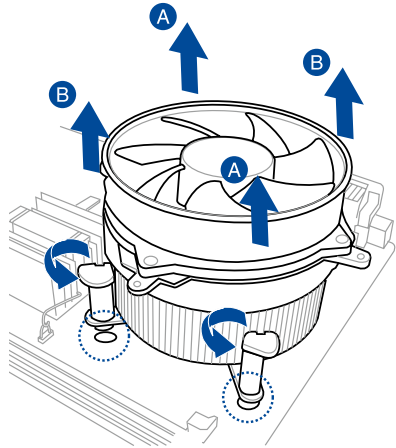
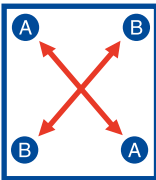

4. Carefully remove the heatsink and fan assembly from the motherboard.

2.3.4 Installing the CPU heatsink in rack

The Intel® LGA1151 processor requires a specially designed heatsink to ensure optimum thermal condition and performance.



- Ensure that you use qualified heatsink assembly only.
- Ensure that you have applied the thermal interface material to the top of the CPU before installing the heatsink and fan.

1. Peel off the sticker on the heatsink metal plate and affix the plate to the back of the motherboard, matching the standoffs to the heatsink screw holes.

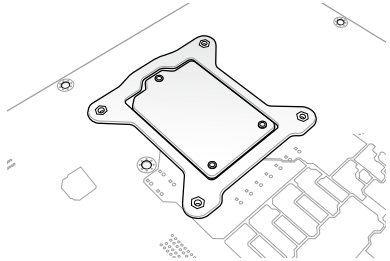

2. Use a Phillips screwdriver to tighten the four heatsink screws using the recommended sequence below.

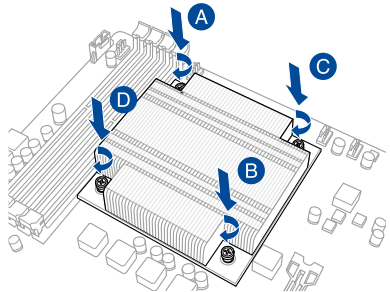
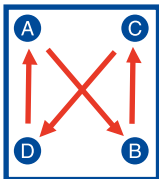

1. Ensure that the heatsink is not skewed or tilted, otherwise the CPU will overheat.
2. Do not overtighten the screws. Doing so can damage the CPU.

2.4 System memory

2.4.1 Overview

The motherboard comes with four (4) Double Data Rate 4 (DDR4) Dual Inline Memory Modules (DIMM) sockets.



A DDR4 module is notched differently from a DDR, DDR2, or DDR3 module. DO NOT install a DDR, DDR2, or DDR3 memory module to the DDR4 slot.

The figure illustrates the location of the DDR4 DIMM sockets:

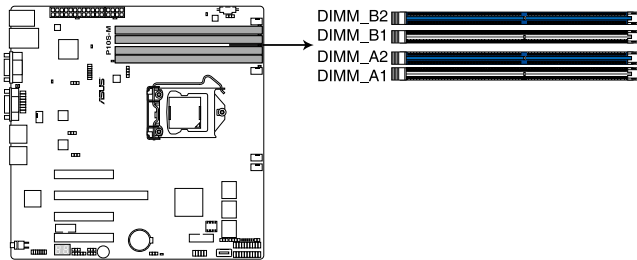

P10S-M 288-pin DDR4 DIMM sockets

2.4.2 Memory configurations

You may install unbuffered DDR4 DIMMs into the DIMM sockets using the memory configurations in this section.

UDIMM				
DIMM Slot Per Channel	DIMM Populated per Channel	DIMM Type	Speed	Rank per DIMM
2	1	Unbuffered DDR4	2133	Single Rank, Dual Rank
2	2	Unbuffered DDR4	2133	Single Rank, Dual Rank



- Always install DIMMs with the same CAS latency. For optimum compatibility, it is recommended that you obtain memory modules from the same vendor.
- Start installing the DIMMs in slots A2 and B2 (Blue).

2.4.3 Installing a DIMM on a single clip DIMM socket

1. Unlock a DIMM socket by pressing the retaining clip outward.
2. Align a DIMM on the socket such that the notch on the DIMM matches the DIMM slot key on the socket.

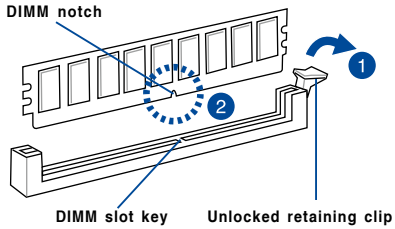

A DIMM is keyed with a notch so that it fits in only one direction. **DO NOT** force a DIMM into a socket in the wrong direction to avoid damaging the DIMM.

3. Hold the DIMM by both of its ends then insert the DIMM vertically into the socket. Apply force to both ends of the DIMM simultaneously until the retaining clip snaps back into place and the DIMM cannot be pushed in any further to ensure proper sitting of the DIMM.

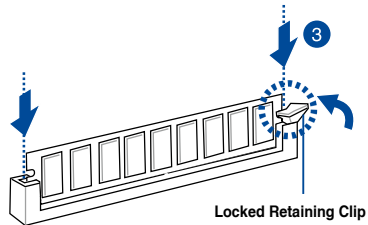

Always insert the DIMM into the socket vertically to prevent DIMM notch damage.



To install two or more DIMMs, refer to the user guide bundled in the motherboard package.

Removing a DIMM from a single clip DIMM socket

1. Press the retaining clip outward to unlock the DIMM.
2. Remove the DIMM from the socket.

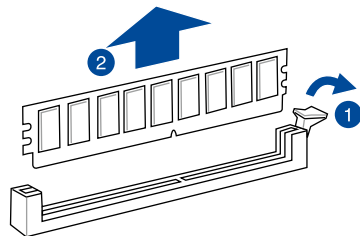

Support the DIMM lightly with your fingers when pressing the retaining clips. The DIMM might get damaged when it flips out with extra force.

2.5 Expansion slots

In the future, you may need to install expansion cards. The following subsections describe the slots and the expansion cards that they support.



Ensure to unplug the power cord before adding or removing expansion cards. Failure to do so may cause you physical injury and damage motherboard components.

2.5.1 Installing an expansion card

To install an expansion card:

1. Before installing the expansion card, read the documentation that came with it and make the necessary hardware settings for the card.
2. Remove the system unit cover (if your motherboard is already installed in a chassis).
3. Remove the bracket opposite the slot that you intend to use. Keep the screw for later use.
4. Align the card connector with the slot and press firmly until the card is completely seated on the slot.
5. Secure the card to the chassis with the screw you removed earlier.
6. Replace the system cover.

2.5.2 Configuring an expansion card

After installing the expansion card, configure it by adjusting the software settings.

1. Turn on the system and change the necessary BIOS settings, if any. See Chapter 4 for information on BIOS setup.
2. Assign an IRQ to the card. Refer to the tables on the next page.
3. Install the software drivers for the expansion card.



When using PCI cards on shared slots, ensure that the drivers support “Share IRQ” or that the cards do not need IRQ assignments. Otherwise, conflicts will arise between the two PCI groups, making the system unstable and the card inoperable.

2.5.3 Interrupt assignments

Standard Interrupt assignments

IRQ	Priority	Standard function
0	1	System Timer
1	2	Keyboard Controller
2	-	Programmable Interrupt
3*	-	--
4*	9	Communications Port (COM1)
5*	10	Print Port (LPT1)
6	-	--
7*	-	--
8	3	System CMOS/Real Time Clock
9*	4	ACPI Mode when used
10*	5	IRQ Holder for PCI Steering
11*	6	IRQ Holder for PCI Steering
12*	7	PS/2 Compatible Mouse Port
13	8	Numeric Data Processor
14*	-	--
15*	-	--

* These IRQs are usually available for ISA or PCI devices.

2.5.4 PCI Express x8 slot (x8 link)

The onboard PCIE 7 provides one x8 Gen3 links to the CPU. This slot supports various server class high performance add-on cards.

2.5.5 PCI Express x16 slot (x8 link)

The onboard PCIE 6 provides one x8 Gen3 link to the CPU, and auto switches to x4 link if PCIE 5 is occupied. This slot supports various server class high performance add-on cards.

2.5.6 PCI Express x8 slot (x4 link)

The onboard PCIE 5 provides one x4 Gen3 links to the CPU. This slot supports various server class high performance add-on cards.

2.5.7 PCI Express x8 slot (x4 link)

The onboard PCIE 4 provides one x8 Gen3 links to the PCH. This slot supports various server class high performance add-on cards.

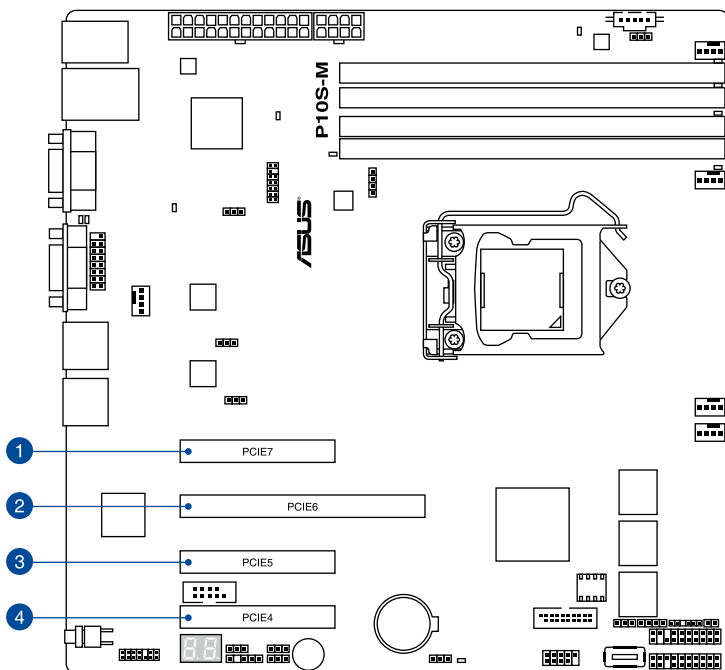

No.(Slot location)	Short Description	
1 (slot 7)	PCIE7	1 x PCI-E x8 (x8 Gen3 Link)
2 (slot 6)	PCIE6	1 x PCI-E x16 (x8 Gen3 link) (Auto switch to x4 if slot 5 is occupied)
3 (slot 5)	PCIE5	1 x PCI-E x8 (x4 Gen3 Link)
4 (slot 4)	PCIE4	1 x PCI-E x8 (x4 Gen3 Link)

2.5.8 Installing the Baseboard Management Card

Follow the steps below to install an optional ASMB8 Management Card on your motherboard.

1. Locate the Baseboard Management Card header on the motherboard.

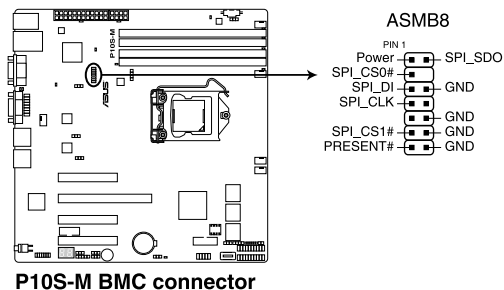

2. Orient and press the Management Card in place.

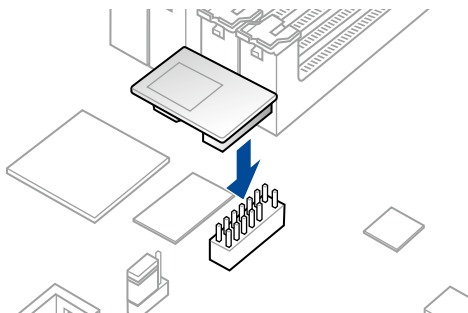

The motherboard illustration is for reference only. The motherboard layout and appearance may vary depending on the model, but the installation steps remain the same.

2.6 Onboard LEDs

1. Standby Power LED (SBPWR1)

The motherboard comes with a standby power LED. The green LED lights up to indicate that the system is ON, in sleep mode, or in soft-off mode. This is a reminder that you should shut down the system and unplug the power cable before removing or plugging in any motherboard component. The illustration below shows the location of the onboard LED.

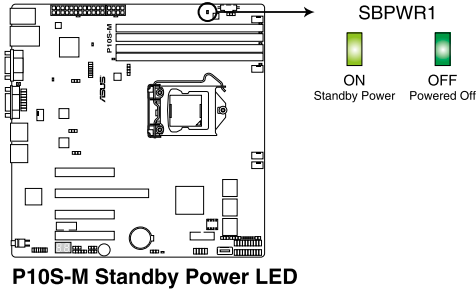

2. Location LED (LOCLED1)

The Location LED is an onboard LED that lights up when the Location Button on the front panel is pressed. This LED helps you visually locate the server among other servers especially when you are located at the back of the server rack.

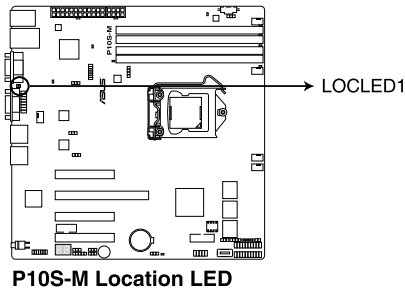

3. CATT ERR LED (CATTERR1)

The CATT ERR LED indicates that the system has experienced a fatal or catastrophic error and cannot continue to operate.

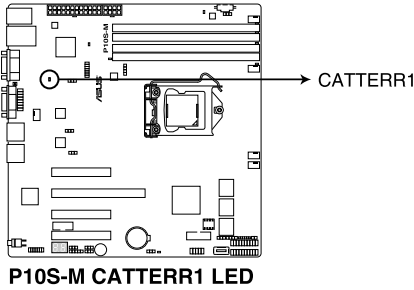

4. ME LED (MELED1)

The ME LED is an onboard LED that blinks when the the ME is operating properly.

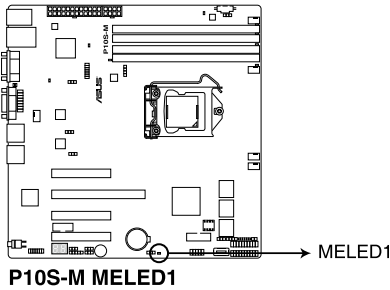

5. Message LED (MLED1)

This onboard LED lights up to red when there is temperature warning or a BMC event log is generated.

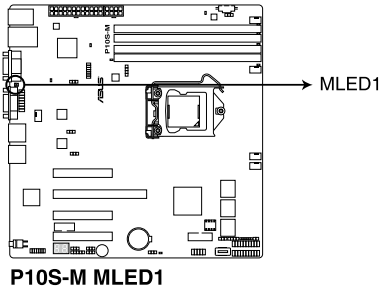

6. CPU Warning LED (ERRCPU1)

The CPU warning LED lights up to indicate that a CPU error or failure has occurred.

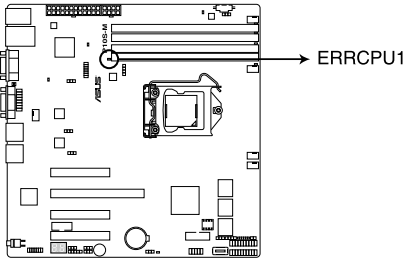

P10S-M ERRCPU1

7. Q-Code LEDs (QCODE1)

The Q-Code LED design provides you with a 2-digit error code that displays the system status. Refer to the Q-Code table on the next page for details.

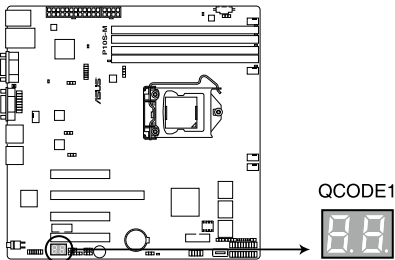

P10S-M Q-Code LED

Q-Code table

Code	Description
00	Not used
02	microcode
03	CACHE_ENABLED
04	PCH initialization
06	CPU_EARLY_INIT
10	PEI Core is started
11 – 14	Pre-memory CPU initialization is started
15 – 18	Pre-memory System Agent initialization is started
19 – 1C	Pre-memory PCH initialization is started
2B – 2F	Memory initialization
30	Reserved for ASL (see ASL Status Codes section below)
31	Memory Installed
32 – 36	CPU post-memory initialization
37 – 3A	Post-Memory System Agent initialization is started
3B – 3E	Post-Memory PCH initialization is started
4F	DXE IPL is started
50 – 53	Memory initialization error. Invalid memory type or incompatible memory speed
4F	DXE IPL is started
54	Unspecified memory initialization error
55	Memory not installed
56	Invalid CPU type or Speed
57	CPU mismatch
58	CPU self test failed or possible CPU cache error
59	CPU micro-code is not found or micro-code update is failed
5A	Internal CPU error
5B	Reset PPI is not available
5C – 5F	Reserved for future AMI error codes
E0	S3 Resume is started (S3 Resume PPI is called by the DXE IPL)
E1	S3 Boot Script execution
E2	Video repost
E3	OS S3 wake vector call
E4 – E7	Reserved for future AMI progress codes
E8	S3 Resume Failed
E9	S3 Resume PPI not Found
EA	S3 Resume Boot Script Error
EB	S3 OS Wake Error
EC – EF	Reserved for future AMI error codes
F0	Recovery condition triggered by firmware (Auto recovery)
F1	Recovery condition triggered by user (Forced recovery)
F2	Recovery process started
F3	Recovery firmware image is found
F4	Recovery firmware image is loaded
F5 – F7	Reserved for future AMI progress codes
F8	Recovery PPI is not available

(continued on the next page)

Code	Description
F9	Recovery capsule is not found
FA	Invalid recovery capsule
FB – FF	Reserved for future AMI error codes
60	DXE Core is started
61	NVRAM initialization
62	Installation of the PCH Runtime Services
63 – 67	CPU DXE initialization is started
68	PCI host bridge initialization
69	System Agent DXE initialization is started
6A	System Agent DXE SMM initialization is started
6B – 6F	System Agent DXE initialization (System Agent module specific)
70	PCH DXE initialization is started
71	PCH DXE SMM initialization is started
72	PCH devices initialization
73 – 77	PCH DXE Initialization (PCH module specific)
78	ACPI module initialization
79	CSM initialization
7A – 7F	Reserved for future AMI DXE codes
90	Boot Device Selection (BDS) phase is started
91	Driver connecting is started
92	PCI Bus initialization is started
93	PCI Bus Hot Plug Controller Initialization
94	PCI Bus Enumeration
95	PCI Bus Request Resources
96	PCI Bus Assign Resources
97	Console Output devices connect
98	Console input devices connect
99	Super IO Initialization
9A	USB initialization is started
9B	USB Reset
9C	USB Detect
9D	USB Enable
9E – 9F	Reserved for future AMI codes
A0	IDE initialization is started
A1	IDE Reset
A2	IDE Detect
A3	IDE Enable
A4	SCSI initialization is started
A5	SCSI Reset
A6	SCSI Detect
A7	SCSI Enable
A8	Setup Verifying Password

(continued on the next page)

Code	Description
A9	Start of Setup
AA	Reserved for ASL (see ASL Status Codes section below)
AB	Setup Input Wait
AC	Reserved for ASL (see ASL Status Codes section below)
AD	Ready To Boot event
AE	Legacy Boot event
AF	Exit Boot Services event
B0	Runtime Set Virtual Address MAP Begin
B1	Runtime Set Virtual Address MAP End
B2	Legacy Option ROM Initialization
B3	System Reset
B4	USB hot plug
B5	PCI bus hot plug
B6	Clean-up of NVRAM
B7	Configuration Reset (reset of NVRAM settings)
B8– BF	Reserved for future AMI codes
D0	CPU initialization error
D1	System Agent initialization error
D2	PCH initialization error
D3	Some of the Architectural Protocols are not available
D4	PCI resource allocation error. Out of Resources
D5	No Space for Legacy Option ROM
D6	No Console Output Devices are found
D7	No Console Input Devices are found
D8	Invalid password
D9	Error loading Boot Option (LoadImage returned error)
DA	Boot Option is failed (StartImage returned error)
DB	Flash update is failed
DC	Reset protocol is not available

ACPI/ASL Checkpoints (under OS)

Code	Description
03	System is entering S3 sleep state
04	System is entering S4 sleep state
05	System is entering S5 sleep state
30	System is waking up from the S3 sleep state
40	System is waking up from the S4 sleep state
AC	System has transitioned into ACPI mode. Interrupt controller is in PIC mode.
AA	System has transitioned into ACPI mode. Interrupt controller is in APIC mode.

2.7 Jumpers

1. Clear RTC RAM (3-pin CLRTC1)

This jumper allows you to clear the CMOS memory system setup parameters by erasing the CMOS Real Time Clock (RTC) RAM data. The onboard button cell battery powers the RAM data in CMOS, which include system setup information such as system passwords.

To erase the RTC RAM:

1. Turn OFF the computer and unplug the power cord.
2. Move the jumper cap from pins 1–2 (default) to pins 2–3. Keep the cap on pins 2–3 for about 5–10 seconds, then move the cap back to pins 1–2.
3. Plug the power cord and turn ON the computer.
4. Hold down the key during the boot process and enter BIOS setup to re-enter data.



Except when clearing the RTC RAM, never remove the cap on CLRTC jumper default position. Removing the cap will cause system boot failure!



If the steps above do not help, remove the onboard battery and move the jumper again to clear the CMOS RTC RAM data. After the CMOS clearance, reinstall the battery.

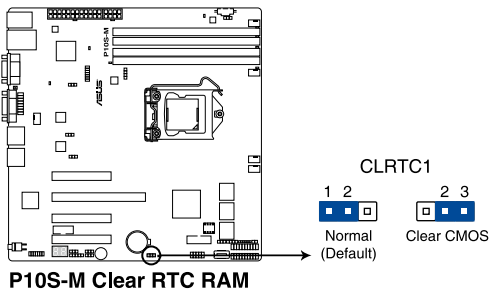

2. VGA controller setting (3-pin VGA_SW1)

This jumper allows you to enable or disable the onboard VGA controller. Set to pins 1–2 to activate the VGA feature.

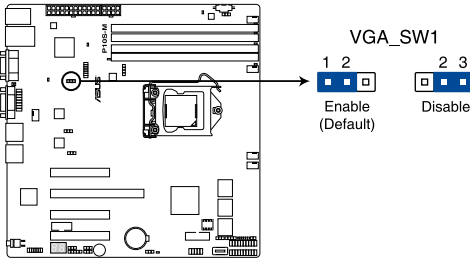

P10S-M VGA setting

3. LAN controller setting (3-pin LAN_SW1, LAN_SW2)

These jumpers allow you to enable or disable the onboard Intel® I210 Gigabit LAN controllers. Set to pins 1-2 to activate the Gigabit LAN feature.

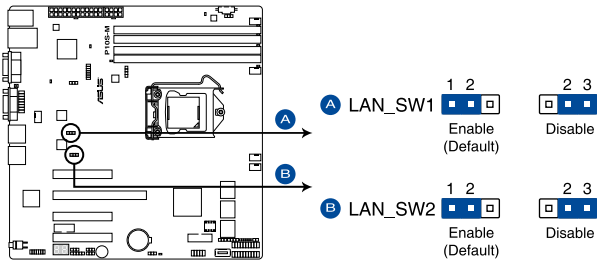

P10S-M LAN setting

4. ME firmware force recovery setting (3-pin ME_RCVR1)

This jumper allows you to force Intel Management Engine (ME) boot from recovery mode when ME become corrupted.

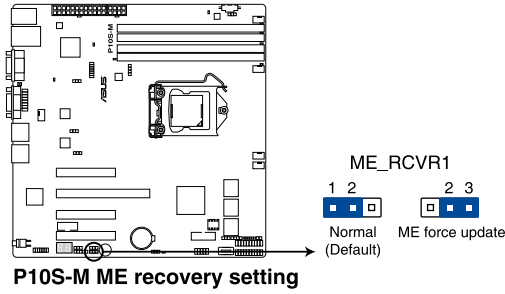

5. PCH_MFG1 setting (3-pin PCH_MFG1)

This jumper allows you to update the BIOS ME block.

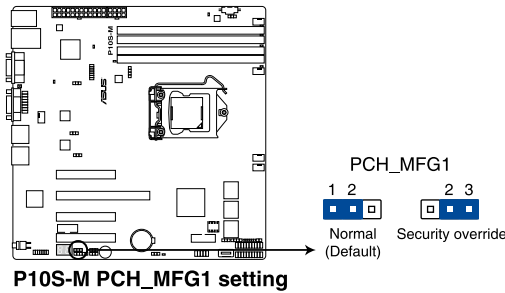

6. Smart Ride Through (SMART) setting (3-pin SMART_PSU1)

This jumper allows you to enable or disable the Smart Ride Through (SmaRT) function. This feature is disabled by default. Set to pins 1-2 to enable it. When enabled, SmaRT allows uninterrupted operation of the system during an AC loss event.

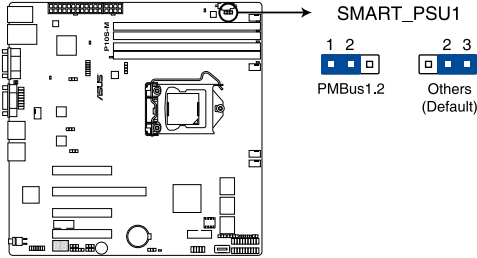

P10S-M PMBus 1.2 PSU setting

2.8 Connectors

2.8.1 Rear panel connectors

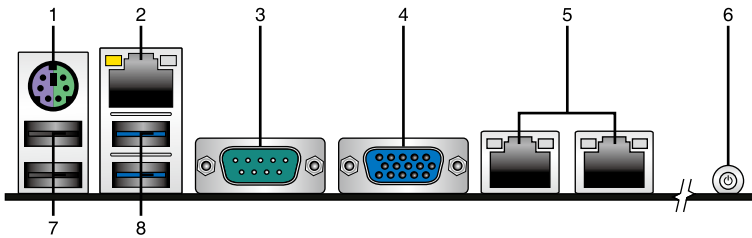

1. **PS/2 keyboard/mouse port (purple/green).** This port is for a PS/2 keyboard or mouse.
2. **RJ-45 port for iKVM.** This RJ-45 port functions only when you enable ASMB8 Management card.
3. **Serial port (COM1).** This 9-pin communication port is for pointing devices. It is also used for serial interface for data transfer.
4. **Video Graphics Adapter port.** This port is for a VGA monitor or other VGA-compatible devices.
5. **RJ-45 ports for LAN 1-2.** These ports allows Gigabit connection to a Local Area Network (LAN) through a network hub. Refer to the table below for the LAN port LED indications.
6. **Power-on Button.** Press this button to turn on the system.
7. **USB 2.0 ports 1 and 2.** These two 4-pin Universal Serial Bus (USB) ports are available for connecting USB 2.0 devices.
8. **USB 3.0 ports 1 and 2.** These two 4-pin USB ports are available for connecting USB 3.0 devices.

LAN port LED indications

Activity/Link LED		Speed LED	
Status	Description	Status	Description
OFF	No link	OFF	10 Mbps connection
ORANGE	Linked	ORANGE	100 Mbps connection
BLINKING	Data activity	GREEN	1 Gbps connection

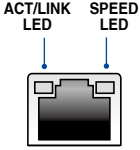

Dedicated Management LAN port (DM_LAN1) LED indications

Activity/Link LED		Speed LED	
Status	Description	Status	Description
OFF	No link	OFF	10 Mbps connection
ORANGE	Linked	ORANGE	100 Mbps connection
BLINKING	Data activity	GREEN	1 Gbps connection

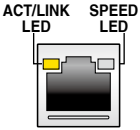

2.8.2 Internal connectors

1. Serial ATA 6.0 Gbps connectors (7-pin SATA 6Gbps_1-6 connectors [Light Blue])

Supported by the Intel® C232 chipset, these connectors are for the Serial ATA signal cables for Serial ATA hard disk drives that allows up to 6Gb/s of data transfer rate.

If you installed Serial ATA hard disk drives, you can create a RAID 0, RAID 1, RAID 10, or RAID 5 configuration.

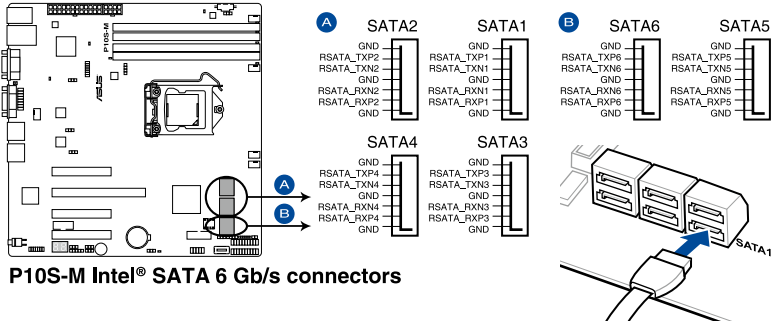

The actual data transfer rate depends on the speed of Serial ATA hard disks installed.

2. Hard disk activity LED connector (4-pin HDLED1)

This LED connector is for the storage add-on card cable connected to the SATA or SAS add-on card. The read or write activities of any device connected to the SATA or SAS add-on card causes the front panel LED to light up.

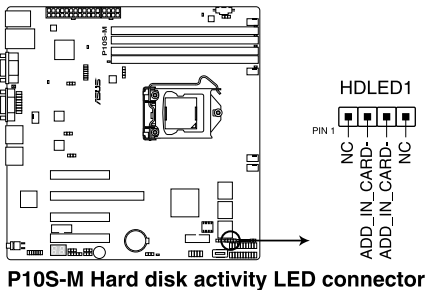

3. USB 2.0 connector (10-1 pin USB78)

This connector is for USB 2.0 ports. Connect the USB module cable to this connector. This USB connector complies with USB 2.0 specification that supports up to 480 Mbps connection speed.

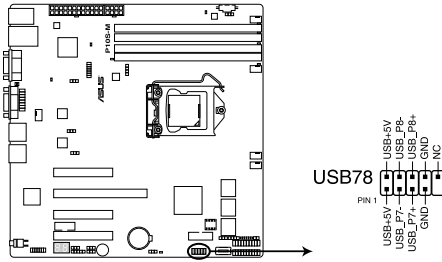

P10S-M USB2.0 connector

4. USB 3.0 connector (20-1 pin USB3_34, A-Type USB3_5)

These connectors allow you to connect a USB 3.0 module for additional USB 3.0 front or rear panel ports. With an installed USB 3.0 module, you can enjoy all the benefits of USB 3.0 including faster data transfer speeds of up to 5Gbps, faster charging time for USB-chargeable devices, optimized power efficiency, and backward compatibility with USB 2.0.

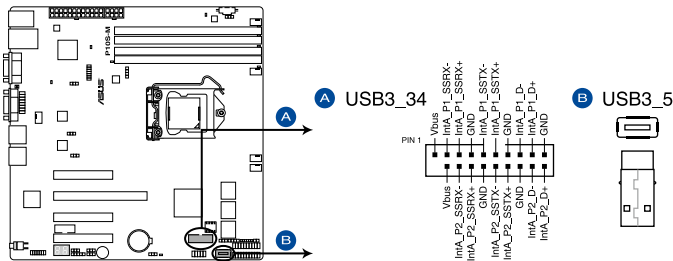

P10S-M USB3.0 connectors

5. CPU, front, and rear fan connectors (4-pin FRNT_FAN1-3, REAR_FAN1, CPU_FAN1)

The fan connectors support cooling fans. Connect the fan cables to the fan connectors on the motherboard, ensuring that the black wire of each cable matches the ground pin of the connector.



- DO NOT forget to connect the fan cables to the fan connectors. Insufficient air flow inside the system may damage the motherboard components.
- These are not jumpers! DO NOT place jumper caps on the fan connectors!
- All fans feature the ASUS Smart Fan technology.

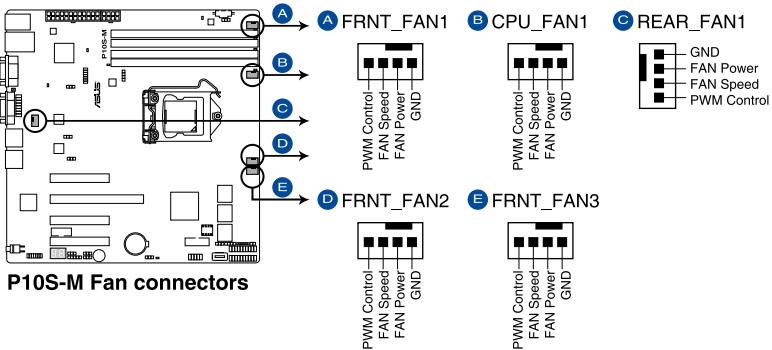

6. Serial General Purpose Input/Output connector (6-1 pin SGPIO1)

The SGPIO 1 connector is used for the Intel Rapid Storage Technology Enterprise SGPIO interface that controls the LED pattern generation, device information, and general purpose data.

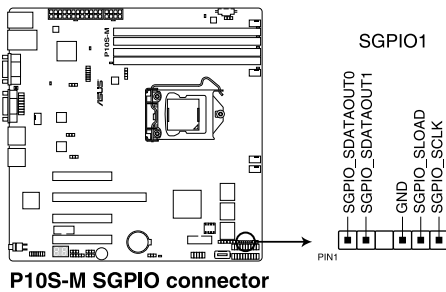

7. Trusted Platform Module connector (14-1 pin TPM)

This connector supports a Trusted Platform Module (TPM) system, which can securely store keys, digital certificates, passwords, and data. A TPM system also helps enhance network security, protects digital identities, and ensures platform integrity.

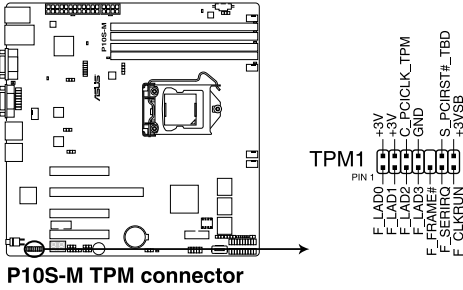

8. VGA connector (16-1 pin VGA_HDR1)

This connector supports the VGA High Dynamic-Range interface.

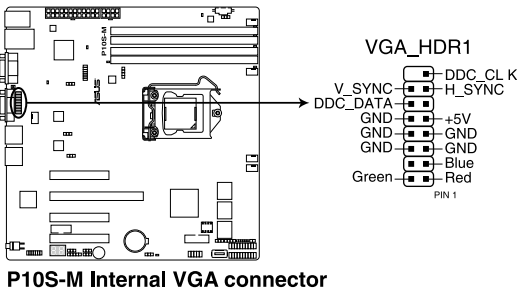

9. Serial port connector (10-1 pin COM2)

This connector is for the serial (COM) port. Connect the serial port module cable to the connector, then install the module to a slot opening at the back of the system chassis.

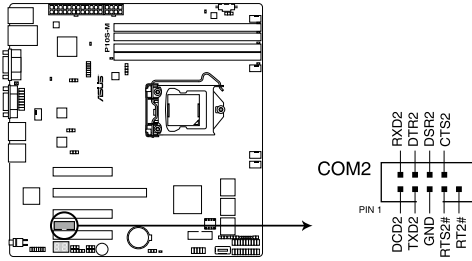

P10S-M Serial port connector

10. Power Supply SMBus connector (5-pin PSUSMB1)

This connector allows you to connect SMBus (System Management Bus) to the PSU (power supply unit) to read PSU information. Devices communicate with an SMBus host and/or other SMBus devices using the SMBus interface.

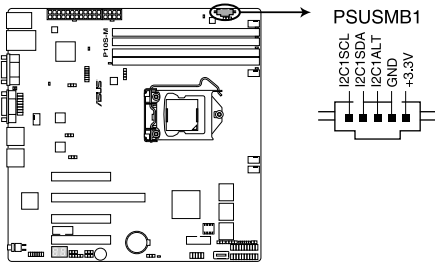

P10S-M Power supply SMBus connector



This connector functions only when you enable the ASUS ASMB8.



Power supply is required to meet PMBus specification and customized BMC FW may be needed. Please contact ASUS if you need further support.

11. ATX power connectors (24-pin EATXPWR1, 8-pin EATX12V1)

These connectors are for the ATX power supply plugs. The power supply plugs are designed to fit these connectors in only one orientation. Find the proper orientation and push down firmly until the connectors completely fit.



- DO NOT forget to connect the 24-pin and the 8-pin power plugs; otherwise, the system will not boot up.
- Use of a power supply unit (PSU) with a higher power output is recommended when configuring a system with more power-consuming devices. The system may become unstable or may not boot up if the power is inadequate.
- This motherboard supports ATX2.0 PSU or later version.
- Ensure that your PSU can provide at least the minimum power required by your system.

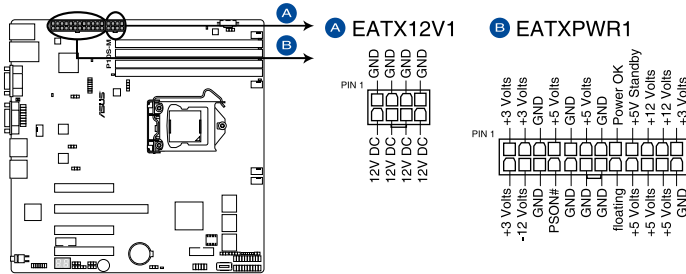

P10S-M ATX power connectors

12. System panel connector (20-1 pin PANEL1)

This connector supports several chassis-mounted functions.

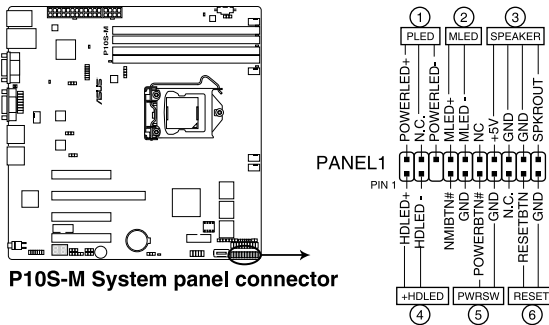

1. System power LED (3-pin PLED)

This 3-pin connector is for the system power LED. Connect the chassis power LED cable to this connector. The system power LED lights up when you turn on the system power, and blinks when the system is in sleep mode.

2. Message LED (2-pin MLED)

This 2-pin connector is for the message LED cable that connects to the front message LED. The message LED is controlled by Hardware monitor to indicate an abnormal event occurrence.

3. System warning speaker (4-pin SPEAKER)

This 4-pin connector is for the chassis-mounted system warning speaker. The speaker allows you to hear system beeps and warnings.

4. Hard disk drive activity LED (2-pin +HLED)

This 2-pin connector is for the HDD Activity LED. Connect the HDD Activity LED cable to this connector. The IDE LED lights up or flashes when data is read from or written to the HDD.

5. Power button/soft-off button (2-pin PWRSW)

This connector is for the system power button. Pressing the power button turns the system on or puts the system in sleep or soft-off mode depending on the BIOS settings. Pressing the power switch for more than four (4) seconds while the system is ON turns the system OFF.

6. Reset button (2-pin RESET)

This 2-pin connector is for the chassis-mounted reset button for system reboot without turning off the system power.

13. Auxiliary panel connector (20-2 pin AUX_PANEL1)

This connector is for additional front panel features including front panel SMB, locator LED and switch, and LAN LEDs.

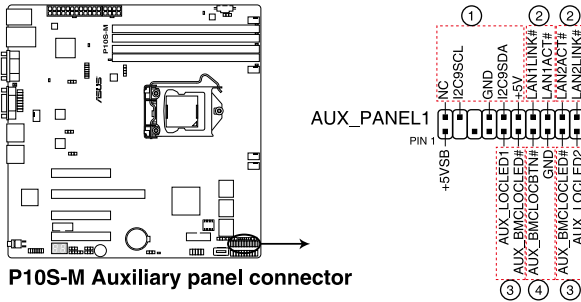

P10S-M Auxiliary panel connector

1. Front panel SMB (6-1 pin FPSMB)

These connectors connect the front panel SMBus cable.

2. LAN activity LED (2-pin LAN1LINK and 2-pin LAN2LINK)

These connectors are for Gigabit LAN activity LEDs on the front panel.

3. Locator LED (2-pin AUX_LOCLEDD1 and 2-pin AUX_LOCLEDD2)

These connectors are for the Locator LED1 and LED2 on the front panel. Connect the Locator LED cables to these 2-pin connectors. The LEDs will light up when the Locator button is pressed.

4. Locator Button/Switch (2-pin AUX_BMCLOCBNT)

These connectors are for the locator button on the front panel. This button queries the state of the system locator.

14. Chassis intrusion connector (2-pin INTRUSION)

This connector is for a chassis-mounted intrusion detection sensor or switch. Connect one end of the chassis intrusion sensor or switch cable to this connector. The chassis intrusion sensor or switch sends a high-level signal to this connector when a chassis component is removed or replaced. The signal is then generated as a chassis intrusion event.

By default, the pin labeled “Chassis Signal” and “Ground” are shorted with a jumper cap. Remove the jumper caps only when you intend to use the chassis intrusion detection feature.

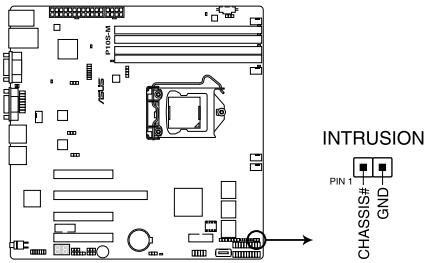

P10S-M Chassis Intrusion connector

15. System Management Bus (SMBUS) connector (5-1 pin SMBUS1)

This connector controls the system and power management-related tasks. This connector processes the messages to and from devices rather than tripping the individual control lines.

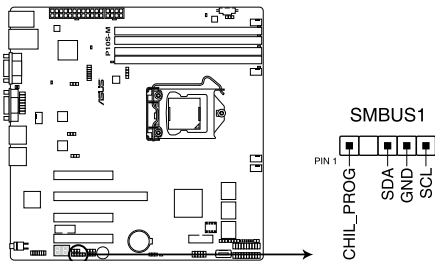

P10S-M SMBUS connector

Chapter 3: Powering Up

3.1 Starting up for the first time

1. After making all the connections, replace the system case cover.
2. Be sure that all switches are off.
3. Connect the power cord to the power connector at the back of the system chassis.
4. Connect the power cord to a power outlet that is equipped with a surge protector.
5. Turn on the devices in the following order:
 - a. Monitor
 - b. External storage devices (starting with the last device on the chain)
 - c. System power
6. After applying power, the system power LED on the system front panel case lights up. For systems with ATX power supplies, the system LED lights up when you press the ATX power button. If your monitor complies with “green” standards or if it has a “power standby” feature, the monitor LED may light up or switch between orange and green after the system LED turns on.

The system then runs the power-on self-test or POST. While the tests are running, the BIOS beeps or additional messages appear on the screen. If you do not see anything within 30 seconds from the time you turned on the power, the system may have failed a power-on test. Check the jumper settings and connections or call your retailer for assistance.

The following shows the possible beep codes and its corresponding error condition

BIOS Beep codes	
Beep	Error condition
1 short	Power supply surges detected during the previous power on.
1 short	No Keyboard Detected.
1 short, 2 short	No DIMM Detected.
1 short, 8 short	No VGA Detected.
2 long	Chassis Intrusion.
2 long	BIOS-image Crash Detected.

7. At power on, hold down the key to enter the BIOS Setup. Follow the instructions in Chapter 4.

3.2 Powering off the computer

3.2.1 Using the OS shut down function

Using Windows® Server 2008 R2:

1. Click the **Start** button, move the cursor to the triangle on the right of Log off, then click **Shut Down**.
2. From the **Shutdown Event Tracker**, select the option that best describes why you want to shut down the computer.
3. Ensure that the **Planned** check box is checked.
4. If necessary, key in comments.
5. Click **OK**.

Using Windows® Server 2012:

1. Press <Ctrl>+<Alt>+.
2. Click on the Power icon on the lower right side of the screen.
3. Select **Shut down**.
4. In the Shutdown Event Tracker, select the **Other (Planned)** option in the selection lists. Otherwise, select the option that best describes why you want to shut down the computer.
5. Click **Continue**.

3.2.2 Using the dual function power switch

While the system is ON, press the power switch for less than four seconds to put the system to sleep mode or to soft-off mode, depending on the BIOS setting.



Pressing the power switch for more than four seconds lets the system enter the soft-off mode regardless of the BIOS setting.

Chapter 4: BIOS Setup

4.1 Managing and updating your BIOS

The following utilities allow you to manage and update the motherboard Basic Input/Output System (BIOS) setup:

1. **ASUS CrashFree BIOS 3**

To recover the BIOS using a bootable USB flash disk drive when the BIOS file fails or gets corrupted.

2. **ASUS EzFlash**

Updates the BIOS using a USB flash disk.

3. **BUPDATER**

Updates the BIOS in DOS mode using a bootable USB flash disk drive.

Refer to the corresponding sections for details on these utilities.



Save a copy of the original motherboard BIOS file to a bootable USB flash disk drive in case you need to restore the BIOS in the future. Copy the original motherboard BIOS using the BUPDATER utility.

4.1.1 ASUS CrashFree BIOS 3 utility

The ASUS CrashFree BIOS 3 is an auto recovery tool that allows you to restore the BIOS file when it fails or gets corrupted during the updating process. You can update a corrupted BIOS file using a USB flash drive that contains the updated BIOS file.



Prepare a USB flash drive containing the updated motherboard BIOS before using this utility.



When downloading or updating the BIOS file, rename it as **P10SM.CAP** for this motherboard.

Recovering the BIOS from a USB flash drive

To recover the BIOS from a USB flash drive:

1. Insert the USB flash drive with the original or updated BIOS file to one USB port on the system.
2. The utility will automatically recover the BIOS. It resets the system when the BIOS recovery finished.



DO NOT shut down or reset the system while recovering the BIOS! Doing so would cause system boot failure!



The recovered BIOS may not be the latest BIOS version for this motherboard. Visit the ASUS website at www.asus.com to download the latest BIOS file.

4.1.2 ASUS EzFlash Utility

The ASUS EzFlash Utility feature allows you to update the BIOS using a USB flash disk without having to use a DOS-based utility.



Download the latest BIOS from the ASUS website at www.asus.com before using this utility.



The succeeding BIOS screens are for reference only. The actual BIOS screen displays may not be the same as shown.

To update the BIOS using EzFlash Utility:

1. Insert the USB flash disk that contains the latest BIOS file to the USB port.
2. Enter the BIOS setup program. Go to the **Tool** menu to select **Start EzFlash** and press <Enter> to enable it.

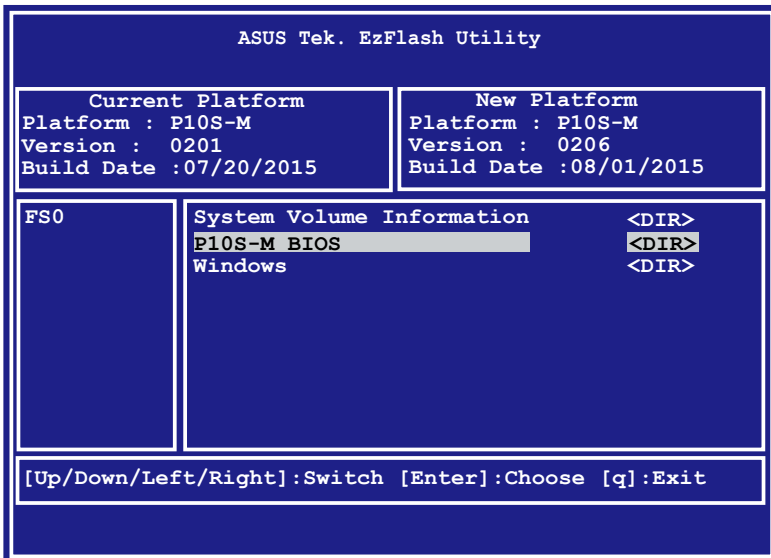

3. Press <Tab> to switch to the **Drive** field.
4. Press the Up/Down arrow keys to find the USB flash disk that contains the latest BIOS then press <Enter>.
5. Press <Tab> to switch to the **Folder Info** field.
6. Press the Up/Down arrow keys to find the BIOS file then press <Enter>.
7. Reboot the system when the update process is done.



-
- This function can support devices such as a USB flash disk with FAT 32/16 format and single partition only.
 - DO NOT shut down or reset the system while updating the BIOS to prevent system boot failure!
-



Ensure to load the BIOS default settings to ensure system compatibility and stability. Press <F5> and select **Yes** to load the BIOS default settings.

4.1.3 BUPDATER utility



The succeeding BIOS screens are for reference only. The actual BIOS screen displays may not be the same as shown.

The BUPDATER utility allows you to update the BIOS file in DOS environment using a bootable USB flash disk drive with the updated BIOS file.

Updating the BIOS file

To update the BIOS file using the BUPDATER utility:

1. Visit the ASUS website at www.asus.com and download the latest BIOS file for the motherboard. Save the BIOS file to a bootable USB flash disk drive.
2. Download the BUPDATER utility (BUPDATER.exe) from the ASUS support website at www.asus.com/support to the bootable USB flash disk drive you created earlier.
3. Boot the system in DOS mode, then at the prompt, type:

```
BUPDATER /i [filename] .CAP
```

where [filename] is the latest or the original BIOS file on the bootable USB flash disk drive, then press <Enter>.

```
A:\>BUPDATER /i[file name]CAP
```

The utility verifies the file, then starts updating the BIOS file.

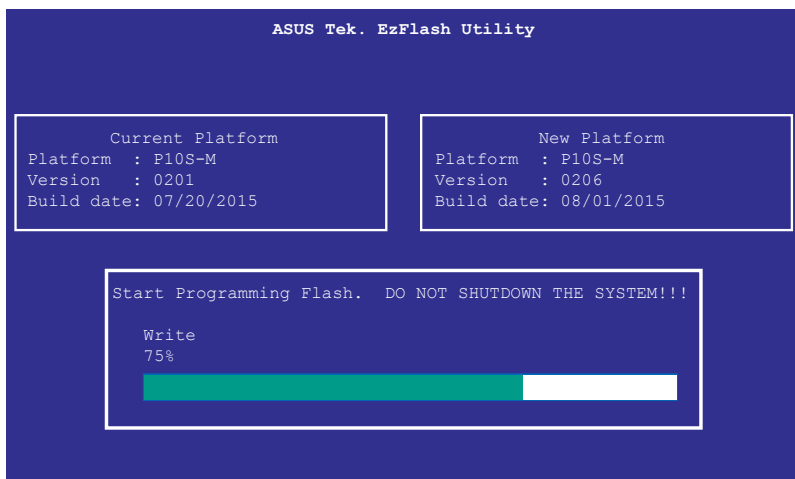

DO NOT shut down or reset the system while updating the BIOS to prevent system boot failure!

The utility returns to the DOS prompt after the BIOS update process is completed.

4. Reboot the system from the hard disk drive.

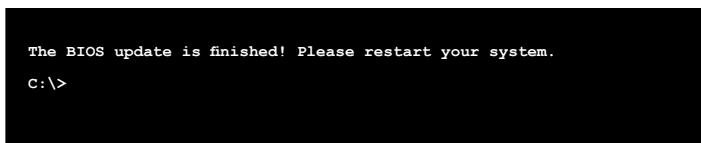

4.2 BIOS setup program

This motherboard supports a programmable firmware chip that you can update using the provided utility described in section 4.1 **Managing and updating your BIOS**.

Use the BIOS Setup program when you are installing a motherboard, reconfiguring your system, or prompted to “Run Setup.” This section explains how to configure your system using this utility.

Even if you are not prompted to use the Setup program, you can change the configuration of your computer in the future. For example, you can enable the security password feature or change the power management settings. This requires you to reconfigure your system using the BIOS Setup program so that the computer can recognize these changes and record them in the CMOS RAM of the firmware chip.

The firmware chip on the motherboard stores the Setup utility. When you start up the computer, the system provides you with the opportunity to run this program. Press during the Power-On Self-Test (POST) to enter the Setup utility; otherwise, POST continues with its test routines.

If you wish to enter Setup after POST, restart the system by pressing <Ctrl>+<Alt>+, or by pressing the reset button on the system chassis. You can also restart by turning the system off then back on. Do this last option only if the first two failed.

The Setup program is designed to make it as easy to use as possible. Being a menu-driven program, it lets you scroll through the various sub-menus and make your selections from the available options using the navigation keys.



-
- The default BIOS settings for this motherboard apply for most conditions to ensure optimum performance. If the system becomes unstable after changing any BIOS settings, load the default settings to ensure system compatibility and stability. Press <F5> and select **Yes** to load the BIOS default settings.
 - The BIOS setup screens shown in this section are for reference purposes only, and may not exactly match what you see on your screen.
 - Visit the ASUS website (www.asus.com) to download the latest BIOS file for this motherboard.
-

4.2.1 BIOS menu screen

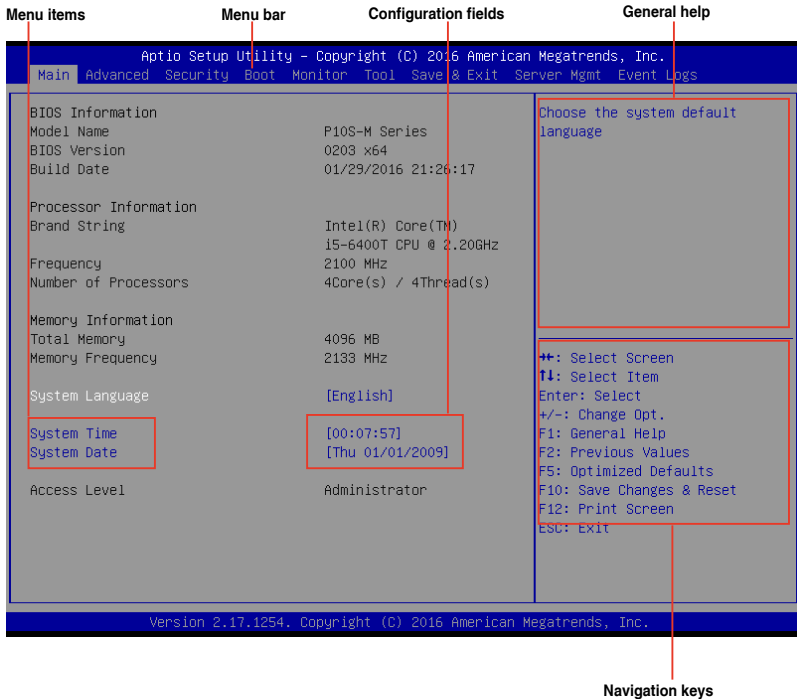

4.2.2 Menu bar

The menu bar on top of the screen has the following main items:

- | | |
|------------------------|--|
| Main | For changing the basic system configuration |
| Advanced | For changing the advanced system settings |
| Security | For changing the security settings |
| Boot | For changing the system boot configuration |
| Monitor | For displaying the system temperature, power status, and changing the fan settings |
| Tool | For configuring options for special functions |
| Save & Exit | For selecting the save & exit options |
| Server Mgmt | For changing the server mgmt settings |
| Event Logs | For changing the event log settings |

To select an item on the menu bar, press the right or left arrow key on the keyboard until the desired item is highlighted.

4.2.3 Menu items

The highlighted item on the menu bar displays the specific items for that menu. For example, selecting **Main** shows the Main menu items. The other items (Advanced, Security, Boot, Monitor, Tool, Save & Exit, Server Mgmt and Event Logs) on the menu bar have their respective menu items.

4.2.4 Submenu items

A solid triangle before each item on any menu screen means that the item has a submenu. To display the submenu, select the item and press <Enter>.

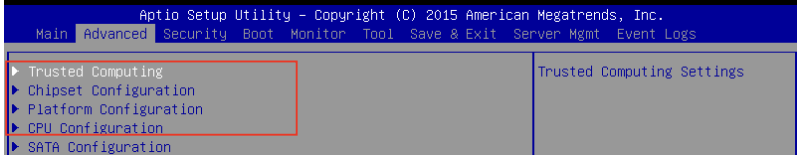

4.2.5 Navigation keys

At the bottom right corner of a menu screen are the navigation keys for the BIOS setup program. Use the navigation keys to select items in the menu and change the settings.

4.2.6 General help

At the top right corner of the menu screen is a brief description of the selected item.

4.2.7 Configuration fields

These fields show the values for the menu items. If an item is user-configurable, you can change the value of the field opposite the item. You cannot select an item that is not user-configurable. A configurable field is enclosed in brackets, and is highlighted when selected. To change the value of a field, select it and press <Enter> to display a list of options.

4.2.8 Pop-up window

Select a menu item and press <Enter> to display a pop-up window with the configuration options for that item.

4.2.9 Scroll bar

A scroll bar appears on the right side of a menu screen when there are items that do not fit on the screen. Press the Up/Down arrow keys or <Page Up> /<Page Down> keys to display the other items on the screen.

4.3 Main menu

When you enter the BIOS Setup program, the Main menu screen appears. The Main menu provides you an overview of the basic system information, and allows you to set the system date and time.

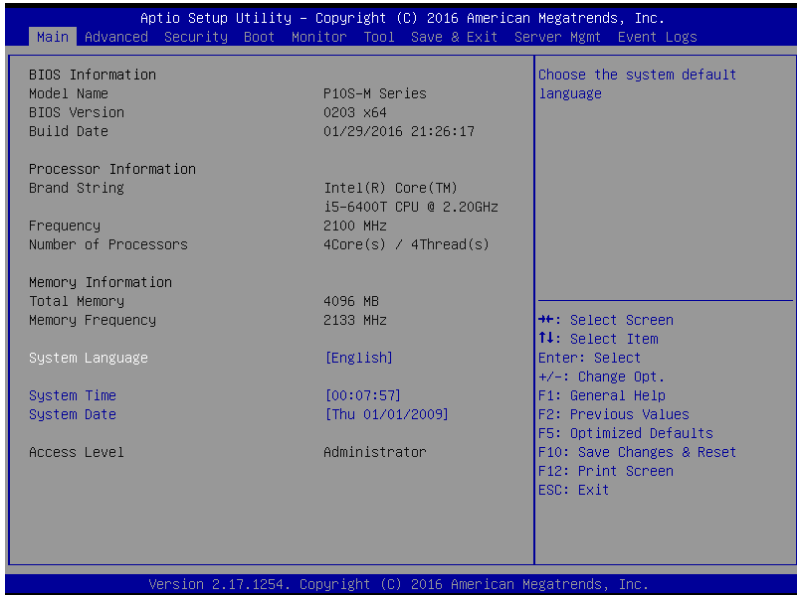

4.3.1 System Date [Day xx/xx/xxxx]

Allows you to set the system date.

4.3.2 System Time [xx:xx:xx]

Allows you to set the system time.

4.4 Advanced menu

The Advanced menu items allow you to change the settings for the CPU and other system devices.



Take caution when changing the settings of the Advanced menu items. Incorrect field values can cause the system to malfunction.

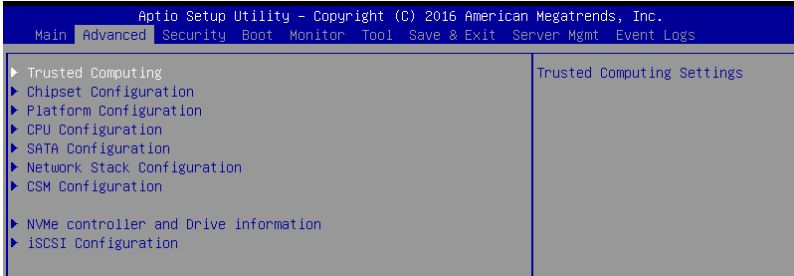

4.4.1 Trusted Computing

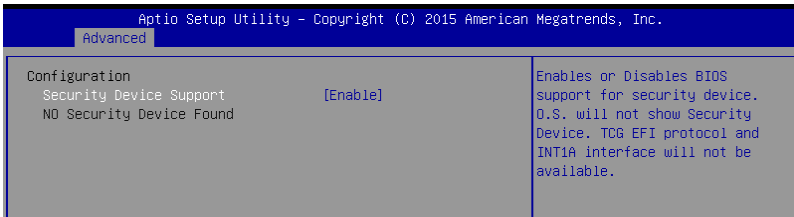

Configuration

Security Device Support [Enabled]

Allows you to enable or disable the BIOS support for security device.

Configuration options: [Disabled] [Enabled]

4.4.2 Chipset Configuration

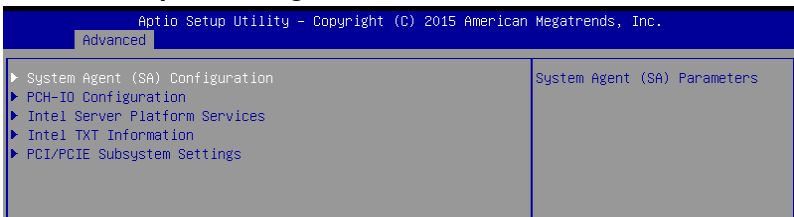

System Agent (SA) Configuration

Allows you to set System Agent (SA) parameters.

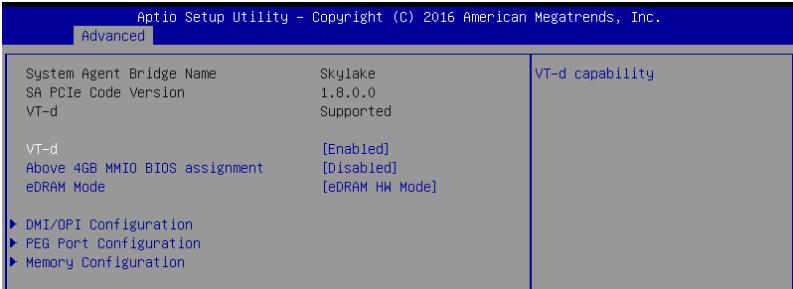

VT-d [Enabled]

Allows you to enable virtualization technology function on memory control hub.

Configuration options: [Disabled] [Enabled]

Above 4GB MMIO BIOS assignment [Disabled]

Allows you to enable or disable above 4GB MemoryMappedIO BIOS assignment. When aperture size is set to 2048 MB, this is disabled automatically.

Configuration options: [Enabled] [Disabled]

eDRAM Mode [eDRAM HW Mode]

Allows you to enable or disable SW Mode eDRAM.

Configuration options: [SW Mode eDRAM Off] [SW Mode eDRAM On] [eDRAM HW Mode]

DMI/OPI Configuration

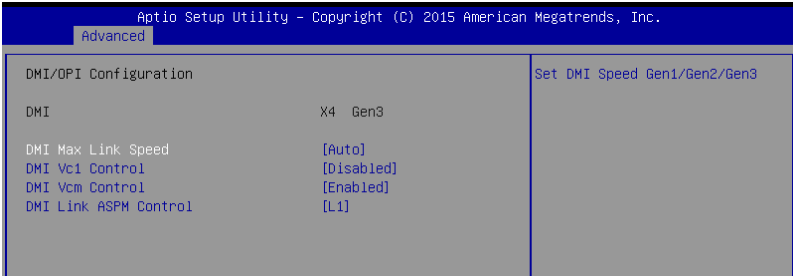

DMI Max Link Speed [Auto]

Allows you to set the DMI speed.

Configuration options: [Auto] [Gen1] [Gen2] [Gen3]

DMI Vc1 Control [Disabled]

Allows you to enable or disable DMI Vc1.

Configuration options: [Enabled] [Disabled]

DMI Vcm Control [Enabled]

Allows you to enable or disable DMI Vcm.
Configuration options: [Enabled] [Disabled]

DMI Link ASPM Control [L1]

This item is for the control of the Active State Power Management on SA side of the DMI link.
Configuration options: [Disabled] [L1]

PEG Port Configuration

Aptio Setup Utility - Copyright (C) 2015 American Megatrends, Inc.	
Advanced	
PEG Port Configuration	Enable or Disable the Root Port
PEG 0:1:0	Not Present
Enable Root Port	[Auto]
Max Link Speed	[Auto]
Max Link Width	[Auto]
Power Down Unused Lanes	[Auto]
ASPM	[Auto]
PEG0 Max Payload size	[Auto]
Program PCIe ASPM after OpROM	[Disabled]

PEG 0:1:0

Enable Root Port [Auto]

Allows you to enable or disable the root port.
Configuration options: [Disabled] [Enabled] [Auto]

Max Link speed [Auto]

Allows you to configure PEG 0:1:0 Max Speed.
Configuration options: [Auto] [Gen1] [Gen2] [Gen3]

Max Link Width [Auto]

Allows you to force PEG link to retrain selected value.
Configuration options: [Auto] [Force X1] [Force X2] [Force X4] [Force X8]

Power Down Unused Lanes [Auto]

Allows you to power down unused lanes.
[Disabled] No power saving.
[Auto] BIOS will power down unused lanes based in the max possible link width.

ASPM [Auto]

Allows you to configure the PCIe ASPM.
Configuration options: [Disabled] [Auto] [ASPM L0s] [ASPM L1] [ASPM L0sL1]

PEG0 Max Payload size [Auto]

Allows you to set the PEG0 max payload size.
Configuration options: [Auto] [128 TLP] [256 TLP]

Program PCIe ASPM after OpRom [Disabled]

Allows you to select when to program the PCIe ASPM.
[Disabled] PCIe ASPM will be programmed before OpROM.
[Enabled] PCIe ASPM will be programmed after OpROM.

Memory Configuration

Aptio Setup Utility - Copyright (C) 2016 American Megatrends, Inc.		
Advanced		
Memory Configuration		Maximum Memory Frequency Selections in MHz.
Memory RC Version	1.8.0.1	
Memory Frequency	2133 MHz	
Total Memory	4096 MB	
DIMM#A1	Not Present	
DIMM#A2	4096 MB	
DIMM#B1	Not Present	
DIMM#B2	Not Present	
Maximum Memory Frequency	[Auto]	
Max TOLUD	[Dynamic]	
Memory Scrambler	[Enabled]	
Memory Remap	[Enabled]	
		+*: Select Screen
		F1: Select Item

Maximum Memory Frequency [Auto]

Allows you to set the maximum memory frequency.

Configuration options: [Auto] [1067] [1333] [1600] [1867] [2133]

Max TOLUD [Dynamic]

Allows you to set the maximum value of TOLUD. Dynamic assignment would adjust TOLUD automatically based on largest MMIO length of installed graphic controller.

Configuration options: [Dynamic] [1 GB] [1.25 GB] [1.5 GB] [1.75 GB] [2 GB] [2.25 GB] [2.5 GB] [2.75 GB] [3 GB] [3.25 GB] [3.5 GB]

Memory Scrambler [Enabled]

Set this item to enable or disable memory scrambler support.

Configuration options: [Disabled] [Enabled]

Memory Remap [Enabled]

Allows you to enable or disable memory remap above 4GB.

Configuration options: [Enabled] [Disabled]

PCH-IO Configuration

Allows you to set PCH-IO parameters.

Aptio Setup Utility - Copyright (C) 2016 American Megatrends, Inc.		
Advanced		
Intel PCH RC Version	1.8.0.0	PCI Express Configuration settings
▶ PCI Express Configuration		
▶ USB Configuration		
Disable DSX ACPRESENT PullDown	[Disabled]	
CLKRUN# Logic	[Enabled]	
Serial IRQ Mode	[Continuous]	
High Precision Timer	[Enabled]	

PCI Express Configuration

Aptio Setup Utility - Copyright (C) 2015 American Megatrends, Inc.		
Advanced		
PCI Express Configuration		Enable or disable PCI Express Clock Gating for each root port.
PCI Express Clock Gating	[Enabled]	
DMI Link ASPM Control	[Enabled]	

PCI Express Clock Gating [Enabled]

Allows you to enable or disable PCI Express Clock Gating for each root port.
Configuration options: [Disabled] [Enabled]

DMI Link ASPM Control [Enabled]

Allows you to enable or disable the control of Active State Power Management on SA side of the DMI link.
Configuration options: [Disabled] [Enabled]

USB Configuration

Aptio Setup Utility - Copyright (C) 2015 American Megatrends, Inc.		
Advanced		
USB Configuration		Precondition work on USB host controller and root ports for faster enumeration.
USB Precondition	[Disabled]	
xDCI Support	[Disabled]	
USB Port Disable Override	[Disabled]	

USB Precondition [Disabled]

Allows you to precondition work on USB host controller and root ports for faster enumeration.
Configuration options: [Enabled] [Disabled]

xDCI Support [Disabled]

Allows you to enable or disable xDCI (USB OTG Device).
Configuration options: [Disabled] [Enabled]

USB Port Disable Override [Disabled]

Allows you to enable or disable the corresponding USB port from reporting a Device Connection to the controller.
Configuration options: [Disabled] [Select Per-Pin]

Disable DSX ACPRESENT PullDown [Disabled]

Allows you to disable PCH internal ACPRESENT PullDown when DeepSx or G3 exit.
Configuration options: [Enabled] [Disabled]

CLKRUN# Logic [Enabled]

Allows you to enable or disable the CLKRUN# logic to stop the PCI clocks.
Configuration options: [Disabled] [Enabled]

Serial IRQ Mode [Continuous]

Allows you to configure Serial IRQ mode.
Configuration options: [Quiet] [Continuous]

High Precision Timer [Enabled]

Allows you to enable or disable the High Precision Event Timer.
Configuration options: [Disabled] [Enabled]

Intel Server Platform Services

Aptio Setup Utility - Copyright (C) 2016 American Megatrends, Inc.

Advanced

Intel Server Platform Services Configuration	
ME BIOS Interface Version	1.2
SPS Version	2308.0.3.89
ME FW Status Value	: 0xF0345
ME FW State	: SPS ME FW Active
ME FW Operation State	: M0 without UMA
ME FW Error Code	: No Error
ME NM FW Status Value	: 0x0
BIOS Booting Mode	: Power Optimized mode
Cores Disabled	: 0
ME FW SKU Information	: SiEn
End-of-POST Status	: EOP disabled in POST

+*: Select Screen
F1: Select Item

Intel TXT Information

Aptio Setup Utility - Copyright (C) 2015 American Megatrends, Inc.

Advanced

Intel TXT Information	
Chipset	Production Fused
BiosAcM	Production Fused
Chipset Txt	Supported
Cpu Txt	Supported
Error Code	None
Class Code	None
Major Code	None
Minor Code	None

PCI/PCIE Subsystem Settings

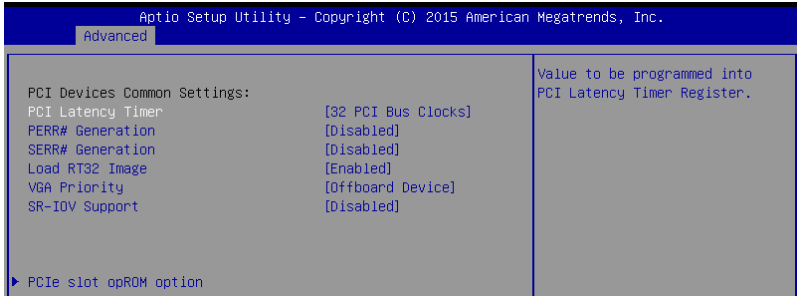

PCI Latency Timer [32 PCI Bus Clocks]

Allows you to set the value to be programmed into PCI Latency Timer Register.
 Configuration options: [32 PCI Bus Clocks] [64 PCI Bus Clocks] [96 PCI Bus Clocks] [128 PCI Bus Clocks] [160 PCI Bus Clocks] [192 PCI Bus Clocks] [224 PCI Bus Clocks] [248 PCI Bus Clocks]

PERR# Generation [Disabled]

Allows you to enable or disable PCI Device tp generation PERR#.
 Configuration options: [Disabled] [Enabled]

SERR# Generation [Disabled]

Allows you to enable or disable PCI Device tp generation SERR#.
 Configuration options: [Disabled] [Enabled]

Load RT32 Image [Enabled]

Allows you to enable or disable RT32 Image Loading.
 Configuration options: [Disabled] [Enabled]

VGA Priority [Offboard Device]

This allows you to prioritize between the onboard and offboard video device to be found.
 Configuration options: [Onboard Device] [Offboard Device]

SR-IOV Support [Disabled]

Allows you to enable or disable Single Root IO Virtualization Support if system has capable PCIe Devices.
 Configuration options: [Disabled] [Enabled]

PCIe slot opROM option

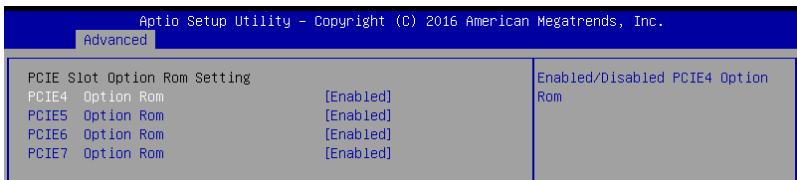

PCIe4 Option ROM [Enabled]

Allows you to enable or disable the PCIe4 Option ROM.
Configuration options: [Disabled] [Enabled]

PCIe5 Option ROM [Enabled]

Allows you to enable or disable the PCIe5 Option ROM.
Configuration options: [Disabled] [Enabled]

PCIe6 Option ROM [Enabled]

Allows you to enable or disable the PCIe6 Option ROM.
Configuration options: [Disabled] [Enabled]

PCIe7 Option ROM [Enabled]

Allows you to enable or disable the PCIe7 Option ROM.
Configuration options: [Disabled] [Enabled]

4.4.3 Platform Configuration

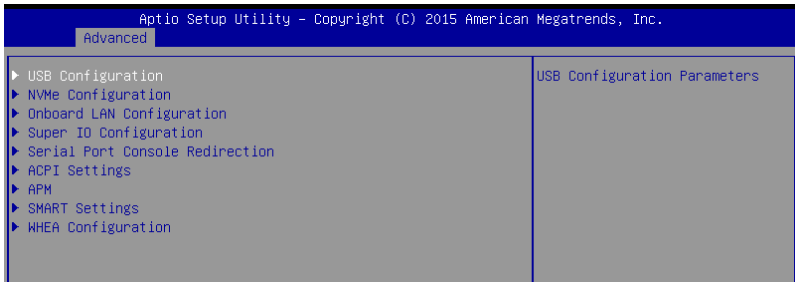

USB Configuration

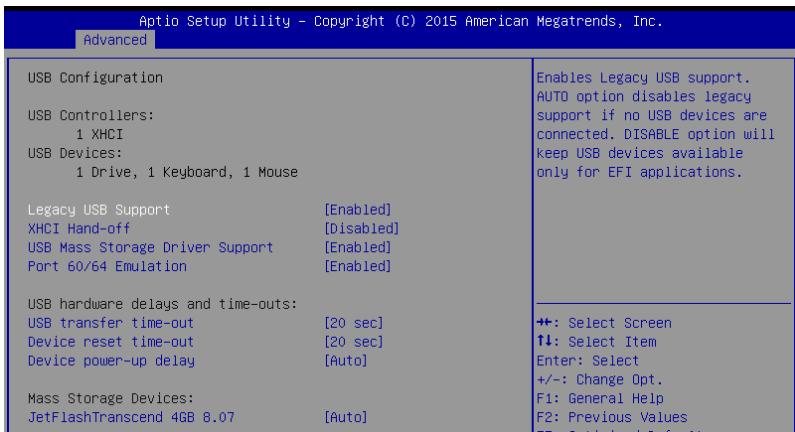

Legacy USB Support [Enabled]

- [Disabled] The USB devices can be used only for the BIOS setup program. It cannot be recognized in boot devices list.
- [Enabled] Enables the support for USB devices on legacy operating systems (OS).
- [Auto] Allows the system to detect the presence of USB devices at startup. If detected, the USB controller legacy mode is enabled. If no USB device is detected, the legacy USB support is disabled.

XHCI Hand-off [Disabled]



This item is set to **[Disabled]** by default for the EHCI (enhanced host controller interface) support by XHCI drivers in operating systems.

- [Enabled] Support XHCI by BIOS for operating systems without XHCI support.
- [Disabled] Support XHCI by XHCI drivers for operating systems with XHCI support.

USB Mass Storage Driver Support [Enabled]

Allows you to enable or disable the USB Mass Storage driver support.
Configuration options: [Disabled] [Enabled]

Port 60/64 Emulation [Enabled]

This allows you to enable the I/O port 60h/64h emulation support. This should be enabled for the complete USB keyboard legacy support for non-USB aware OSes.
Configuration options: [Disabled] [Enabled]

USB hardware delays and time-outs

USB transfer time-out [20 sec]

Allows you to select the USB transfer time-out value.
Configuration options: [1 sec] [5 sec] [10 sec] [20 sec]

Device reset time-out [20 sec]

Allows you to select the USB device reset time-out value.
Configuration options: [10 sec] [20 sec] [30 sec] [40 sec]

Device power-up delay [Auto]

This allows you to set the maximum time the device will take before it properly reports itself to the Host Controller.
Configuration options: [Auto] [Manual]

Mass Storage Devices

Allows you to select the mass storage device emulation type for devices connected.
Configuration options: [Auto] [Floppy] [Forced FDD] [Hard Disk] [CD-ROM]

NVMe Configuration

You may view the NVMe controller and Drive information if an NVMe device is connected.

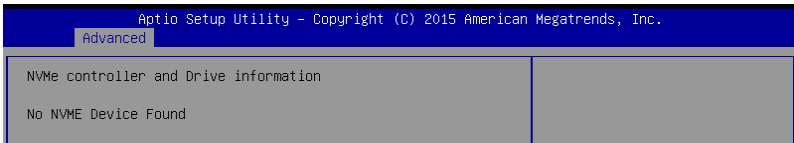

Onboard LAN Configuration

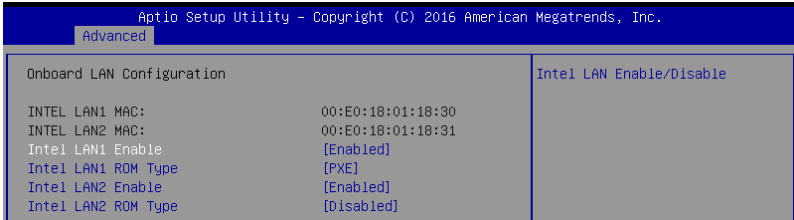

Intel LAN1 Enable [Enabled]

Allows you to enable or disable the Intel LAN.

Configuration options: [Disabled] [Enabled]

Intel LAN ROM Type [PXE]

Allows you to select the Intel LAN ROM type.

Configuration options: [Disabled] [PXE] [iSCSI]

Intel LAN2 Enable [Enabled]

Allows you to enable or disable the Intel LAN.

Configuration options: [Disabled] [Enabled]

Intel LAN ROM Type [Disabled]

Allows you to select the Intel LAN ROM type.

Configuration options: [Disabled] [PXE] [iSCSI]

Super IO Configuration

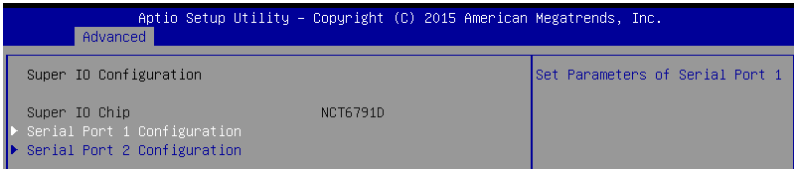

Serial Port 1 Configuration

Allows you to set the parameters of Serial Port 1.

Aptio Setup Utility - Copyright (C) 2015 American Megatrends, Inc.		
Advanced		
Serial Port 1 Configuration		Enable or Disable Serial Port (COM)
Serial Port	[Enabled]	
Device Settings	IO=3F8h; IRQ=4;	
Change Settings	[Auto]	

Serial Port [Enabled]

Allows you to enable or disable Serial Port.

Configuration options: [Disabled] [Enabled]

Change Settings [Auto]

Allows you to choose the setting for Super IO device.

Configuration options: [Auto] [IO=3F8h; IRQ=4;] [IO=3F8h; IRQ=3, 4, 5, 6, 7, 9, 10, 11, 12;] [IO=2F8h; IRQ=3, 4, 5, 6, 7, 9, 10, 11, 12;] [IO=3E8h; IRQ=3, 4, 5, 6, 7, 9, 10, 11, 12;] [IO=2E8h; IRQ=3, 4, 5, 6, 7, 9, 10, 11, 12;]

Serial Port 2 Configuration

Allows you to set the parameters of Serial Port 2.

Aptio Setup Utility - Copyright (C) 2015 American Megatrends, Inc.		
Advanced		
Serial Port 2 Configuration		Enable or Disable Serial Port
Serial Port	[Enabled]	
Device Settings	IO=2F8h; IRQ=3;	
Change Settings	[Auto]	
Change Settings	[Standard Serial Port Mode]	

Serial Port [Enabled]

Allows you to enable or disable Serial Port.

Configuration options: [Disabled] [Enabled]

Change Settings [Auto]

Allows you to choose the setting for Super IO device.

Configuration options: [Auto] [IO=2F8h; IRQ=3;] [IO=3F8h; IRQ=3, 4, 5, 6, 7, 9, 10, 11, 12;] [IO=2F8h; IRQ=3, 4, 5, 6, 7, 9, 10, 11, 12;] [IO=3E8h; IRQ=3, 4, 5, 6, 7, 9, 10, 11, 12;] [IO=2E8h; IRQ=3, 4, 5, 6, 7, 9, 10, 11, 12;]

Serial Port Console Redirection

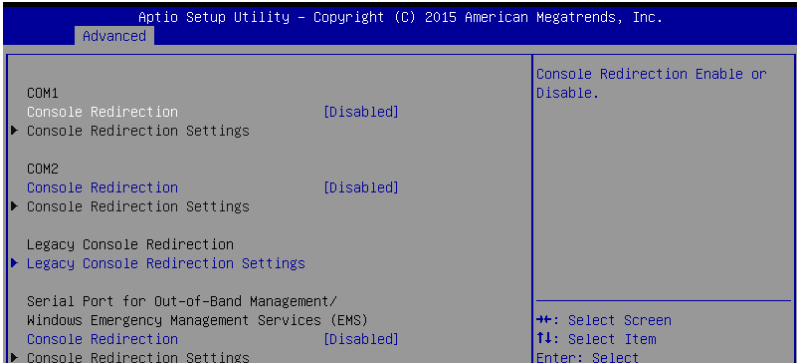

COM1 / COM2

Console Redirection [Disabled]

Allows you to enable or disable the console redirection feature.

Configuration options: [Disabled] [Enabled]



The following item appears only when you set **Console Redirection** to **[Enabled]**.

Console Redirection Settings

This item becomes configurable only when you enable the **Console Redirection** item. The settings specify how the host computer and the remote computer (which the user is using) will exchange data. Both computers should have the same or compatible settings.

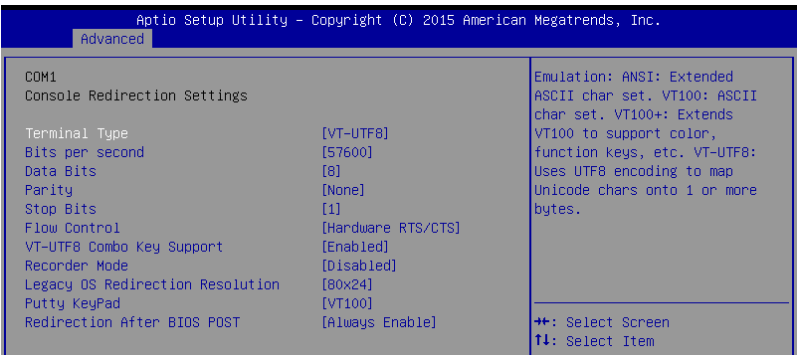

Terminal Type [VT-UTF8]

Allows you to set the terminal type.

- [VT100] ASCII char set.
- [VT100+] Extends VT100 to support color, function keys, etc.
- [VT-UTF8] Uses UTF8 encoding to map Unicode chars onto 1 or more bytes.
- [ANSI] Extended ASCII char set.

Bits per second [57600]

Selects serial port transmission speed. The speed must be matched on the other side. Long or noisy lines may require lower speeds.

Configuration options: [9600] [19200] [38400] [57600] [115200]

Data Bits [8]

Configuration options: [7] [8]

Parity [None]

A parity bit can be sent with the data bits to detect some transmission errors. [Mark] and [Space] parity do not allow for error detection.

[None]	None.
[Even]	parity bit is 0 if the num of 1's in the data bits is even.
[Odd]	parity bit is 0 if num of 1's in the data bits is odd.
[Mark]	parity bit is always 1.
[Space]	parity bit is always 0.

Stop Bits [1]

Stop bits indicate the end of a serial data packet. (A start bit indicates the beginning.) The standard setting is 1 stop bit. Communication with slow devices may require more than 1 stop bit.

Configuration options: [1] [2]

Flow Control [Hardware RTS/CTS]

Flow control can prevent data loss from buffer overflow. When sending data, if the receiving buffers are full, a "stop" signal can be sent to stop the data flow. Once the buffers are empty, a "start" signal can be sent to re-start the flow. Hardware flow control uses two wires to send start/stop signals.

Configuration options: [None] [Hardware RTS/CTS]

VT-UTF8 Combo Key Support [Enabled]

Allows you to enable the VT-UTF8 Combo Key Support for ANSI/VT100 terminals.

Configuration options: [Disabled] [Enabled]

Recorder Mode [Disabled]

With this mode enabled only text will be sent. This is to capture Terminal data.

Configuration options: [Disabled] [Enabled]

Legacy OS Redirection Resolution [80x24]

Allows you to set the number of rows and columns supported on the Legacy OS.

Configuration options: [80x24] [80x25]

Putty Keypad [VT100]

Allows you to select the FunctionKey and Keypad on Putty.

Configuration options: [VT100] [LINUX] [XTERMR6] [SCO] [ESCN] [VT400]

Redirection After BIOS POST [Always Enable]

Allows you to specify if Bootloader is selected than Legacy console redirection.

Configuration options: [Always Enable] [Bootloader]

Legacy Console Redirection Settings

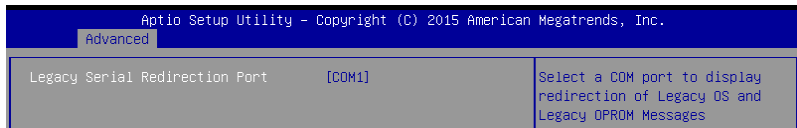

Legacy Serial Redirection Port [COM1]

Allows you to select a COM port to display redirection of Legacy OS and Legacy OPROM Messages.

Configuration options: [COM1] [COM2]

Serial Port for Out-of-Band Management/

Windows Emergency Management Services (EMS)

Console Redirection [Disabled]

Allows you to enable or disable the console redirection feature.

Configuration options: [Disabled] [Enabled]



The following item appears only when you set **Console Redirection** to [Enabled].

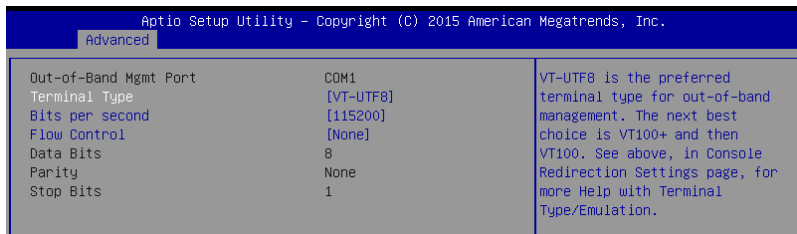

Console Redirection Settings

Out-of-Band Mgmt Port [COM1]

Microsoft Windows Emergency Management Services (EMS) allows for remote management of a Windows Server OS through a serial port.

Configuration options: [COM1] [COM2]

Terminal Type [VT-UTF8]

Allows you to set the terminal type for out-of-band management.

Configuration options: [VT100] [VT100+] [VT-UTF8] [ANSI]

Bits per second [115200]

Allows you to set the serial port transmission speed.

Configuration options: [9600] [19200] [57600] [115200]

Flow Control [None]

Allows you to set the flow control to prevent data loss from buffer overflow.

Configuration options: [None] [Hardware RTS/CTS] [Software Xon/Xoff]

ACPI Settings

Aptio Setup Utility - Copyright (C) 2015 American Megatrends, Inc.		
Advanced		
ACPI Settings		Enables or Disables System ability to Hibernate (OS/S4 Sleep State). This option may be not effective with some OS.
Enable Hibernation	[Enabled]	
ACPI Sleep State	[S3 (Suspend to RAM)]	

Enable Hibernation [Enabled]

Allows you to enable or disable the ability of the system to hibernate (OS/S4 Sleep State).

Configuration options: [Disabled] [Enabled]



This option may be not effective with some OS.

ACPI Sleep State [S3 (Suspend to RAM)]

Allows you to select the highest ACPI sleep state the system will enter when the SUSPEND button is pressed.

Configuration options: [Suspend Disabled] [S3 (Suspend to RAM)]

APM

Allows you to configure the Advance Power Management (APM) settings.

Aptio Setup Utility - Copyright (C) 2015 American Megatrends, Inc.		
Advanced		
Restore AC Power Loss	[Last State]	Specify what state to go to when power is re-applied after a power failure (G3 state).
Power On By PCIE	[Disabled]	
Power On By Ring	[Disabled]	
Power On By RTC	[Disabled]	

Restore AC Power Loss [Last State]

When set to **[Power Off]**, the system goes into off state after an AC power loss. When set to **[Power On]**, the system will reboot after an AC power loss. When set to **[Last State]**, the system goes into either off or on state, whatever the system state was before the AC power loss.

Configuration options: [Power Off] [Power On] [Last State]

Power On By PCIE [Disabled]

[Disabled] Disables the PCIE devices to generate a wake event.

[Enabled] Enables the PCIE devices to generate a wake event.

Power On By Ring [Disabled]

- [Disabled] Disables the Ring devices to generate a wake event.
- [Enabled] Enables the Ring devices to generate a wake event.



This item functions only if there is a serial port (COM1) connector on the motherboard.

Power On By RTC [Disabled]

- [Disabled] Disables RTC to generate a wake event.
- [Enabled] When set to [Enabled], the items RTC Alarm Date (Days) and Hour/Minute/Second will become user-configurable with set values.

SMART Settings

Aptio Setup Utility - Copyright (C) 2015 American Megatrends, Inc.	
Advanced	
SMART Settings	Run SMART Self Test on all HDDs during POST.
SMART Self Test	[Enabled]

SMART Self Test [Enabled]

Allows you to run SMART Self Test on all HDDs during POST.
Configuration options: [Disabled] [Enabled]

WHEA Configurations

Aptio Setup Utility - Copyright (C) 2015 American Megatrends, Inc.	
Advanced	
WHEA Support	[Enabled]
Enable or disable Windows Hardware Error Architecture.	

WHEA Support [Enabled]

This item allows you to enable or disable the WHEA support.
Configuration options: [Disabled] [Enabled]

4.4.4 CPU Configuration

The items in this menu show the CPU-related information that the BIOS automatically detects. Some items may not appear if your CPU does not support the related functions.

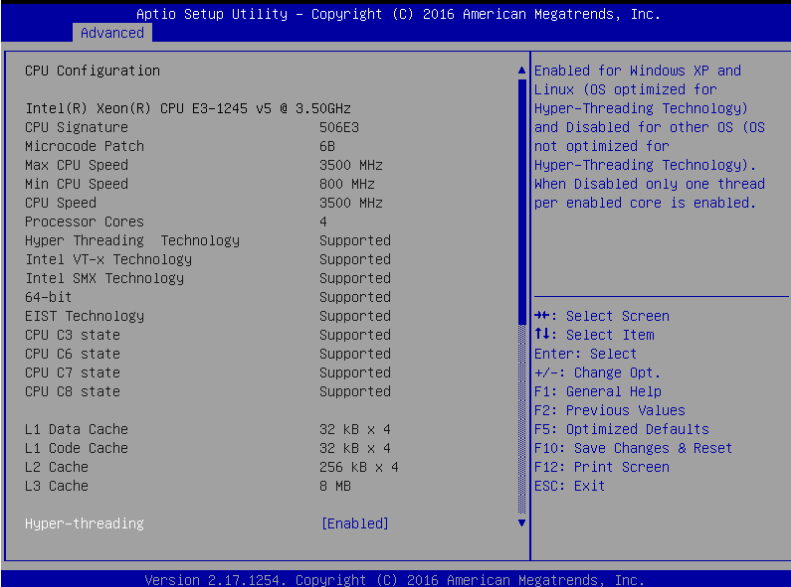

The screenshot shows the 'Advanced' page of the Aptio Setup Utility. The title bar reads 'Aptio Setup Utility - Copyright (C) 2016 American Megatrends, Inc.' and the sub-header is 'Advanced'. The main content is divided into two columns. The left column lists CPU configuration items, and the right column shows the status of 'Hyper-threading' and a list of navigation keys.

CPU Configuration	
Intel(R) Xeon(R) CPU E3-1245 v5 @ 3.50GHz	
CPU Signature	506E3
Microcode Patch	6B
Max CPU Speed	3500 MHz
Min CPU Speed	800 MHz
CPU Speed	3500 MHz
Processor Cores	4
Hyper Threading Technology	Supported
Intel VT-x Technology	Supported
Intel SMX Technology	Supported
64-bit	Supported
EIST Technology	Supported
CPU C3 state	Supported
CPU C6 state	Supported
CPU C7 state	Supported
CPU C8 state	Supported
L1 Data Cache	32 kB x 4
L1 Code Cache	32 kB x 4
L2 Cache	256 kB x 4
L3 Cache	8 MB
Hyper-threading	[Enabled]

Enabled for Windows XP and Linux (OS optimized for Hyper-Threading Technology) and Disabled for other OS (OS not optimized for Hyper-Threading Technology). When Disabled only one thread per enabled core is enabled.

++: Select Screen
↑↓: Select Item
Enter: Select
+/-: Change Opt.
F1: General Help
F2: Previous Values
F5: Optimized Defaults
F10: Save Changes & Reset
F12: Print Screen
ESC: Exit

Version 2.17.1254. Copyright (C) 2016 American Megatrends, Inc.

Navigate to the second page of the screen to see the rest of items in this menu by pressing the Up or Down arrow keys.



To quickly go to the last item of the second page, press the **Page Down** button. Press the **Page Up** button to go back to the first item in the first page.

Hyper-threading [Enabled]

This item allows a hyper-threading processor to appear as two logical processors, allowing the operating system to schedule two threads or processors simultaneously.

Configuration options: [Disabled] [Enabled]

Active Processor Cores [All]

Allows you to select the number of CPU cores to activate in each processor package.

Configuration options: [All] [1] [2] [3]

Intel Virtualization Technology [Enabled]

When set to [Enabled], a VMM can utilize the additional hardware capabilities provided by Vanderpool Technology.

Configuration options: [Disabled] [Enabled]

Hardware Prefetcher [Enabled]

Allows you to enable or disable the MLC streamer prefetcher.

Configuration options: [Disabled] [Enabled]

Adjacent Cache Line Prefetch [Enabled]

This item allows you to enable or disable prefetching of adjacent cache lines.
Configuration options: [Disabled] [Enabled]

CPU AES [Enabled]

Allows you to enable or disable the CPU Advance Encryption Standard instructions.
Configuration options: [Disabled] [Enabled]

Boot performance mode [Max Non-Turbo Performance]

Allows you to select the CPU performance state during system boot before the operating system takes control. The CPU runs at a selected performance ratio based on CPU configuration.

Configuration options: [Max Battery] [Max Non-Turbo Performance] [Turbo Performance]

Intel(R) Speed Shift Technology [Enabled]

Allows you to enable or disable Intel(R) Speed Shift Technology support. Enabling will expose the CPPC v2 interface to allow for hardware controlled P-states.

Configuration options: [Disabled] [Enabled]

Intel(R) SpeedStep(tm) [Enabled]

Allows your system to adjust the CPU's voltage and cores frequency, resulting in decreased power consumption and heat production.

[Disabled] The CPU runs at its default speed.

[Enabled] The system controls the CPU speed.



The following item appears only when you set **Intel(R) SpeedStep(tm)** to **[Enabled]**.

Turbo Mode [Enabled]

This item allows you to automatically set the CPU cores to run faster than the base operating frequency when it is below the operating power, current and temperature specification limit.

Configuration options: [Disabled] [Enabled]

CPU C states [Enabled]

Allows you to enable or disable the CPU C states.

Configuration options: [Disabled] [Enabled]



The following items appear only when you set the **CPU C states** to **[Enabled]**.

Enhanced C-States [Enabled]

This item allows you to enable or disable C1E. When **[Enabled]** is selected, CPU will switch to minimum speed when all cores enter C-State.

Configuration options: [Disabled] [Enabled]

C-State Auto Demotion [C1 and C3]

Allows you to enable or disable the demotion of the C-State.

Configuration options: [Disabled] [C1] [C3] [C1 and C3]

C-State Un-demotion [C1 and C3]

Allows you to enable or disable the un-demotion of the C-State.
Configuration options: [Disabled] [C1] [C3] [C1 and C3]

Package C state demotion [Enabled]

Allows you to enable or disable the Package C state demotion.
Configuration options: [Disabled] [Enabled]

Package C state undemotion [Enabled]

Allows you to enable or disable the Package C state undemotion.
Configuration options: [Disabled] [Enabled]

CState Pre-Wake [Enabled]

Allows you to enable or disable the CState Pre-Wake. Selecting **[Disabled]** will set bit 30 of POWER_CTL MSR(0x1FC) to 1 to disable the CState Pre-Wake.
Configuration options: [Disabled] [Enabled]

Package C State limit [C8]

Allows you set the Package C State limit.
Configuration options: [C0/C1] [C2] [C3] C6] [C7] [C7s] [C8] [AUTO]

CFG lock [Enabled]

Allows you to configure MSR 0xE2[15], CFG lock bit.
Configuration options: [Disabled] [Enabled]

Intel TXT(LT) Support [Disabled]

Allows you to enable or disable the Intel(R) TXT(LT) support.
Configuration options: [Disabled] [Enabled]

4.4.5 SATA Configuration

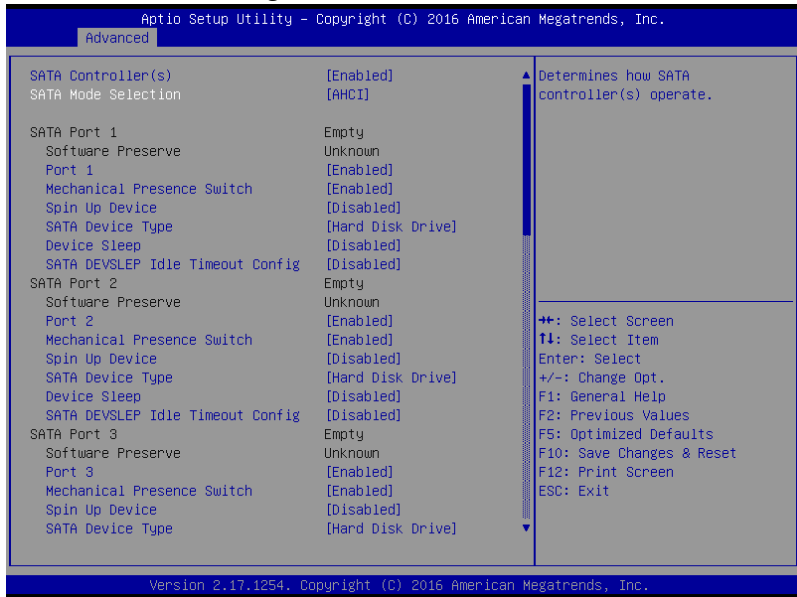

SATA Controller(s) [Enabled]

Allows you to enable or disable the SATA Device.

Configuration options: [Enabled] [Disabled]



The following items appear only when you set **SATA Controller(s)** to **[Enabled]**.

SATA Mode Selection [AHCI]

This item allows you to set the SATA configuration.

[AHCI]

Set to [AHCI] when you want the SATA hard disk drives to use the AHCI (Advanced Host Controller Interface). The AHCI allows the onboard storage driver to enable advanced Serial ATA features that increases storage performance on random workloads by allowing the drive to internally optimize the order of commands.

[RAID]

Set to [RAID] when you want to create a RAID configuration from the SATA hard disk drives.



The following item appears only when you set **SATA Mode Selection** to **[RAID]**.

Software Feature Mask Configuration

Aptio Setup Utility - Copyright (C) 2015 American Megatrends, Inc.		
Advanced		
RAID0	[Enabled]	Enable or disable RAID0 feature.
RAID1	[Enabled]	
RAID10	[Enabled]	
RAID5	[Enabled]	
Intel Rapid Recovery Technology	[Enabled]	
OROM UI and BANNER	[Enabled]	
HDD Unlock	[Enabled]	
LED Locate	[Enabled]	
IRRT Only on eSATA	[Enabled]	
Smart Response Technology	[Enabled]	
OROM UI Normal Delay	[4 sec]	
RST Force Form	[Disabled]	

RAID0 [Enabled]

Allows you to enable or disable the RAID0 feature.

Configuration options: [Disabled] [Enabled]

RAID1 [Enabled]

Allows you to enable or disable the RAID1 feature.

Configuration options: [Disabled] [Enabled]

RAID10 [Enabled]

Allows you to enable or disable the RAID10 feature.

Configuration options: [Disabled] [Enabled]

RAID5 [Enabled]

Allows you to enable or disable the RAID5 feature.

Configuration options: [Disabled] [Enabled]

Intel Rapid Recovery Technology [Enabled]

Allows you to enable or disable the Intel Rapid Recovery Technology.

Configuration options: [Disabled] [Enabled]

OROM UI and BANNER [Enabled]

[Disabled] No OROM banner or information will be displayed if all disks and RAID volumes are Normal.

[Enabled] OROM UI is shown.

HDD Unlock [Enabled]

Selecting [Enabled] will indicate that the HDD password unlock in the OS is enabled.

Configuration options: [Disabled] [Enabled]

LED Locate [Enabled]

Selecting [Enabled] will indicate that the LED/SGPIO hardware is attached and ping to locate feature is enabled on the OS.

Configuration options: [Disabled] [Enabled]

IRRT Only on eSATA [Enabled]

[Disabled] Any RAID volume can span internal and eSATA drives.

[Enabled] Only IRRT volumes can span internal and eSATA drives.

Smart Response Technology [Enabled]

Allows you to enable or disable the Smart Response Technology.

Configuration options: [Disabled] [Enabled]

OROM UI Normal Delay [4 sec]

Allows you to select the delay time of the OROM UI Splash Screen in a normal status.

Configuration options: [2 sec] [4 sec] [6 sec] [8 sec]

RST Force Form [Disabled]

Allows you to enable or disable Form for Intel Rapid Storage Technology.

Configuration options: [Disabled] [Enabled]

**SATA Port 1 / SATA Port 2 / SATA Port 3 / SATA Port 4 / SATA Port 5 /
SATA Port 6****Port 1 / Port 2 / Port 3 / Port 4 / Port 5 / Port 6 [Enabled]**

Allows you to enable or disable the SATA port.

Configuration options: [Disabled] [Enabled]

Mechanical Presence Switch [Enabled]

Allows control of reporting if this port has a Mechanical Presence Switch.

Configuration options: [Disabled] [Enabled]

Spin Up Device [Disabled]

Selecting **[Enabled]** will start a COMERSET initialization sequence to the device on an edge detect from 0 to 1.

Configuration options: [Disabled] [Enabled]

SATA Device Type [Hard Disk Drive]

Allows you to set whether the SATA port is connected to Solid State Drive or Hard Disk Drive.

Configuration options: [Hard Disk Drive] [Solid State Drive]

Device Sleep [Disabled]

Allows you to enable or disable the mSata for RTD3.

Configuration Options: [Disabled] [Enabled]

SATA DEVSLEP Idle Timeout Config [Disabled]

Allows you to enable or disable SATA DTIO Config.

Configuration options: [Disabled] [Enabled]

4.4.6 Network Stack Configuration

Aptio Setup Utility - Copyright (C) 2015 American Megatrends, Inc.		
Advanced		
Network Stack	[Disabled]	Enable/Disable UEFI Network Stack

Network Stack [Disabled]

Allows you to enable or disable UEFI Network Stack.

Configuration options: [Disabled] [Enabled]



The following items appear only when you set the **Network Stack** to **[Enabled]**.

Ipv4 PXE Support [Enabled]

Enables or disables the Ipv4 PXE Boot Support. If disabled, Ipv4 PXE boot option will not be created.

Configuration options: [Disable] [Enable]

Ipv6 PXE Support [Enabled]

Enables or disables the Ipv6 PXE Boot Support. If disabled, Ipv6 PXE boot option will not be created.

Configuration options: [Disable] [Enable]

PXE boot wait time [0]

Set the wait time to press ESC key to abort the PXE boot. Use the <+> or <-> to adjust the value. The values range from 0 to 5.

Media detect count [1]

Set the number of times presence of media will be checked. Use the <+> or <-> to adjust the value. The values range from 1 to 50.

4.4.7 CSM Configuration

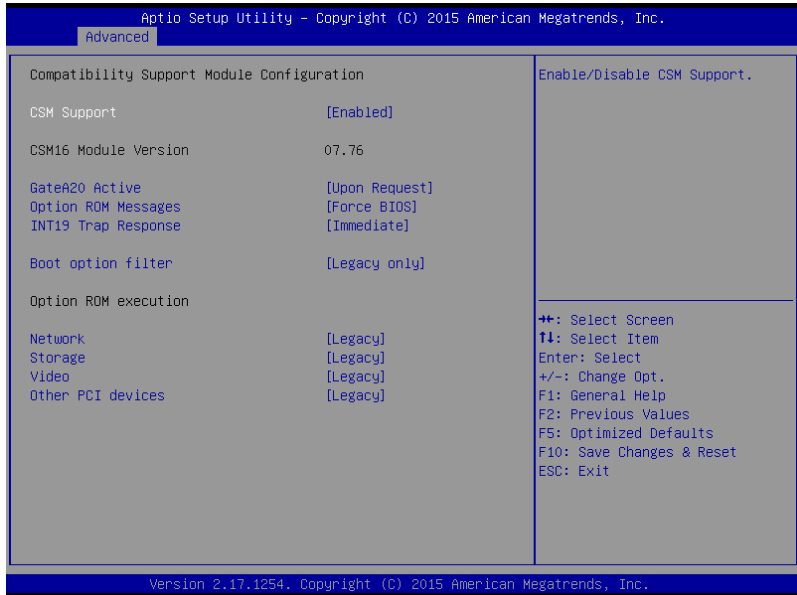

CSM Support [Enabled]

This option allows you to enable or disable CSM Support.

Configuration options: [Disabled] [Enabled]



The following items appear only when you set the **CSM Support** to **[Enabled]**.

GateA20 Active [Upon Request]

This allows you to set the GA20 option.

[Upon Request] GA20 can be disabled using BIOS services.

[Always] Do not allow disabling GA20; this option is useful when any RT code is executed above 1MB.

Option ROM Messages [Force BIOS]

This allows you to set the display mode for option ROM.

Configuration options: [Force BIOS] [Keep Current]

INT19 Trap Response [Immediate]

This option allows you to control the BIOS reaction on INT19 trapping by Option ROM.

[Immediate] Execute the trap right away.

[Postponed] Execute the trap during legacy boot.

Boot Option filter [Legacy only]

This option allows you to control the Legacy/UEFI ROMs priority.

Configuration options: [UEFI and Legacy] [Legacy only] [UEFI only]

Network / Storage / Video [Legacy]

This option allows you to control the execution of UEFI and Legacy PXE/ Storage/ Video OpROM.

Configuration options: [UEFI] [Legacy]

Other PCI devices [Legacy]

This item determines the OpROM execution policy for devices other than Network, Storage, or Video.

Configuration options: [UEFI] [Legacy]

NVMe controller and Drive information

You may view the NVMe controller and Drive information if an NVMe device is connected.

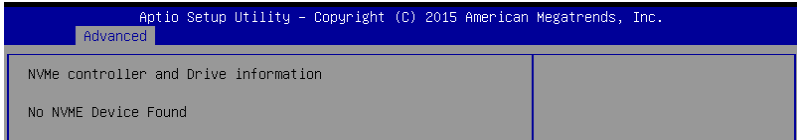

4.4.8 iSCSI Configuration

Allows you to configure the iSCSi parameters.

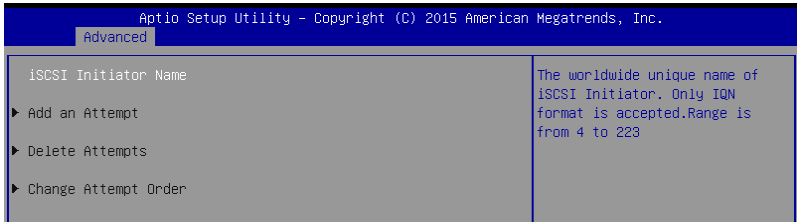

4.5 Security Menu

This menu allows a new password to be created or a current password to be changed. The menu also enables or disables the Secure Boot state and lets the user configure the System Mode state.

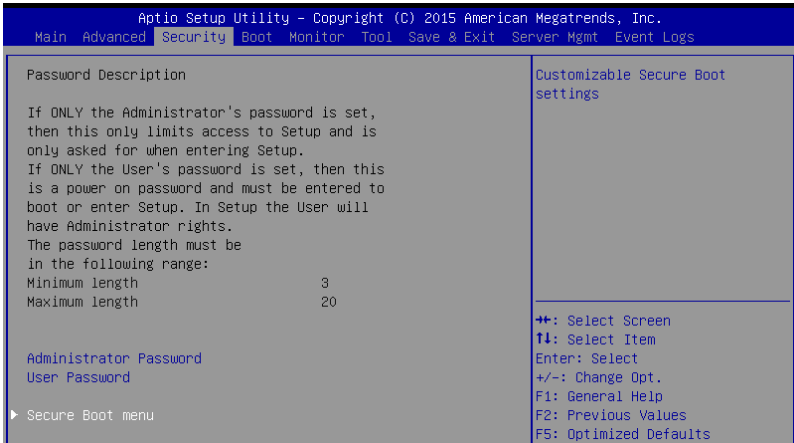

Administrator Password

To set an administrator password:

1. Select the Administrator Password item and press <Enter>.
2. From the Create New Password box, key in a password, then press <Enter>.
3. Confirm the password when prompted.

To change an administrator password:

1. Select the Administrator Password item and press <Enter>.
2. From the Enter Current Password box, key in the current password, then press <Enter>.
3. From the Create New Password box, key in a new password, then press <Enter>.
4. Confirm the password when prompted.



To clear the administrator password, follow the same steps as in changing an administrator password, but press <Enter> when prompted to create/confirm the password.

User Password

To set a user password:

1. Select the User Password item and press <Enter>.
2. From the Create New Password box, key in a password, then press <Enter>.
3. Confirm the password when prompted.

To change a user password:

1. Select the User Password item and press <Enter>.
2. From the Enter Current Password box, key in the current password, then press <Enter>.
3. From the Create New Password box, key in a new password, then press <Enter>.
4. Confirm the password when prompted.

Secure Boot Menu

This item allows you to customize the Secure Boot settings.

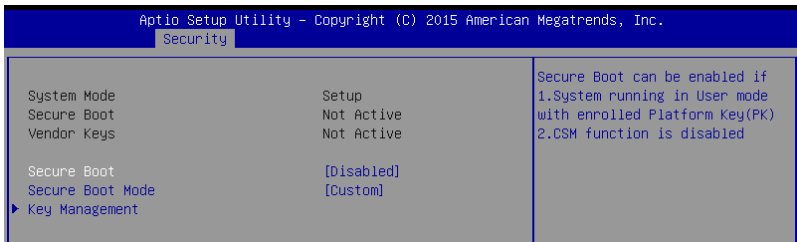

Secure Boot [Disabled]

This item allows you to enable or disable the Secure Boot flow control.

Configuration options: [Disabled] [Enabled]

Secure Boot Mode [Custom]

This item allows you to select the mode of the Secure boot to change Execution policy and Secure Boot Key management.

Configuration options: [Standard] [Custom]

Key Management

This item only appears when you set the **Secure Boot Mode** to **[Custom]**. This allows you to modify Secure Boot variables and set Key Management page.

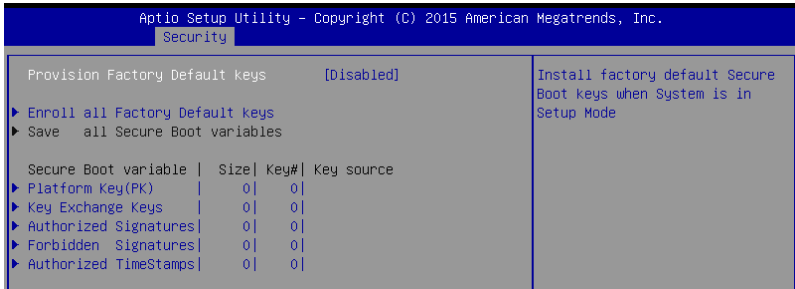

Provision Factory Default Keys [Disabled]

Configuration options: [Disabled] [Enabled]

Enroll All Factory Default Keys / Delete all Secure Boot variables

This item will ask you if you want to Install Factory Default secure variables. Select Yes if you want to load the default secure variables, otherwise select No. This option will change to **Delete all Secure Boot variables** once default keys are loaded, selecting this will then ask to delete all variables and reset the Platform to Setup Mode.



The following item is only available when default secure variables are loaded.

Save all Secure Boot variables

Save the secure boot variables to a selected file system.

Platform Key (PK)

Configuration options: [Set New Key] [Delete Key]

Key Exchange Keys / Authorized Signatures / Forbidden Signatures / Authorized TimeStamps

Configuration options: [Set New Key] [Delete Key] [Append Key]

4.6 Boot Menu

The Boot menu items allow you to change the system boot options.

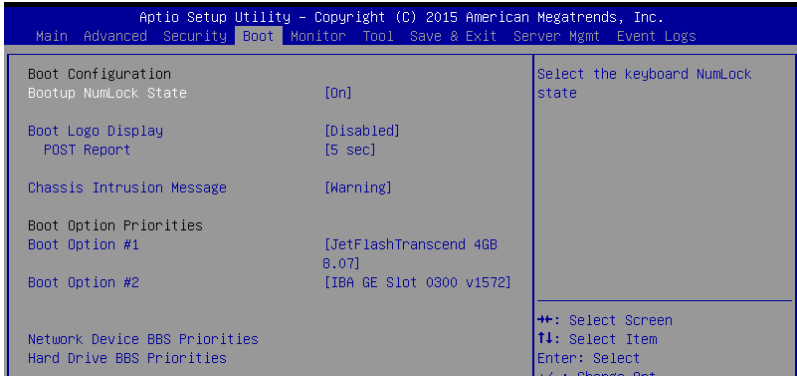

Bootup NumLock State [On]

Allows you to select the power-on state for the NumLock.
Configuration options: [Off] [On]

Boot Logo Display [Disabled]

Allows you to enable or disable the full screen logo display feature.

- [Auto] Auto adjustment for Windows requirements.
- [Full Screen] Maximize the boot logo size.
- [Disabled] Hide the logo during POST.

POST Report [5 sec]

Allows you to set the desired POST Report waiting time from 1 to 10 seconds.
Configuration options: [1 sec] – [10 sec] [Until Press ESC]

Chassis Intrusion Message [Warning]

Allows you to set an action when chassis intrusion has occurred.

- [Warning] Warning beep and pause at intrusion message for 3 seconds.
- [Halt] Halt at intrusion message.

Boot Option Priorities

These items specify the boot device priority sequence from the available devices. The number of device items that appears on the screen depends on the number of devices installed in the system.



- To select the boot device during system startup, press <F8> when ASUS Logo appears.
- To access Windows OS in Safe Mode, please press <F8> after POST.

Set the booting order of network devices.

Boot Option #1 [IBA GE Slot 0300 v1572]

Configuration options: [IBA GE Slot 0300 v1572] [Disabled]

Network Device BBS Priorities

This item allows you to set the booting from network.

Hard Drive BBS Priorities

These items appear only when you connect SATA ODD or hard drive to the SATA ports and allow you to set the booting order of the SATA devices.

4.7 Monitor Menu

The Monitor menu displays the system temperature/power status, and allows you to change the fan settings.

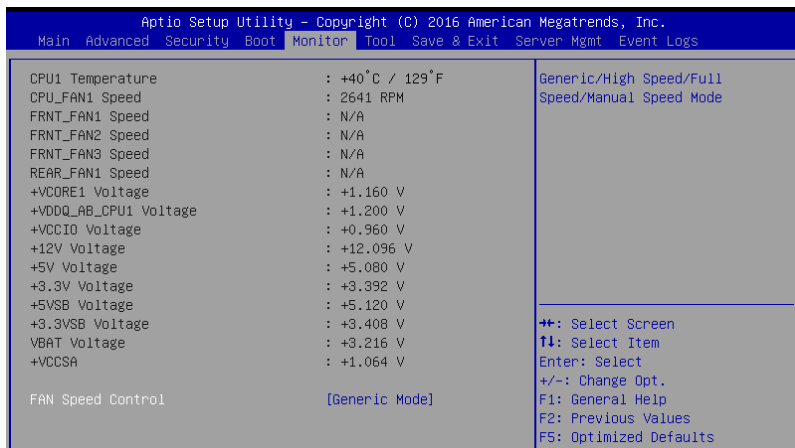

Fan Speed Control [Generic Mode]

Allows you to set the fan speed.

Configuration options: [Generic Mode] [High Speed Mode] [Full Speed Mode] [Manual Speed Mode]

4.8 Tool menu

The Tool menu items allow you to configure options for special functions. Select an item then press <Enter> to display the submenu.

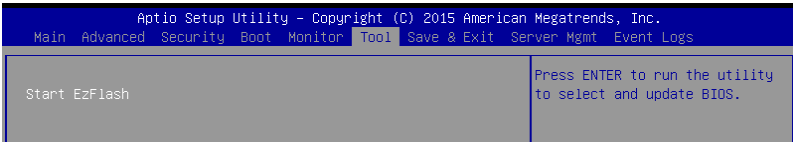

Start EzFlash

Allows you to run ASUS EZ Flash BIOS ROM Utility when you press <Enter>. Refer to the **ASUS EzFlash Utility** section for details.

4.9 Save & Exit menu

The Exit menu items allow you to save or discard your changes to the BIOS items.

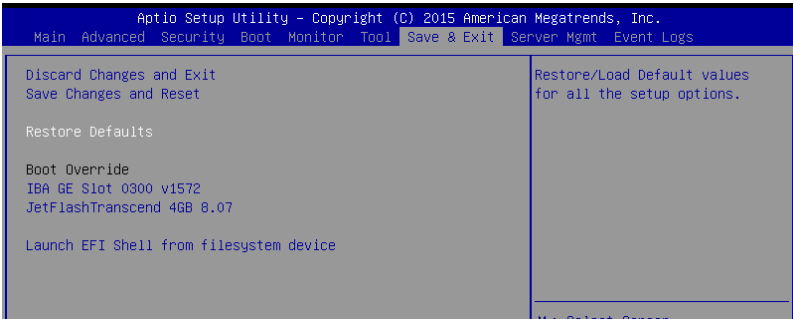

Pressing <Esc> does not immediately exit this menu. Select one of the options from this menu or <F10> from the legend bar to exit.

Discard Changes and Exit

Exit System setup without saving any changes.

Save Changes and Reset

Reset the system setup after saving the changes.

Restore Defaults

Restore/load default values for all the setup options.

Boot Override

These items displays the available devices. The device items that appears on the screen depends on the number of devices installed in the system. Click an item to start booting from the selected device.

Launch EFI Shell from filesystem device

Attempts to launch EFI Shell application (Shell.efi) from one of the available filesystem devices.

4.10 Server Mgmt menu

The Server Management menu displays the server management status and allows you to change the settings.

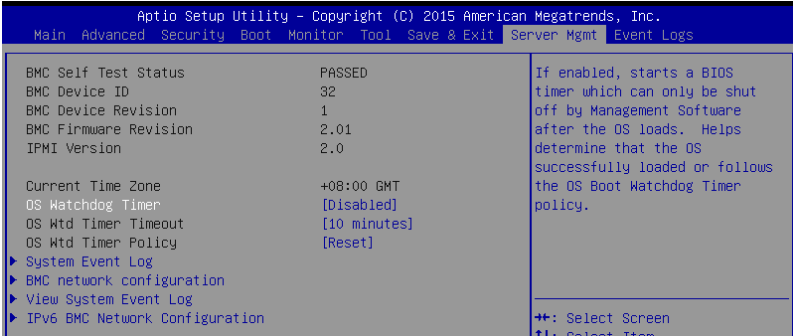

OS Watchdog Timer [Disabled]

This item allows you to start a BIOS timer which can only be shut off by Management Software after the OS loads.

Configuration options: [Enabled] [Disabled]



The following items is configurable only when the **OS Watchdog Timer** is set to **[Enabled]**.

OS Wtd Timer Timeout [10 minutes]

Allows you to configure the length for the OS Boot Watchdog Timer.

Configuration options: [5 minutes] [10 minutes] [15 minutes] [20 minutes]

OS Wtd Timer Policy [Reset]

This item allows you to configure how the system should respond if the OS Boot Watchdog Timer expires.

Configuration options: [Do Nothing] [Reset] [Power Down] [Power Cycle]

System Event Log

Allows you to change the System Event Log configuration.

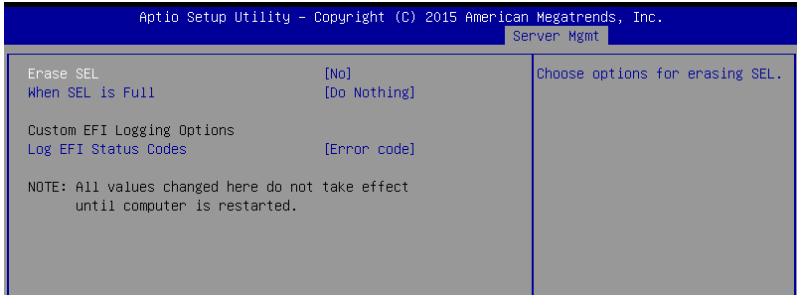

All values changed here do not take effect until computer is restarted.

Erase SEL [No]

Allows you to choose options for erasing SEL.

Configuration options: [No] [Yes, On next reset] [Yes, On every reset]

When SEL is Full [Do Nothing]

Allows you to choose options for reactions to a full SEL.

Configuration options: [Do Nothing] [Erase Immediately]

Log EFI Status Codes [Error code]

Disable the logging of EFI Status Codes, or log only error code, or only progress code, or both.

Configuration options: [Disabled] [Both] [Error code] [Progress code]

BMC network configuration

The sub-items in this configuration allow you to configure the BMC network parameters.

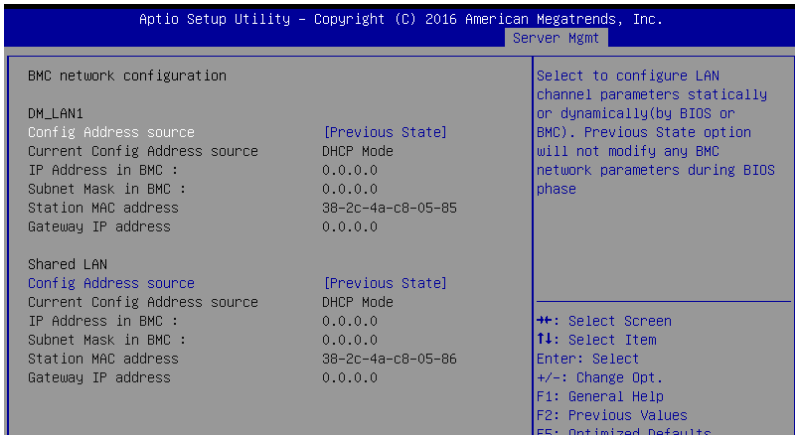

DM_LAN1 / Shared LAN

Config Address source [Previous State]

This item allows you to configure LAN channel parameters statistically or dynamically (by BIOS or BMC). Previous State option will not modify any BMC network parameters during BIOS phase.

Configuration options: [Previous State] [Static] [DynamicBmcDhcp]

View System Event Log

This item allows you to view the System Event Log Records.

IPv6 BMC Network Configuration

This item allows you to configure the parameter settings of IPv6 BMC network.

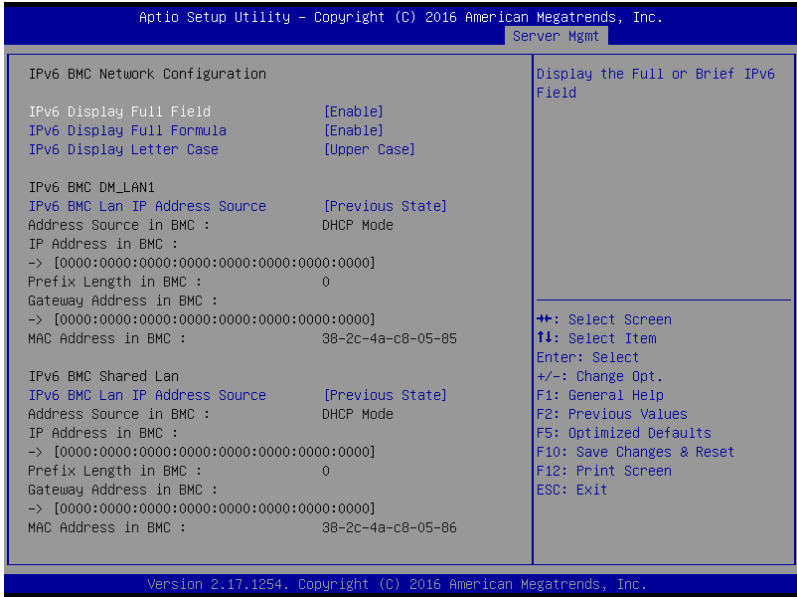

IPv6 Display Full Field [Enable]

Displays the Full or Brief IPv6 Field.
Configuration options: [Disable] [Enable]

IPv6 Display Full Formula [Enable]

Displays the Full or Brief IPv6 Formula.
Configuration options: [Disable] [Enable]

IPv6 Display Letter Case [Upper Case]

Displays the uppercase or lowercase letters of the alphabet.
Configuration options: [Lower Case] [Upper Case]

IPv6 BMC DM_LAN1 / Shared LAN

IPv6 BMC LAN IP Address source [Previous State]

Select to configure LAN channel parameters statically or dynamically (by BIOS or BMC).
Configuration options: [Previous State] [Static] [Dynamic-Obtained by BMC running DHCP]

4.11 Event Logs menu

The Event Logs menu items allow you to change the event log settings and view the system event logs.

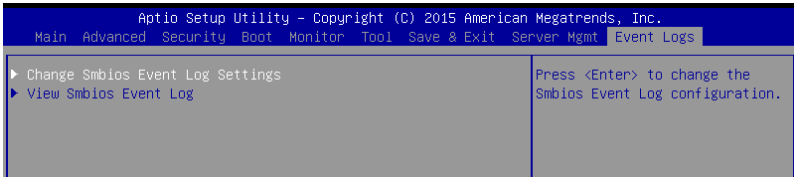

4.11.1 Change Smbios Event Log Settings

Press <Enter> to change the Smbios Event Log configuration.

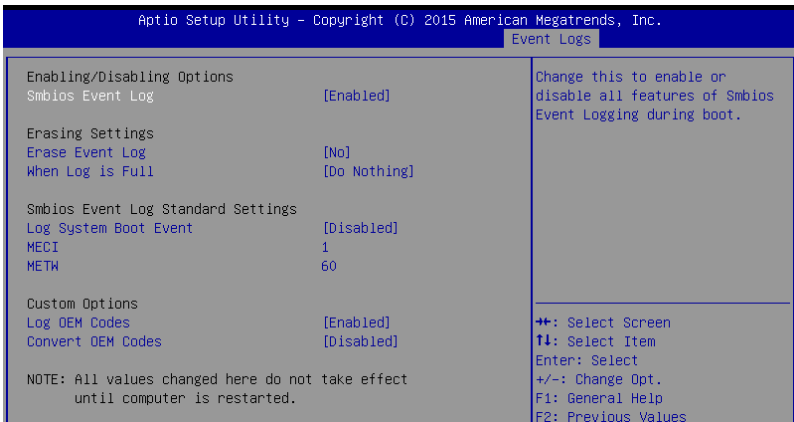

Enabling/Disabling Options

Smbios Event Log [Enabled]

Change this to enable or disable all features of Smbios Event Logging during boot.

Configuration options: [Disabled] [Enabled]



- The following items appears only when you set **Smbios Event Log** to [Enabled].
- All values changed here do not take effect until computer is restarted.

Erasing Settings

Erase Event Log [No]

Choose options for erasing Smbios Event Log. Erasing is done prior to any logging activation during reset.

Configuration options: [No] [Yes, Next reset] [Yes, Every reset]

When Log is Full [Do Nothing]

Allows you to choose options for reactions to a full Smbios Event Log.

Configuration options: [Do Nothing] [Erase Immediately]

Smbios Event Log Standard Settings

Log System Boot Event [Disabled]

Allows you to enable or disable logging of System boot event.

Configuration options: [Enabled] [Disabled]

MECI [1]

Also known as Multiple Event Count Increment, and allows you to set the value for the number of occurrences of a duplicate event that must pass before the multiple-event counter of log entry is updated. Use the <+> and <-> keys to adjust the value.

Configuration options: [1] - [255]

METW [60]

Also known as Multiple Time Event Window, and allows you to set the value for the number of minutes which must pass between duplicate log entries which utilize a multiple-event counter. Use the <+> and <-> keys to adjust the value.

Configuration options: [0] - [99]

Custom Options

Log OEM Codes [Enabled]

Allows you to enable or disable the logging of EFI Status Codes as OEM codes (if not already converted to legacy).

Configuration options: [Disabled] [Enabled]

Convert OEM Codes [Disabled]

Allows you to enable or disable the converting of EFI Status Codes to Standard Smbios Types (not all may be translated).

Configuration options: [Disabled] [Enabled]

Chapter 5: RAID Configuration

5.1 Setting up RAID

The motherboard comes with the Intel® C232 controller that supports **Intel® Rapid Storage Technology enterprise Option ROM Utility** with RAID 0, RAID 1, RAID 10, and RAID 5 support (for both Windows® OS and Linux).

5.1.1 RAID definitions

RAID 0 (*Data striping*) optimizes two identical hard disk drives to read and write data in parallel, interleaved stacks. Two hard disks perform the same work as a single drive but at a sustained data transfer rate, double that of a single disk alone, thus improving data access and storage. Use of two new identical hard disk drives is required for this setup.

RAID 1 (*Data mirroring*) copies and maintains an identical image of data from one drive to a second drive. If one drive fails, the disk array management software directs all applications to the surviving drive as it contains a complete copy of the data in the other drive. This RAID configuration provides data protection and increases fault tolerance to the entire system. Use two new drives or use an existing drive and a new drive for this setup. The new drive must be of the same size or larger than the existing drive.

RAID 10 is data striping and data mirroring combined without parity (redundancy data) having to be calculated and written. With the RAID 10 configuration you get all the benefits of both RAID 0 and RAID 1 configurations. Use four new hard disk drives or use an existing drive and three new drives for this setup.

RAID 5 stripes both data and parity information across three or more hard disk drives. Among the advantages of RAID 5 configuration include better HDD performance, fault tolerance, and higher storage capacity. The RAID 5 configuration is best suited for transaction processing, relational database applications, enterprise resource planning, and other business systems. Use a minimum of three identical hard disk drives for this setup.



If you want to boot the system from a hard disk drive included in a created RAID set, copy first the RAID driver from the support DVD to a floppy disk before you install an operating system to the selected hard disk drive.

5.1.2 Installing hard disk drives

The motherboard supports Serial ATA for RAID set configuration. For optimal performance, install identical drives of the same model and capacity when creating a disk array.

To install the SATA hard disks for RAID configuration:

1. Install the SATA hard disks into the drive bays following the instructions in the system user guide.
2. Connect a SATA signal cable to the signal connector at the back of each drive and to the SATA connector on the motherboard.
3. Connect a SATA power cable to the power connector on each drive.

5.1.3 Setting the RAID mode in BIOS

You must set the RAID mode in the BIOS Setup to be able to launch the RAID utilities before you can create a RAID set from the SATA hard disk drives attached to the SATA connectors supported by Intel® C232 chipset.

To do this:

1. Enter the BIOS Setup during POST.
2. Go to the **Advanced Menu > SATA Configuration**, then press <Enter>.
3. Set **SATA Mode** to [RAID].
4. Press <F10> to save your changes and exit the BIOS Setup.



Refer to **Chapter 4** for details on entering and navigating through the BIOS Setup.

5.1.4 RAID configuration utilities

Depending on the RAID connectors that you use, you can create a RAID set using the utilities embedded in each RAID controller. For example, use the **Intel® Rapid Storage Technology enterprise SATA Option ROM Utility** if you installed Serial ATA hard disk drives on the Serial ATA connectors supported by the Intel® C232 chipset.

5.2 Intel® Rapid Storage Technology enterprise SATA Option ROM Utility

The Intel® Rapid Storage Technology enterprise SATA Option ROM utility allows you to create RAID 0, RAID 1, RAID 10 (RAID 1+0), and RAID 5 set from Serial ATA hard disk drives that are connected to the Serial ATA connectors supported by the Southbridge.



Before you proceed, ensure that you have installed the Serial ATA hard disk drives, and have set the correct SATA mode in the BIOS setup. You can refer to sections **5.1.2 Installing hard disk drives** and **5.1.3 Setting the RAID mode in BIOS** for more information.

To launch the Intel® Rapid Storage Technology enterprise SATA Option ROM utility:

1. Turn on the system.
2. During POST, press <Ctrl>+<I> to display the utility main menu.

```
Intel(R) Rapid Storage Technology enterprise - SATA Option ROM - 4.5.0.1012
Copyright (C) 2003-15 Intel Corporation. All Rights Reserved.

[ MAIN MENU ]
1. Create RAID Volume
2. Delete RAID Volume
3. Reset Disks to Non-RAID
4. Mark Disks as Spare
5. Exit

[ DISK/VOLUME INFORMATION ]

RAID Volumes:
None defined.

Physical Disks:
ID Drive Model Serial # Size Type/Status (Vol ID)
0 ST3300656SS HWA50000991753TR 279.3GB Non-RAID Disk
1 ST3300656SS 37VN00009846RAJ1 279.3GB Non-RAID Disk
2 ST3300656SS 397600009846UEDY 279.3GB Non-RAID Disk
3 ST3300656SS GWC50000991756G6 279.3GB Non-RAID Disk

[↑↓]-Select [ESC]-Exit [ENTER]-Select Menu
```

The navigation keys at the bottom of the screen allow you to move through the menus and select the menu options.



The RAID BIOS setup screens shown in this section are for reference only and may not exactly match the items on your screen.

5.2.1 Creating a RAID set

To create a RAID set:

1. From the utility main menu, select **1. Create RAID Volume** and press <Enter>.
2. Key in a name for the RAID set and press <Enter>.

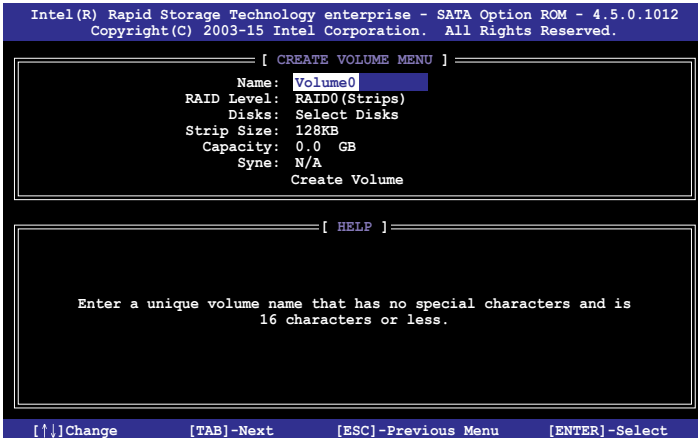

3. Press the up/down arrow keys to select a RAID Level that you wish to create then press <Enter>.
4. From the **Disks** item field, press <Enter> to select the hard disk drives that you want to include in the RAID set.

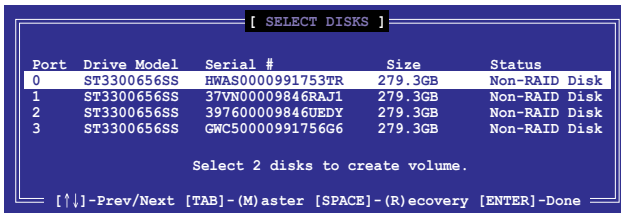

5. Use the up/down arrow keys to move the selection bar then press <Space> to select a disk. A small triangle before the Port number marks the selected drive. Press <Enter> when you are done.

6. Use the up/down arrow keys to select the stripe size for the RAID array (for RAID 0, 10 and 5 only) then press <Enter>. The available stripe size values range from 4 KB to 128 KB. The following are typical values:
RAID 0: 128KB
RAID 10: 64KB
RAID 5: 64KB



We recommend a lower stripe size for server systems, and a higher stripe size for multimedia computer systems used mainly for audio and video editing.

7. In the **Capacity** field item, key in the RAID volume capacity that you want to use and press <Enter>. The default value field indicates the maximum allowed capacity.
8. Press <Enter> to start creating the RAID volume.
9. From the following warning message, press <Y> to create the RAID volume and return to the main menu, or press <N> to go back to the **CREATE VOLUME** menu.

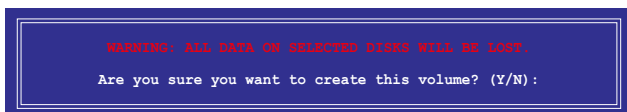

5.2.2 Deleting a RAID set



Take caution when deleting a RAID set. You will lose all data on the hard disk drives when you delete a RAID set.

To delete a RAID set:

1. From the utility main menu, select **2. Delete RAID Volume** and press <Enter>.
2. From the Delete Volume Menu, press the up/down arrow keys to select the RAID set you want to delete then press .

```
Intel(R) Rapid Storage Technology enterprise - SATA Option ROM - 4.5.0.1012
Copyright(C) 2003-15 Intel Corporation. All Rights Reserved.

[ DELETE VOLUME MENU ]

Name      Level      Drives    Capacity   Status    Bootable
Volume0   RAID0(Stripe)  2         298.0GB   Normal    Yes

[ HELP ]

Deleting a volume will reset the disks to non-RAID
WARNING: ALL DISK DATA WILL BE DELETED.
(This does not apply to Recovery volumes)

[↑,↓]-Select      [ESC]-Previous Menu      [DEL]-Delete Volume
```

3. Press <Y> to confirm deletion of the selected RAID set and return to the utility main menu, or press <N> to return to the **DELETE VOLUME** menu.

```
[ DELETE VOLUME VERIFICATION ]

ALL DATA IN THE VOLUME WILL BE LOST!
(This does not apply to Recovery volumes)

Are you sure you want to delete volume "Volume0"? (Y/N):
```

5.2.3 Resetting disks to Non-RAID



Take caution before you reset a RAID volume hard disk drive to non-RAID. Resetting a RAID volume hard disk drive deletes all internal RAID structure on the drive.

To reset a RAID set:

1. From the utility main menu, select **3. Reset Disks to Non-RAID** and press <Enter>.
2. Press the up/down arrow keys to select the drive(s) or disks of the RAID set you want to reset, then press <Space>. A small triangle before the Port number marks the selected drive. Press <Enter> when you are done.

```
[ RESET RAID DATA ]
Resetting RAID disk will remove its RAID structures
and revert it to a non-RAID disk.

WARNING: Resetting a disk causes all data on the disk to be lost.
(This does not apply to Recovery volumes)

Port  Drive Model  Serial #      Size      Status
---  -
0     ST3300656SS   HWAS0000991753TR  279.3GB  Member Disk
1     ST3300656SS   37VN00009846RAJL  279.3GB  Member Disk

Select the disks that should be reset.

[↑↓]-Previous/Next [SPACE]-Selects [ENTER]-Selection Complete
```

3. Press <Y> in the confirmation window to reset the drive(s) or press <N> to return to the utility main menu.

5.2.4 Exiting the Intel® Rapid Storage Technology enterprise SATA Option ROM utility

To exit the utility:

1. From the utility main menu, select **4. Exit** then press <Enter>.
2. Press <Y> to exit or press <N> to return to the utility main menu.

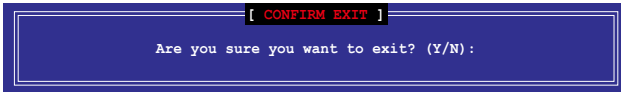

5.2.5 Rebuilding the RAID



This option is only for the RAID 1 set.

Rebuilding the RAID with other non-RAID disk

If any of the SATA hard disk drives included in the RAID 1 array failed, the system displays the status of the RAID volume as **"Degraded"** during POST. You can rebuild the RAID array with other installed non-RAID disks.

To rebuild the RAID with other non-RAID disk:

1. During POST, press <Ctrl>+<I> at the prompt to enter the Intel Rapid Storage Technology option ROM utility.
2. If there is a non-RAID SATA Hard Disk available, the utility will prompt you to rebuild the RAID. Press the up/down arrow keys to select the destination disk then Press <Enter> to start the rebuilding process, or press <ESC> to exit.

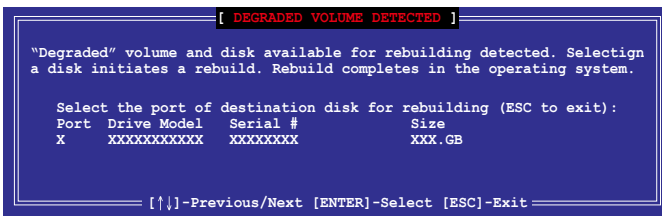

Select a destination disk with the same size as the original hard disk.

- The utility immediately starts rebuilding after the disk is selected. When done, the status of the degraded RAID volume is changed to **“Rebuild”**.

```

Intel(R) Rapid Storage Technology enterprise - SATA Option ROM - 4.5.0.1012
Copyright (C) 2003-15 Intel Corporation. All Rights Reserved.

[ MAIN MENU ]
1. Create RAID Volume
2. Delete RAID Volume
3. Reset Disks to Non-RAID
4. Mark Disks as Spare
5. Exit

[ DISK/VOLUME INFORMATION ]

RAID Volumes:
ID   Name      Levell      Strip      Size      *Data is Encrypted
1    Volume0   RAID1 (Mirror)  N/A       149.0GB   Status      Bootable
                                     Rebuild    Yes

Physical Devices:
Port  Drive Model  Serial #      Size      Type/Status (Vol ID)
1     ST3160812AS  9LS0F4HL     149.0GB  Member Disk(0)
2     ST3160812AS  3LS0JYL8     149.0GB  Member Disk(0)

Volumes with "Rebuild" status will be rebuilt within the operating system.

[↑↓]-Select      [ESC]-Exit      [ENTER]-Select Menu

```

- Press <Esc> to exit Intel Rapid Storage Technology and reboot the system.
- Select **Start > Programs > Intel Rapid Storage > Intel Rapid Storage Console** or click the **Intel Rapid Storage Technology** tray icon to load the Intel Rapid Storage Manager utility.
- From the **View** menu, select **Advanced Mode** to display the details of the Intel Rapid Storage Console.
- From the **Volumes view** option, select **RAID volume** to view the rebuilding status. When finished, the status is changed to **“Normal”**.

Rebuilding the RAID with a new hard disk

If any of the SATA hard disk drives included in the RAID array failed, the system displays the status of the RAID volume as **“Degraded”** during POST. You may replace the disk drive and rebuild the RAID array.

To rebuild the RAID with a new hard disk:

- Remove the failed SATA hard disk and install a new SATA hard disk of the same specification into the same SATA Port.



Select a destination disk with the same size as the original hard disk.

- Reboot the system then follow the steps in section **Rebuilding the RAID with other non-RAID disk**.

5.2.6 Setting the Boot array in the BIOS Setup Utility

You can set the boot priority sequence in the BIOS for your RAID arrays when creating multi-RAID using the Intel® Rapid Storage Technology enterprise SATA Option ROM utility.

To set the boot array in the BIOS:



Set at least one of the arrays bootable to boot from the hard disk.

1. Reboot the system and press to enter the BIOS setup utility during POST.
2. Go to the **Boot** menu and select the boot option priority.
3. Use up/down arrow keys to select the boot priority and press <Enter>. See the **Boot menu** section of Chapter 4 for more details.
4. From the **Exit** menu, select **Save Changes & Exit**, then press <Enter>.
5. When the confirmation window appears, select **Yes**, then press <Enter>.

5.3 Intel® Rapid Storage Technology enterprise (Windows)

The Intel® Rapid Storage Technology enterprise allows you to create RAID 0, RAID 1, RAID 10 (RAID 1+0), and RAID 5 set(s) from Serial ATA hard disk drives that are connected to the Serial ATA connectors supported by the Southbridge.



You need to manually install the Intel® Rapid Storage Technology enterprise utility on a Windows® operating system. Please refer to the installation instructions in **Chapter 6**.

To enter the Intel® Rapid Storage Technology enterprise utility under Windows operating system:

1. Turn on the system to windows desktop.
2. Click the **Intel® Rapid Storage Technology enterprise** icon to display the main menu.

Your storage system is configured for data protection, increased performance and optimal data storage capacity. You can create additional volumes to further optimize your storage system.

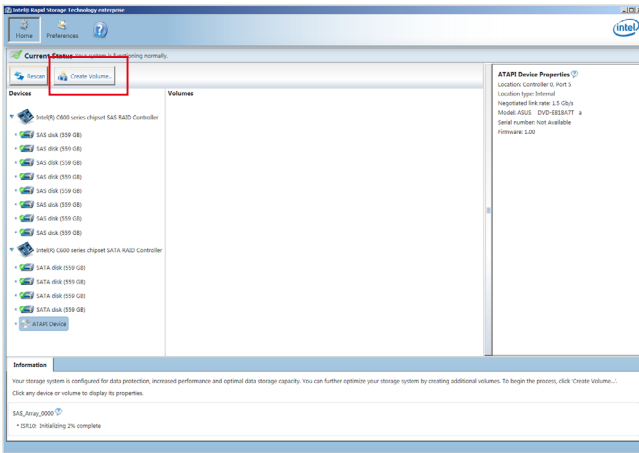

You can click **Rescan** to re-scan any attached hard disks.

5.3.1 Creating a RAID set

To create a RAID set:

1. From the utility main menu, select **Create Volume** then select volume type and click **Next**.

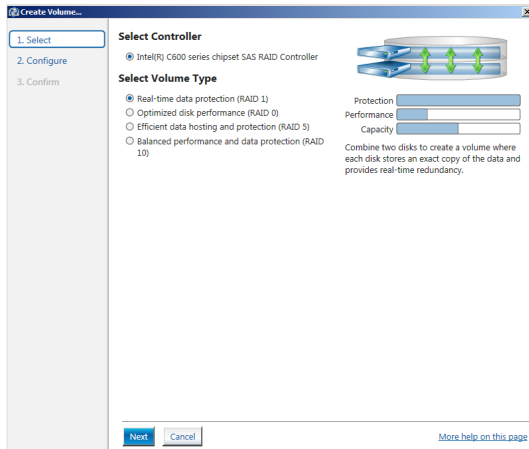

2. Key in a name for the RAID set, then select the array disks.
3. Select the **Volume Size** tab then drag the bar to set the volume size.
4. Click **Next**.

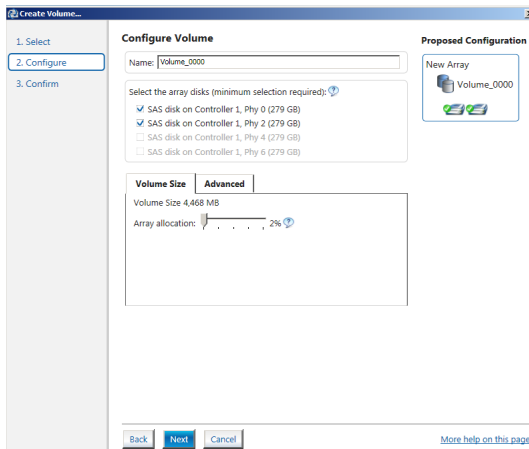

- If you do not want to keep the data on one of the selected disks, select **NO** when prompted.
- If you want to **Enable volume write-back cache** or **Initialize volume**, click **Advanced**.

5. Confirm the volume creation, then click **Create Volume** to continue.



This process could take a while depending on the number and size of the disks. You can continue using other applications during this time.

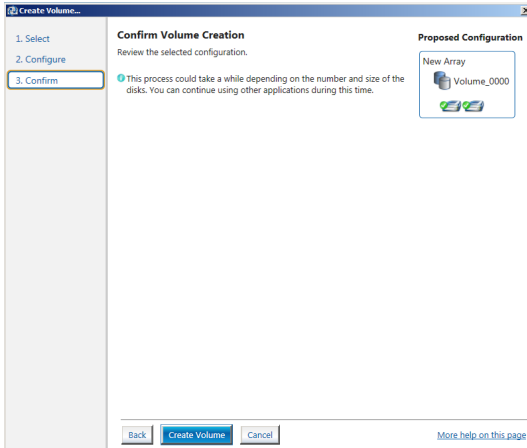

6. Wait until the process is completed, then click **OK** when prompted.

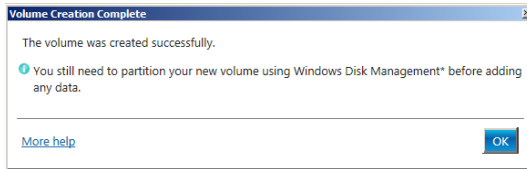

You still need to partition your new volume using Windows Disk Management before adding any data.

The created RAID set is displayed in the **Volumes** list. If you wish to change the settings, go to **Volume Properties**.

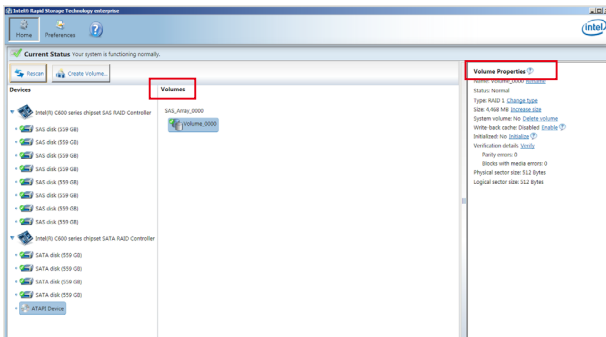

5.3.2 Changing a Volume Type

To change the volume type in **Volume Properties**:

1. Click the SATA array items you want to change in **Volumes** field.
2. From the **Volume Properties** field, select **Type: RAID 1 Change type**.

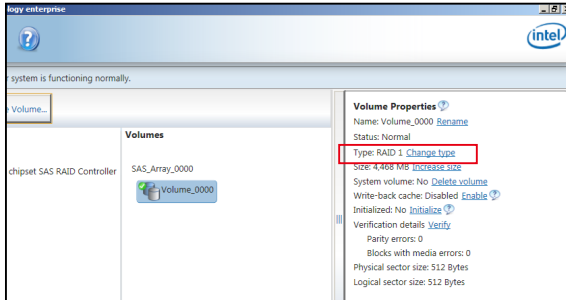

3. You can also change the **Name**, **Select the new volume type**, and **Select additional disks to include in the new volume** if needed.
4. Select the **Data stripe size** for the RAID array (for RAID 0, 10 and 5 only) and click **OK**. The available stripe size values range from 4 KB to 128 KB. The following are typical values:
RAID 0: 128KB
RAID 10: 64KB
RAID 5: 64KB

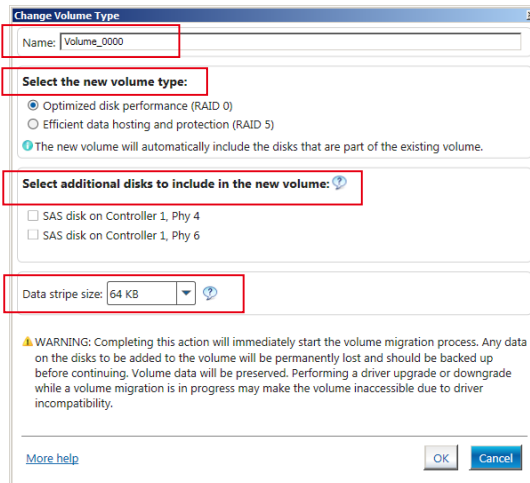

We recommend a lower stripe size for server systems, and a higher stripe size for multimedia computer systems used mainly for audio and video editing.

5.3.3 Deleting a volume



Be cautious when deleting a volume. You will lose all data on the hard disk drives. Before you proceed, ensure that you back up all your important data from your hard drives.

To delete a volume:

1. From the **Volumes** field in the utility main menu, select the volume that you want to delete.

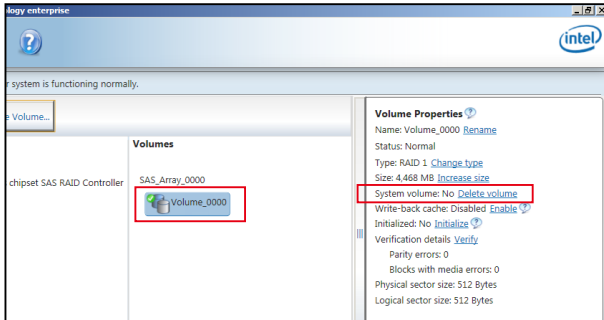

2. From the **Volume Properties** field, select **Delete volume**.
3. Click **Yes** to delete the volume and return to the utility main menu, or click **No** to return to the main menu.

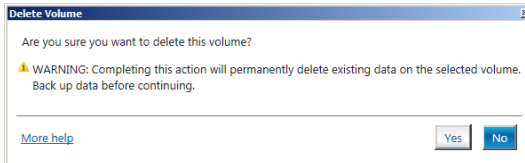

5.3.4 Preferences

System Preferences

Allow you to set to show the notification area icon and show system information, warning, or errors here.

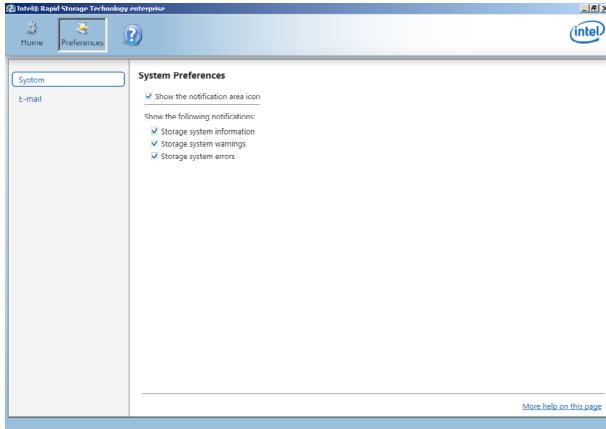

E-Mail Preferences

Allow you to set to sent e-mail of the following events:

- Storage system information
- Storage system warnings
- Storage system errors

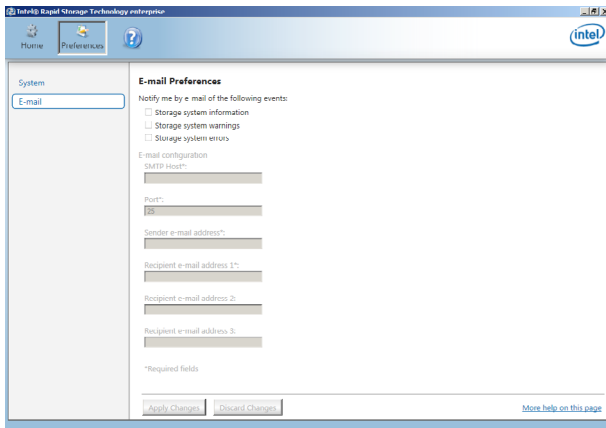

Chapter 6: Driver Installation

6.1 RAID driver installation

After creating the RAID sets for your server system, you are now ready to install an operating system to the independent hard disk drive or bootable array. This part provides the instructions on how to install the RAID controller drivers during OS installation.

6.1.1 Creating a USB flash drive with RAID driver

When installing Windows® Server OS, you can load the RAID driver from a USB flash drive. You can create a USB flash drive with RAID driver in Windows by copying the files from the support DVD to the USB flash drive.

To copy the RAID driver to a USB flash drive in Windows environment:

1. Place the motherboard support DVD in the optical drive.
2. Connect a USB flash drive to your system.
3. Click on the optical drive to browse the contents of the support DVD.
4. Click **Drivers > C23x INTEL RAID > Driver > Windows** and then copy the **SATA_RAID** driver folder to the USB flash drive.

6.1.2 Installing the RAID controller driver

During Windows® Server 2008 OS installation

To install the RAID controller driver when installing Windows® Server 2008 OS

1. Boot the computer using the Windows® Server 2008 OS installation disc. Follow the screen instructions to start installing Windows Server 2008.
2. When prompted to choose a type of installation, click **Custom (advanced)**.

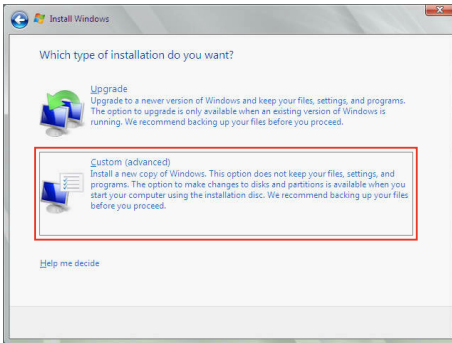

3. Click **Load Driver**.

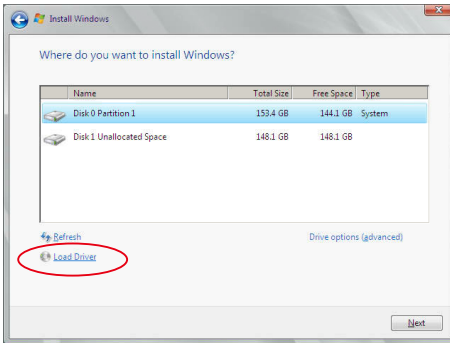

4. A message appears reminding you to insert the installation media containing the driver of the RAID controller driver (the installation media can be a CD, DVD, or USB flash drive).
- If you have only one optical drive installed in your system, eject the Windows OS installation disc and replace with the motherboard Support DVD into the optical drive.
 - Or you may connect a USB flash drive containing the RAID controller driver.

Click **Browse** to continue.



5. Locate the driver in the corresponding folder of the Support DVD or USB flash drive and then click **OK** to continue.
6. Select the RAID controller driver you need from the list and click **Next**.

7. When the system finishes loading the RAID driver,
 - Replace the motherboard Support DVD with the Windows Server installation disc.
 - Remove the USB flash drive.

Select the drive to install Windows and click Next.

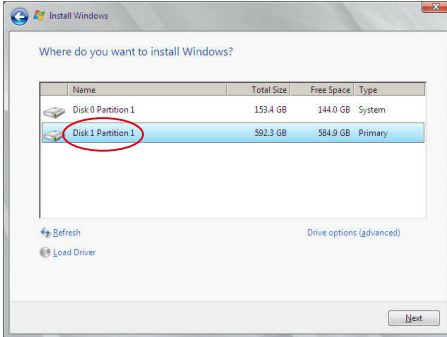

8. Follow succeeding screen instructions to continue.

6.2 Management applications and utilities installation

The support DVD that is bundled with your motherboard contains drivers, management applications, and utilities that you can install to maximize the features of your motherboard.



-
- The contents of the support DVD are subject to change at any time without notice. Visit the ASUS website (www.asus.com) for the latest updates on software and utilities.
 - The support DVD is supported on Windows® Server 2008 R2 and Windows® Server 2012.
-

6.3 Running the Support DVD

When you place the support DVD into the optical drive, the DVD automatically displays the main screen if Autorun is enabled in your computer. By default, the Drivers tab is displayed.



If Autorun is NOT enabled in your computer, browse the contents of the support DVD to locate the file **ASSETUP.EXE** from the **BIN** folder. Double-click the **ASSETUP.EXE** to run the support DVD.

The main screen of the Support DVD contains the following tabs:

1. Drivers
2. Utilities
3. Manual
4. Contact



The main screen of the Support DVD looks exactly the same on the Windows® Server 2008 R2 and on the Windows® Server 2012 Operating System (OS).

6.3.1 Drivers menu tab

The Drivers Menu shows the available device drivers if the system detects installed devices. Install the necessary drivers to activate the devices.

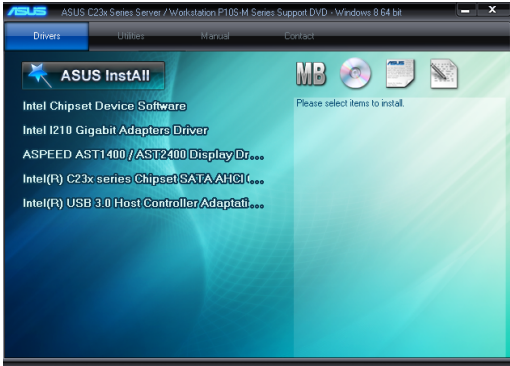

6.3.2 Utilities menu tab

The Utilities menu displays the software applications and utilities that the motherboard supports.



6.3.3 Manual menu

The Manual menu provides the link to the P10S-M user guide.



You need an internet browser installed in your OS to view the User Guide.



6.3.4 Contact information menu

The Contact menu displays the ASUS contact information, e-mail addresses, and useful links if you need more information or technical support for your motherboard.



6.4 Installing the Intel® Chipset device Software driver

This section provides the instructions on how to install the Intel® chipset device software on the system.

You need to manually install the Intel® chipset device software on a Windows® Operating System.

To install the Intel® chipset device software:

1. Restart the computer.
2. Log in with **Administrator** privileges.
3. Insert the Motherboard Support DVD to the optical drive.

The support DVD automatically displays the **Drivers** menu if Autorun is enabled in your computer.



If Autorun is NOT enabled in your computer, browse the contents of the support DVD to locate the file **ASSETUP.EXE** from the **BIN** folder. Double-click the **ASSETUP.EXE** to run the support DVD.

4. Click **Intel® Chipset Device Software** from the Drivers menu to start the installation.
5. The **Intel(R) Chipset Device Software** window appears. Click **Next** to start installation.

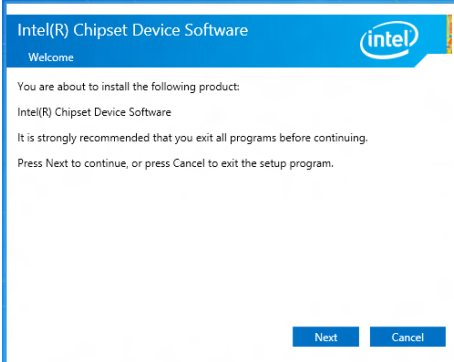

6. Select **Yes** to accept the terms of the **License Agreement** and continue the process.

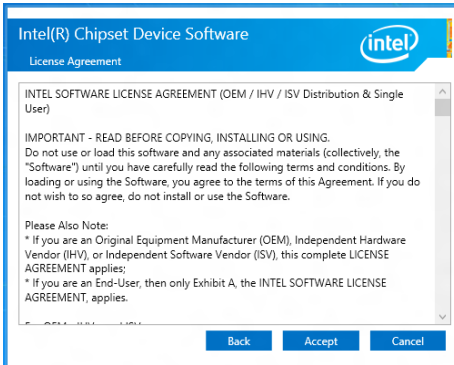

7. Read the **Readme File Information** and press **Next** to continue the installation.

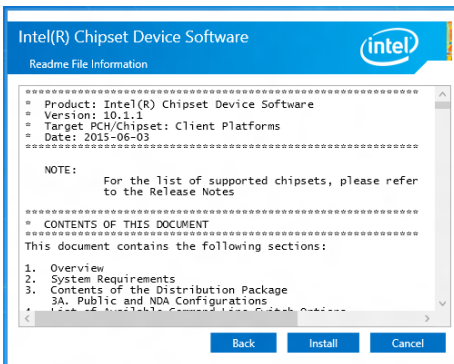

8. Toggle **Yes, I want to restart the computer now** and click **Finish** to complete the setup process.

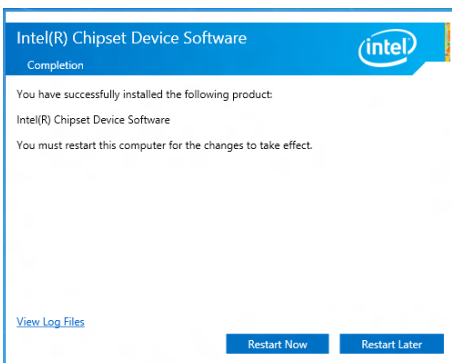

6.5 Installing the Intel® I210 Gigabit Adapters driver

This section provides the instructions on how to install the **Intel® I210 Gigabit Adapter Driver** on the system.

To install the **Intel® I210 Gigabit Adapters Driver** on the Windows® operating system:

1. Restart the computer.
2. Log on with **Administrator** privileges.
3. Insert the motherboard/system support DVD to the optical drive.



If Autorun is NOT enabled in your computer, browse the contents of the support DVD to locate the file **ASSETUP.EXE** from the **BIN** folder. Double-click the **ASSETUP.EXE** to run the support DVD.

4. Click **Intel® I210 Gigabit Adapters Drivers** in the **Drivers** menu of the main screen to start the installation.

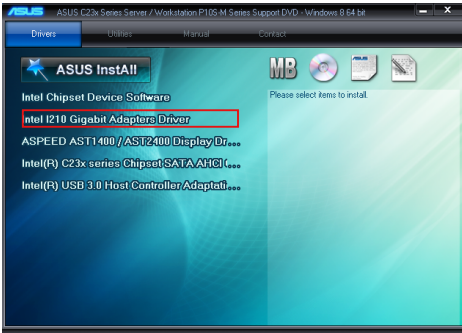

5. Click **Install Drivers and Software** option to begin installation.

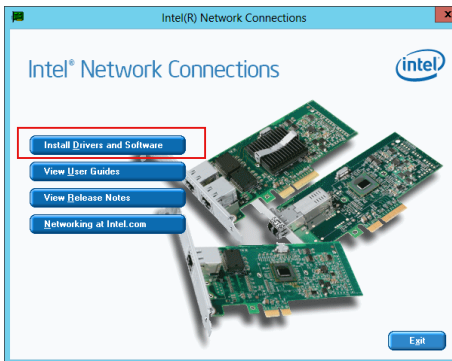

- Click **Next** when the **Intel(R) Network Connections–InstallShield Wizard** window appears.

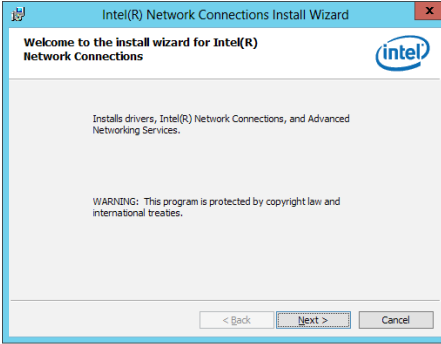

- Tick **I accept the terms in the license agreement** and click **Next** to continue.

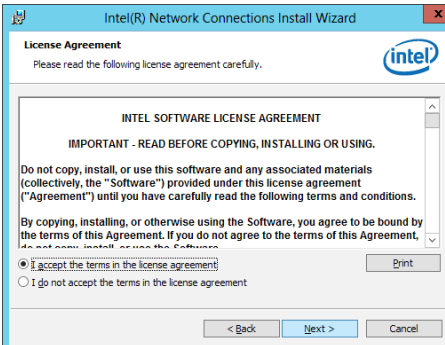

- From the **Setup Options** window, click **Next** to start the installation.



By default, **Intel(R) PROSet for Windows Device Manager** and **Windows PowerShell Module** are ticked.

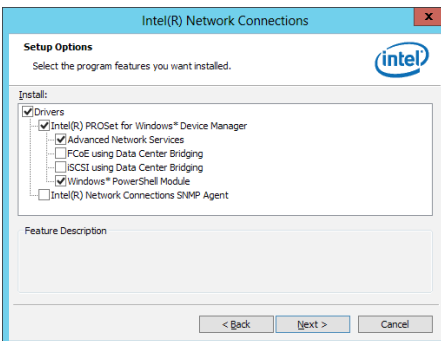

9. Click **Install** to start the installation.

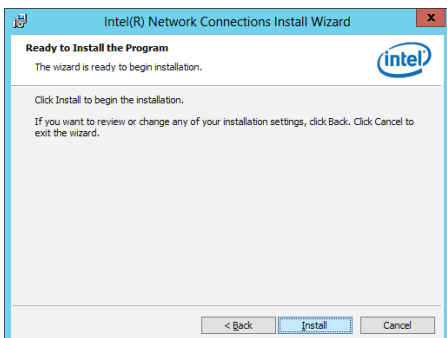

10. When the installation is done, press **Finish** to complete the installation.

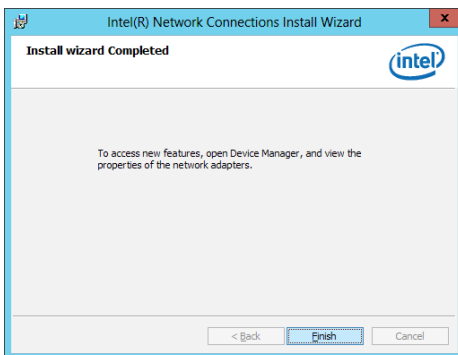

6.6 Installing the VGA driver

This section provides the instructions on how to install the **ASPEED Video Graphics Adapter (VGA)** driver.

To install the **ASPEED VGA** driver:

1. Restart the computer.
2. Log in with **Administrator** privileges.
3. Insert the Motherboard Support DVD to the optical drive.

The support DVD automatically displays the **Drivers** menu if Autorun is enabled in your computer.



If Autorun is NOT enabled in your computer, browse the contents of the support DVD to locate the file **ASSETUP.EXE** from the **BIN** folder. Double-click the **ASSETUP.EXE** to run the support DVD.

4. From the **Main Menu**, click **ASPEED AST1400/AST2400 Display Driver** on the **Drivers** tab to start the installation.

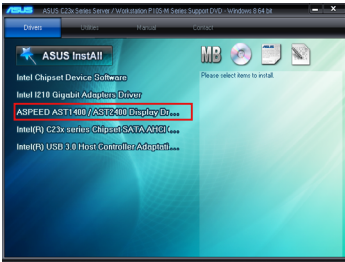

5. From the installation window, click **Next** to start the installation.



6. Click **Install** to proceed with the installation.

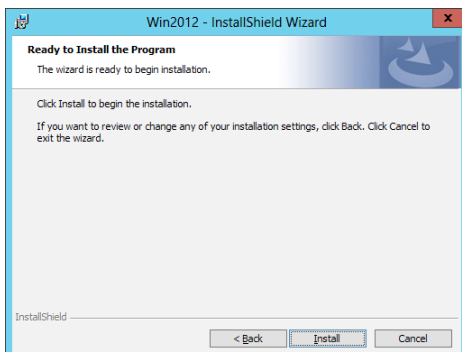

7. Click **Finish** to complete the installation.

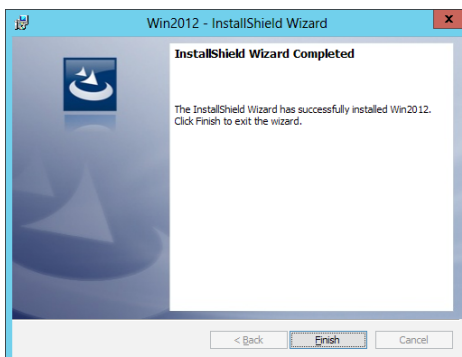

Appendix

P10S-M block diagram

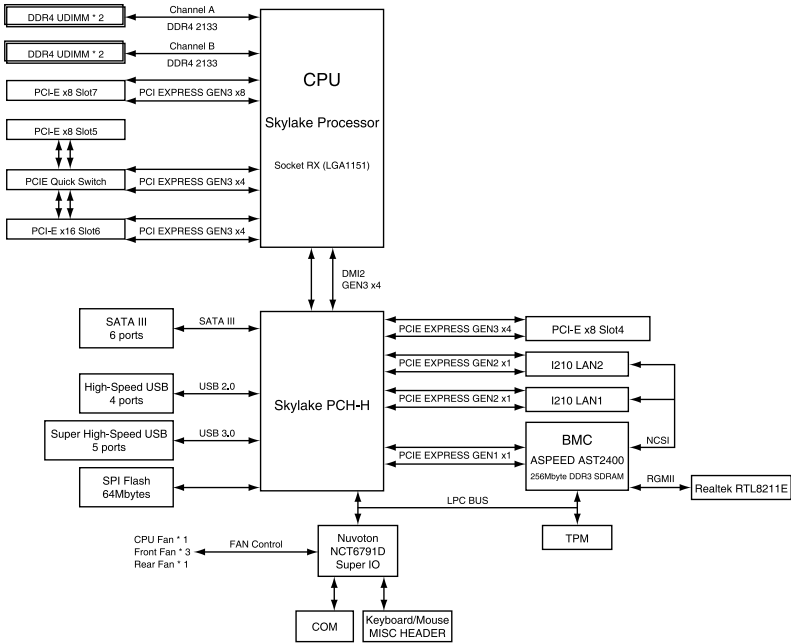

Simplified EU Declaration of Conformity

English ASUSTeK Computer Inc. hereby declares that this device is in compliance with the essential requirements and other relevant provisions of related Directives. Full text of EU declaration of conformity is available at: www.asus.com/support

Français ASUSTeK Computer Inc. déclare par la présente que cet appareil est conforme aux critères essentiels et autres clauses pertinentes des directives concernées. La déclaration de conformité de l'UE peut être téléchargée à partir du site Internet suivant : www.asus.com/support

Deutsch ASUSTeK Computer Inc. erklärt hiermit, dass dieses Gerät mit den wesentlichen Anforderungen und anderen relevanten Bestimmungen der zugehörigen Richtlinien übereinstimmt. Der gesamte Text der EU-Konformitätserklärung ist verfügbar unter: www.asus.com/support

Italiano ASUSTeK Computer Inc. con la presente dichiara che questo dispositivo è conforme ai requisiti essenziali e alle altre disposizioni pertinenti con le direttive correlate. Il testo completo della dichiarazione di conformità UE è disponibile all'indirizzo: www.asus.com/support

Русский Компания ASUS заявляет, что это устройство соответствует основным требованиям и другим соответствующим условиям соответствующих директив. Подробную информацию, пожалуйста, смотрите на www.asus.com/support

Български С настоящото ASUSTeK Computer Inc. декларира, че това устройство е в съответствие със съществените изисквания и другите приложими постановления на свързаните директиви. Пълният текст на декларацията за съответствие на ЕС е достъпен на адрес: www.asus.com/support

Hrvatski ASUSTeK Computer Inc. ovim izjavljuje da je ovaj uređaj sukladan s bitnim zahtjevima i ostalim odgovarajućim odredbama vezanih direktiva. Cijeli tekst EU izjave o sukladnosti dostupan je na: www.asus.com/support

Čeština Společnost ASUSTeK Computer Inc. tímto prohlašuje, že toto zařízení splňuje základní požadavky a další příslušná ustanovení souvisejících směrnic. Plné znění prohlášení o shodě EU je k dispozici na adrese: www.asus.com/support

Dansk ASUSTeK Computer Inc. erklærer hermed, at denne enhed er i overensstemmelse med hovedkravene og andre relevante bestemmelser i de relaterede direktiver. Hele EU-overensstemmelseserklæringen kan findes på: www.asus.com/support

Nederlands ASUSTeK Computer Inc. verklaart hierbij dat dit apparaat voldoet aan de essentiële vereisten en andere relevante bepalingen van de verwante richtlijnen. De volledige tekst van de EU-verklaring van conformiteit is beschikbaar op: www.asus.com/support

Eesti Käesolevaga kinnitab ASUSTeK Computer Inc, et see seade vastab asjakohaste direktiivide olulistele nõuetele ja teistele asjaspuutuvatete sätetele. EL vastavusdeklaratsiooni täielik tekst on saadaval järgmisel aadressil: www.asus.com/support

Suomi ASUSTeK Computer Inc. ilmoittaa täten, että tämä laite on asiaankuuluvien direktiivien olennaisten vaatimusten ja muiden tätä koskevien säädösten mukainen. EU-yhdenmukaisuusilmoituksen koko teksti on luettavissa osoitteessa: www.asus.com/support

Ελληνικά Με το παρόν, η ASUSTeK Computer Inc. δηλώνει ότι αυτή η συσκευή συμμορφώνεται με τις θεμελιώδεις απαιτήσεις και άλλες σχετικές διατάξεις των Οδηγιών της ΕΕ. Το πλήρες κείμενο της δήλωσης συμμορφότητας είναι διαθέσιμο στη διεύθυνση: www.asus.com/support

Magyar Az ASUSTeK Computer Inc. ezennel kijelenti, hogy ez az eszköz megfelel a kapcsolódó irányelvek lényeges követelményeinek és egyéb vonatkozó rendelkezéseinek. Az EU megfeleléségi nyilatkozat teljes szövege innen letölthető: www.asus.com/support

Latviski ASUSTeK Computer Inc. ar šo paziņo, ka šī ierīce atbilst saistīto Direktīvu būtiskajām prasībām un citiem citiem saistošajiem nosacījumiem. Pilns ES atbilstības paziņojuma teksts pieejams šeit: www.asus.com/support

Lietuviai „ASUSTeK Computer Inc.“ šiuo tvirtina, kad šis įrenginys atitinka pagrindinius reikalavimus ir kitas svarbias susijusių direktyvų nuostatas. Visą ES atitikties deklaracijos tekstą galima rasti: www.asus.com/support

Norsk ASUSTeK Computer Inc. erklærer herved at denne enheten er i samsvar med hovedsaklige krav og andre relevante forskrifter i relaterte direktiver. Fullstendig tekst for EU-samsvarserklæringen finnes på: www.asus.com/support

Polski Firma ASUSTeK Computer Inc. niniejszym oświadczam, że urządzenie to jest zgodne z zasadniczymi wymogami i innymi właściwymi postanowieniami powiązanych dyrektyw. Pełny tekst deklaracji zgodności UE jest dostępny pod adresem: www.asus.com/support

Português A ASUSTeK Computer Inc. declara que este dispositivo está em conformidade com os requisitos essenciais e outras disposições relevantes das Diretivas relacionadas. Texto integral da declaração da UE disponível em: www.asus.com/support

Română ASUSTeK Computer Inc. declară că acest dispozitiv se conformează cerințelor esențiale și altor prevederi relevante ale directivelor conexe. Textul complet al declarației de conformitate a Uniunii Europene se găsește la: www.asus.com/support

Srpski ASUSTeK Computer Inc. ovim izjavljuje da je ovaj uređaj u saglasnosti sa osnovnim zahtevima i drugim relevantnim odredbama povezanih direktiva. Pun tekst EU deklaracije o usaglasenosti je dostupan da adresi: www.asus.com/support

Slovensky Spoločnosť ASUSTeK Computer Inc. týmto vyhlasuje, že toto zariadenie vyhovuje základným požiadavkám a ostatným príslušným ustanoveniam príslušných smerníc. Celý text vyhlásenia o zhode pre štáty EÚ je dostupný na adrese: www.asus.com/support

Slovensčina ASUSTeK Computer Inc. izjavlja, da je ta naprava skladna z bistvenimi zahtevami in drugimi ustreznimi določbami povezanih direktiv. Celotno besedilo EU-izjave o skladnosti je na voljo na spletnem mestu: www.asus.com/support

Español Por la presente, ASUSTeK Computer Inc. declara que este dispositivo cumple los requisitos básicos y otras disposiciones pertinentes de las directivas relacionadas. El texto completo de la declaración de la UE de conformidad está disponible en: www.asus.com/support

Svenska ASUSTeK Computer Inc. förklarar härmed att denna enhet överensstämmer med de grundläggande kraven och andra relevanta föreskrifter i relaterade direktiv. Fulltext av EU-försäkran om överensstämmelse finns på: www.asus.com/support

Українська ASUSTeK Computer Inc. заявляє, що цей пристрій відповідає основним вимогам та іншим відповідним положенням відповідних Директив. Повний текст декларації відповідності стандартам ЄС доступний на: www.asus.com/support

Türkçe ASUSTeK Computer Inc., bu aygıtın temel gereksinimlerle ve ilişkinli Yönergelelerin diğer ilgili koşullarıyla uyumlu olduğunu beyan eder. AB uygunluk bildirimini tam metni şu adreste bulabilirsiniz: www.asus.com/support

Bosanski ASUSTeK Computer Inc. ovim izjavljuje da je ovaj uređaj uskladen sa bitnim zahtjevima i ostalim odgovarajućim odredbama vezanih direktiva. Cijeli tekst EU izjave o uskladenosti dostupan je na: www.asus.com/support

ASUS contact information

ASUSTeK COMPUTER INC.

Address 4F, No. 150, Li-Te Rd., Peitou, Taipei 112, Taiwan
Telephone +886-2-2894-3447
Fax +886-2-2890-7798
Web site <https://www.asus.com>

Technical Support

Telephone +86-21-38429911
Fax +86-21-58668722 ext: 9101
Online Support <https://www.asus.com/support/Product/ContactUs/Services/questionform/?lang=en>

ASUSTeK COMPUTER INC. (Taiwan)

Address 4F, No. 150, Li-Te Rd., Peitou, Taipei 112, Taiwan
Telephone +886-2-2894-3447
Fax +886-2-2890-7798
Web site <https://www.asus.com/tw/>

Technical Support

Telephone +886-2-2894-3447 (0800-093-456)
Online Support <https://www.asus.com/support/Product/ContactUs/Services/questionform/?lang=zh-tw>

ASUSTeK COMPUTER INC. (China)

Address No. 5077, Jindu Road, Minhang District, Shanghai, China
Telephone +86-21-5442-1616
Fax +86-21-5442-0099
Web site <https://www.asus.com.cn>

Technical Support

Telephone +86-20-2804-7506 (400-620-6655)
Online Support <https://www.asus.com/support/Product/ContactUs/Services/questionform/?lang=zh-cn>

ASUS contact information

ASUS COMPUTER INTERNATIONAL (America)

Address 800 Corporate Way, Fremont, CA 94539, USA
Fax +1-510-608-4555
Web site <https://www.asus.com/us/>

Technical Support

Support fax +1-812-284-0883
General support +1-812-282-2787
Online support <https://www.asus.com/support/Product/ContactUs/Services/questionform/?lang=en-us>

ASUS COMPUTER GmbH (Germany and Austria)

Address Harkort Str. 21-23, 40880 Ratingen, Germany
Fax +49-2102-959911
Web site <https://www.asus.com/de/>

Technical Support

Telephone +49-1805-010923
Support Fax +49-2102-959911
Online support <https://www.asus.com/support/Product/ContactUs/Services/questionform/?lang=de-de>

ASUS Czech Service s.r.o. (Europe)

Address Na Rovince 887, 720 00 Ostrava – Hrabová,
Czech Republic
Telephone +420-596766888
Web site <https://www.asus.com/cz/>

Technical Support

Telephone +420-596-766-891
Fax +420-596-766-329
E-mail advance.rma.eu@asus.com
Online Support <https://www.asus.com/support/Product/ContactUs/Services/questionform/?lang=cs-cz>

ASUS contact information

ASUS Holland BV (The Netherlands)

Address Marconistraat 2, 7825GD EMMEN, The Netherlands
Web site <https://www.asus.com/nl/>

Technical Support

Telephone +31-(0)591-5-70292
Fax +31-(0)591-666853
E-mail advance.rma.eu@asus.com
Online Support <https://www.asus.com/support/Product/ContactUs/Services/questionform/?lang=nl-nl>

ASUS Polska Sp. z o.o. (Poland)

Address Ul. Postępu 6, 02-676 Warszawa, Poland
Web site <https://www.asus.com/pl/>

Technical Support

Telephone +48-225718033
Online Support <https://www.asus.com/support/Product/ContactUs/Services/questionform/?lang=pl-pl>

ASK-Service (Russia and CIS)

Address г.Москва, ул. Орджоникидзе, д.10, Россия
Telephone (495) 640-32-75
Web site <https://www.asus.com/ru/>

Technical Support

Telephone 008-800-100-ASUS (008-800-100-2787)
Online Support <https://www.asus.com/support/Product/ContactUs/Services/questionform/?lang=ru-ru>

DECLARATION OF CONFORMITY

Per FCC Part 2 Section 2. 1077(a)



Responsible Party Name: **Asus Computer International**

Address: **800 Corporate Way, Fremont, CA 94539.**

Phone/Fax No: **(510)739-3777/(510)608-4555**

hereby declares that the product

Product Name : Motherboard

Model Number : P10S-M

Conforms to the following specifications:

FCC Part 15, Subpart B, Unintentional Radiators

Supplementary Information:

This device complies with part 15 of the FCC Rules. Operation is subject to the following two conditions: (1) This device may not cause harmful interference, and (2) this device must accept any interference received, including interference that may cause undesired operation.

Representative Person's Name : Steve Chang / President

A handwritten signature in blue ink that reads "Steve Chang". The signature is written in a cursive style and is placed over a light blue rectangular background.

Signature :

Date : Mar. 04, 2015

Ver. 140331

